

Common Mode Noise Filters

EXC14CT type

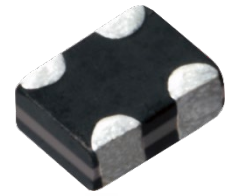

Features

- Small and thin (L 0.85 mm×W 0.65 mm×H 0.45 mm)
- High attenuation at common-mode for noise suppression of harmonic signal components and cellular frequency
- High cut-off frequency and capability of coping with high-speed signals (HDMI)
- Strong multilayer/sintered structure, excellent reflow resistance and high mounting reliability
- RoHS compliant

Recommended applications

- Smartphones, Tablet PCs and DSC
- Noise suppression of high-speed differential data lines such as MIPI, LVDS

Explanation of part numbers

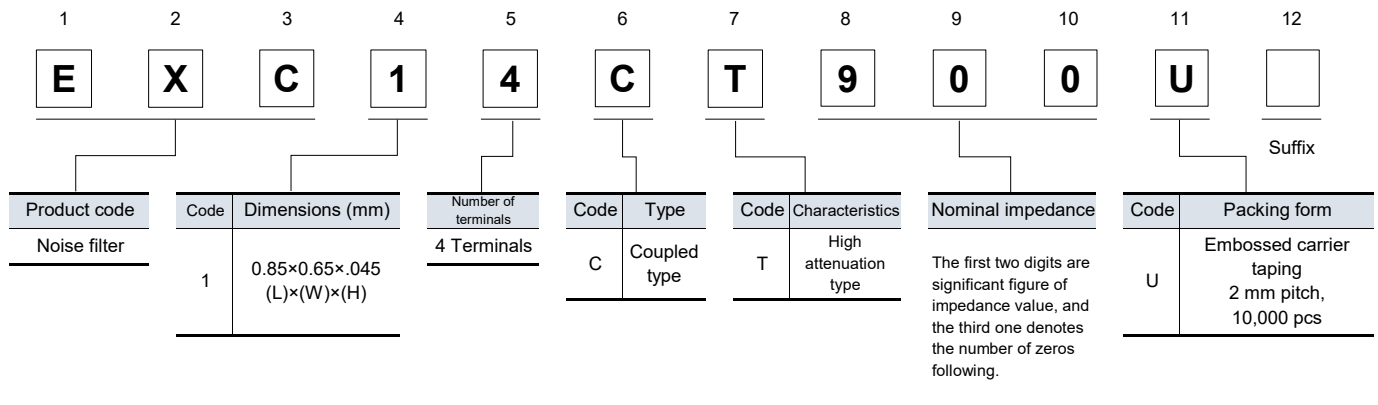

Construction

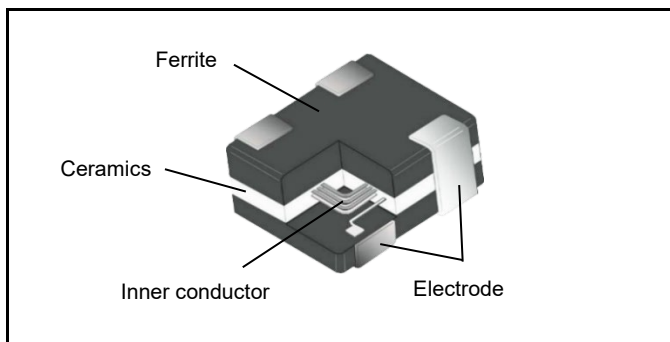

Circuit configuration (No polarity)

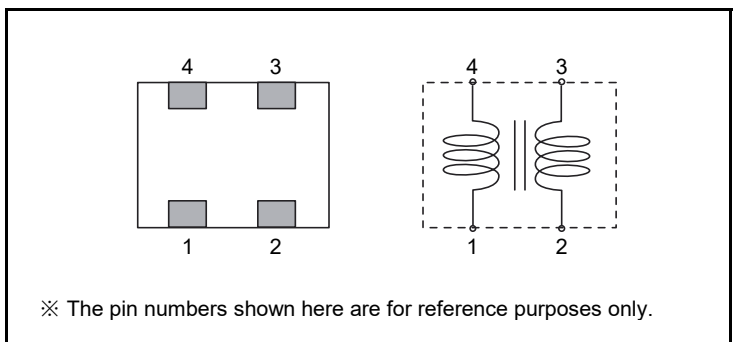

Dimensions in mm (not to scale)

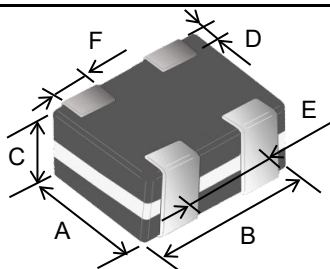

Unit : mm

Part No. (inch size)	Dimensions						Mass (Weight) (mg/ pc.)
	A	B	C	D	E	F	
EXC14CT (0302)	0.65 ± 0.05	0.85 ± 0.05	0.45 ± 0.05	0.10 min.	0.50 ± 0.10	0.27 ± 0.10	1.0

Ratings

Part number	Impedance (Ω) at 100 MHz		Rated voltage (V) DC	Rated current (mA) DC	DC resistance (Ω)
	Common mode	Differential mode			
EXC14CT500U	50 $\Omega \pm 25\%$	17 Ω max.	5	100	2.3 $\Omega \pm 30\%$
EXC14CT900U	90 $\Omega \pm 20\%$	20 Ω max.	5	100	3.3 $\Omega \pm 30\%$

● Category temperature range $-40\text{ }^{\circ}\text{C}$ to $+85\text{ }^{\circ}\text{C}$

Impedance characteristics (Typical)

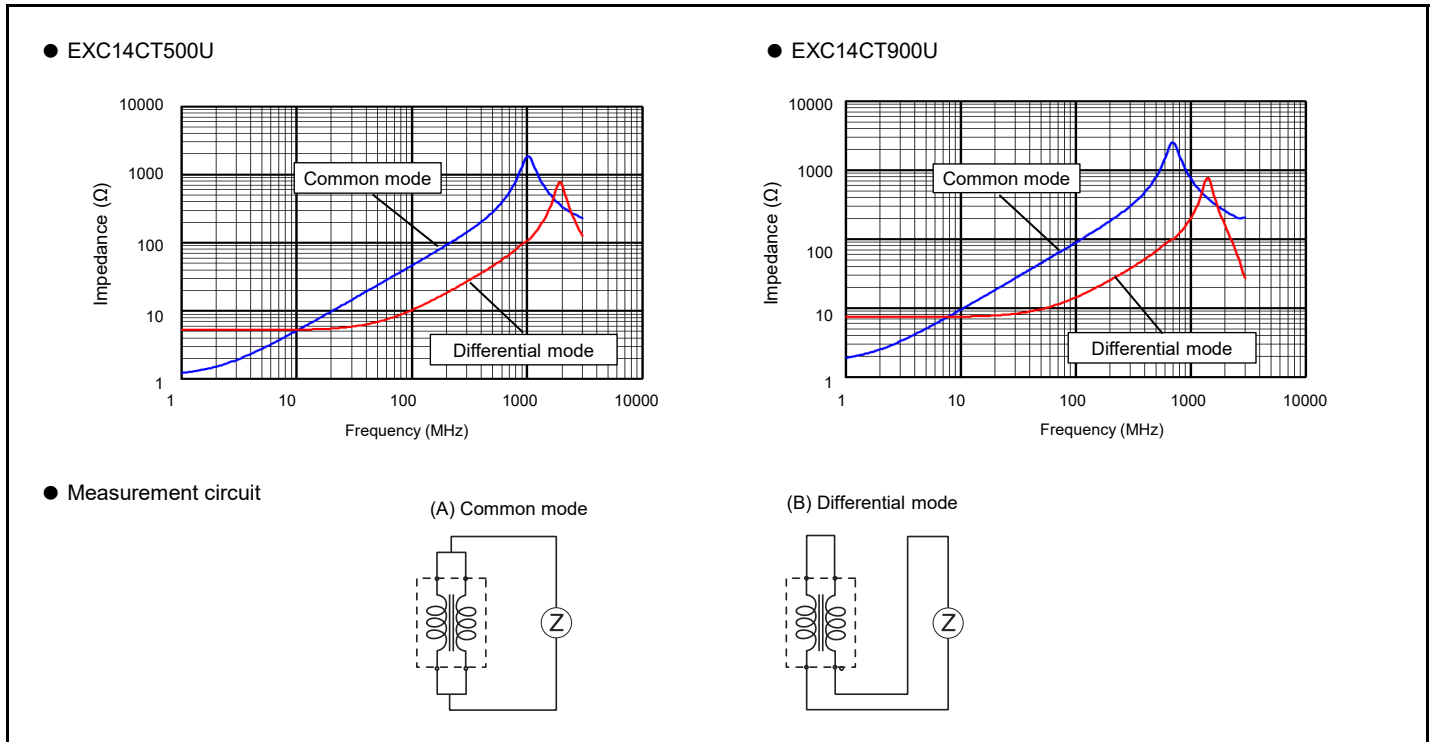

Common mode attenuation characteristics (Scc21), differential mode insertion loss characteristics (Sdd21) (reference data)

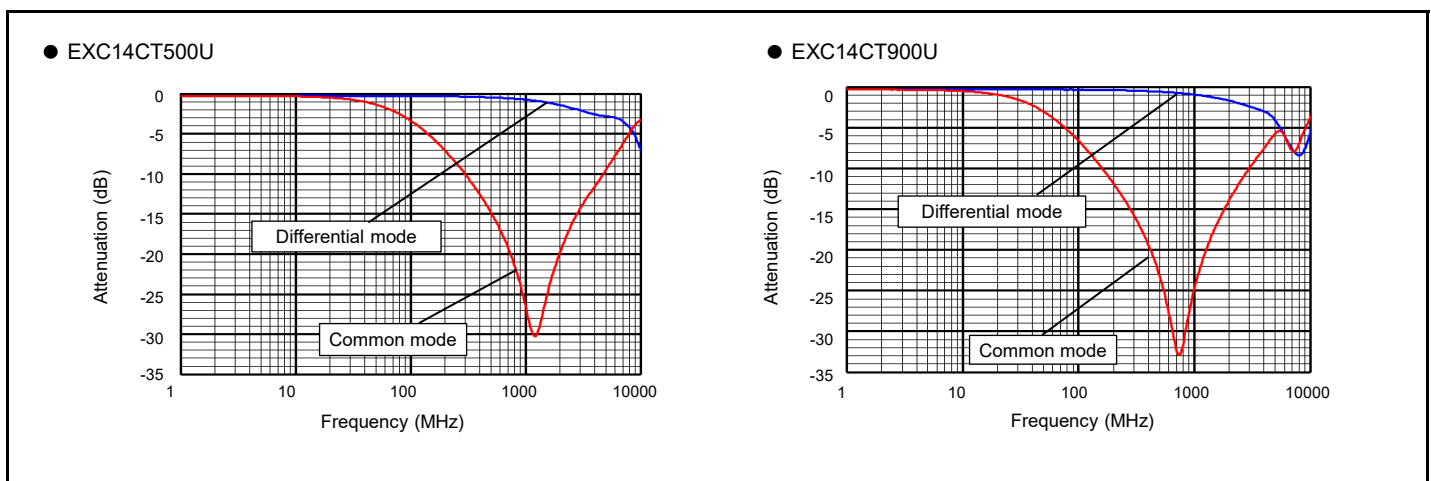

■ As for packaging methods, soldering conditions and safety precautions, please see data files

Common Mode Noise Filters / Common performance

Performance		
Test item	Performance requirements	Test conditions resistance
Resistance	Within specified tolerance	25 °C
Overload	—	Rated voltage
Resistance to soldering heat	±30 % (Impedance change)	260 °C, 10 s
Rapid change of temperature	±30 % (Impedance change)	-40 °C (30 min.) / +85 °C (30 min.), 200 cycles
High temperature exposure	±30 % (Impedance change)	85 °C , 500 h
Damp heat, Steady state	±30 % (Impedance change)	60 °C, 95 %RH, 500 h
Load life in humidity	±30 % (Impedance change)	60 °C, 95 %RH, Rated current, 500 h

Guidelines and precautions regarding the technical information and use of our products described in this online catalog.

- If you want to use our products described in this online catalog for applications requiring special qualities or reliability, or for applications where the failure or malfunction of the products may directly jeopardize human life or potentially cause personal injury (e.g. aircraft and aerospace equipment, traffic and transportation equipment, combustion equipment, medical equipment, accident prevention, anti-crime equipment, and/or safety equipment), it is necessary to verify whether the specifications of our products fit to such applications. Please ensure that you will ask and check with our inquiry desk as to whether the specifications of our products fit to such applications use before you use our products.
- The quality and performance of our products as described in this online catalog only apply to our products when used in isolation. Therefore, please ensure you evaluate and verify our products under the specific circumstances in which our products are assembled in your own products and in which our products will actually be used.
- Please ensure the safety by means of protection circuit, redundant circuit etc. in your system design in order to prevent the occurrence of life crisis and other serious damages due to the failure of our products.
- The products and product specifications described in this online catalog are subject to change for improvement without prior notice. Therefore, please be sure to request and confirm the latest product specifications which explain the specifications of our products in detail, before you finalize the design of your applications, purchase, or use our products.
- The technical information in this online catalog provides examples of our products' typical operations and application circuits. We do not guarantee the non-infringement of third party's intellectual property rights and we do not grant any license, right, or interest in our intellectual property.
- If any of our products, product specifications and/or technical information in this catalog is to be exported, the laws and regulations of the exporting country, especially with regard to security and export control, shall be observed.

<Regarding the Certificate of Compliance with the EU RoHS Directive/REACH Regulations>

- The switchover date for compliance with the RoHS Directive/REACH Regulations varies depending on the part number or series of our products.
- When you use the inventory of our products for which it is unclear whether those products are compliant with the RoHS Directive/REACH Regulation, please select "Sales Inquiry" in the website inquiry form and contact us.

Please note that we do not owe any liability and responsibility if our products are used beyond the description of this catalog or without complying with precautions in this catalog.



Application Guidelines

(Common Mode Noise Filters/Array,
Common Mode Noise Filters/Array with ESD Suppressor, 2 Mode Noise Filters)

1. Safety precautions

- Make sure to exchange product specifications before using this product, regardless of the intended use. The design and specifications in this catalog are subject to change without prior notice.
- Do not use the products beyond the specifications described in this catalog.
- This catalog explains the quality and performance of the products as individual components. Before use, check and evaluate their operations when installed in your products.
- If a malfunction of this product may result in the loss of human life or other serious damage in transportation equipment (trains, automobiles, ships, etc.), signaling equipment, medical equipment, aerospace equipment, electric heating equipment, combustion and gas equipment, rotating equipment, disaster prevention and security equipment, and other equipment, ensure safety by implementing a fail-safe design with the following system.
 - * Systems equipped with a protection circuit and a protection device.
 - * Systems equipped with a redundant circuit or other system to prevent an unsafe status in the event of a single fault.

2. Precautions for use

- These products are designed and manufactured for general and standard use in general electronic equipment (e.g. AV equipment, home electric appliances, office equipment, information and communication equipment). If the product is to be used in an application that requires special quality and reliability and where failure or malfunction of the product may directly threaten human life or cause bodily harm (e.g., aerospace equipment, transportation equipment, combustion equipment, medical equipment, disaster prevention and security equipment, safety devices, etc.), be sure to consult with our sales office in advance and exchange product specifications appropriate for the application.
- These products are not intended for use in the following special conditions. Before using the products, carefully check the effects on their quality and performance, and determine whether or not they can be used.
 1. In liquid, such as water, oil, chemicals, or organic solvent.
 2. In direct sunlight, outdoors, or in dust.
 3. In salty air or air with a high concentration of corrosive gas, such as Cl_2 , H_2S , NH_3 , SO_2 , or NO_x .
 4. Electric Static Discharge (ESD) Environment.
These components are sensitive to static electricity and can be damaged under static shock (ESD). Please take measures to avoid any of these environments. Smaller components are more sensitive to ESD environment.
 5. Electromagnetic and Radioactive Environment.
Avoid any environment where strong electromagnetic waves and radiation exist.
 6. In an environment where these products cause dew condensation.
 7. Sealing or coating of these products or a printed circuit board on which these products are mounted, with resin or other materials.
- These products generate Joule heat when energized. Carefully position these products so that their heat will not affect the other components.
- Carefully position these products so that their temperatures will not exceed the category temperature range due to the effects of neighboring heat-generating components. Do not mount or place heat-generating components or inflammables, such as vinyl-coated wires, near these products.
- Note that non-cleaning solder, halogen-based highly active flux, or water-soluble flux may deteriorate the performance or reliability of the products.
- Carefully select a flux cleaning agent for use after soldering. An unsuitable agent may deteriorate the performance or reliability. In particular, when using water or a water-soluble cleaning agent, be careful not to leave water residues. Otherwise, the insulation performance may be deteriorated.
- Do not apply flux to these products after soldering. The activity of flux may be a cause of failures in these products.
- Refer to the recommended soldering conditions and set the soldering condition. High peak temperature or long heating time may impair the performance or the reliability of these products.
- Recommended soldering condition is for the guideline for ensuring the basic characteristics of the products, not for the stable soldering conditions. Conditions for proper soldering should be set up according to individual conditions.
- Do not reuse any products after removal from mounting boards.
- Do not drop these products. If these products are dropped, do not use them. Such products may have received mechanical or electrical damage.
- If any doubt or concern to the safety on these products arise, make sure to inform us immediately and conduct technical examinations at your side.

3. Precautions for storage

The performance of these products, including the solderability, is guaranteed for a year from the date of arrival at your company, provided that they remain packed as they were when delivered and stored at a temperature of -5 °C to +40 °C and a relative humidity of 15 % to 75 %.

Even within the above guarantee periods, do not store these products in the following conditions. Otherwise, their electrical performance and/or solderability may be deteriorated, and the packaging materials (e.g. taping materials) may be deformed or deteriorated, resulting in mounting failures.

1. In salty air or in air with a high concentration of corrosive gas, such as Cl₂, H₂S, NH₃, SO₂, or NO_x.
2. In direct sunlight.

<Package markings>

Package markings include the product number, quantity, and country of origin.

In principle, the country of origin should be indicated in English.

4. Precaution specific to this product

1. Use rosin-based flux or halogen-free flux.
2. For cleaning, use an alcohol-based cleaning agent. Before using any other type, consult with our sales person in advance.
3. Mounting of the suppressors with excessive or insufficient wetting amount of solder may affect the connection reliability or the performance of the suppressors. Carefully check the effects and apply a proper amount of solder for use.
4. Do not apply shock to Filters or pinch them with a hard tool (e.g. pliers and tweezers). Otherwise, their bodies may be chipped, affecting their performance. Excessive mechanical stress may damage the filters. Handle with care.
7. Avoid excessive bending of printed circuit boards in order to protect the suppressors from abnormal stress.
8. Do not immerse the suppressors in solvent for a long time. Before using solvent, carefully check the effects of immersion.
9. Do not apply excessive tension to the terminals.