

Device Features

- OIP3 = 41.0 dBm @ 140 MHz
- Gain = 16.0 dB @ 140 MHz
- Output P1 dB = 20.5 dBm @ 140 MHz
- NF = 3.2 @ 140MHz at Demo Board
- RoHS2-compliant SOT-89 SMT package



Product Description

BeRex's BIG2 is a high performance InGaP/ GaAs HBT MMIC amplifier, internally matched to 50 Ohms. The BIG2 is designed for high linearity IF amplifier that require excellent gain, high OIP3 and flatness. It is packaged in a RoHS2-compliant with SOT-89 surface mount package.

Applications

- Base station Infrastructure/RFID
- Commercial/Industrial

Applications Circuit

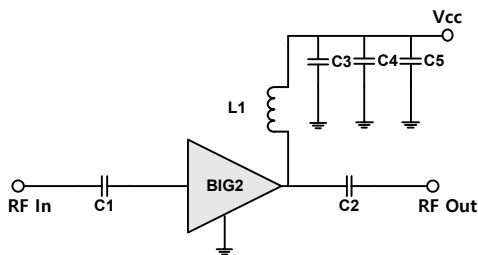

*C1, C2, =330 pF ± 5%; C3= 100 pF ± 5%; C4 = 1000 pF ± 5%

* C5 = 10uF ± 10%; L1 = 560nH ±10%

Electrical Specifications

Device performance _ measured on a BeRex evaluation board at 25°C, Vc=5V, 50 Ω system.

Parameter	Conditions	Min	Typ	Max	Unit
Operational Frequency Range		30		600	MHz
Test Frequency			140		MHz
Gain		14.5	16.0		dB
Input Return Loss			-22.5		dB
Output Return Loss			-13.5		dB
Output IP3	8 dBm / tone , Δf=1 MHz	38.0	41.0		dBm
Output P1dB		19.5	20.5		dBm
Noise Figure			3.2		dB

Recommended Operating Conditions

Parameter	Min	Typ	Max	Unit
Bandwidth	30		600	MHz
I _c @ (V _c = 5V)	67	84	101	mA
V _c	4.0	5.0	5.25	V
dG/dT		-0.002		dB/°C
R _{TH}		55.9		°C/W
Operating Case Temperature	-40		+85	°C

Electrical specifications are measured at specified test conditions.

Specifications are not guaranteed over all recommended operating conditions.

Absolute Maximum Ratings

Parameter	Rating	Unit
Storage Temperature	-55 to +155	°C
Junction Temperature	+175	°C
Supply Voltage	+7.0	V
Supply Current	180	mA
Input RF Power	24	dBm

Operation of this device above any of these parameters may result in permanent damage.

Application Circuit: 70-500 MHz

Typical Performance (Vd = 5V, Ic = 83mA, T = 25°C)

Freq	MHz	70	140	200	500
S21	dB	15.6	15.8	15.9	15.9
S11	dB	-19.6	-22.6	-22.4	-17.4
S22	dB	-13.1	-13.5	-14.1	-15.0
P1	dBm	20.3	20.7	20.9	20.0
OIP3	dBm	40.0	41.5	40.1	38.2
NF	dB	3.3	3.3	3.3	3.2

Typical Performance (Vd = 4.7V, Ic = 74mA, T = 25°C)

Freq	MHz	70	140	200	500
S21	dB	15.6	15.8	15.8	15.8
S11	dB	-19.9	-23.1	-22.7	-17.4
S22	dB	-13.0	-13.4	-14.0	-14.9
P1	dBm	19.4	19.6	19.8	19.2
OIP3	dBm	38.3	40.3	38.0	36.7
NF	dB	3.3	3.3	3.2	3.2

Typical Performance (Vd = 4.5V, Ic = 68mA, T = 25°C)

Freq	MHz	70	140	200	500
S21	dB	15.6	15.7	15.8	15.8
S11	dB	-20.2	-23.5	-23.0	-17.5
S22	dB	-13.0	-13.4	-14.0	-14.9
P1	dBm	18.6	18.8	18.9	18.6
OIP3	dBm	38.0	38.5	37.5	35.5
NF	dB	3.2	3.2	3.1	3.1

Typical Performance (Vd = 4V, Ic = 53mA, T = 25°C)

Freq	MHz	70	140	200	500
S21	dB	15.5	15.6	15.7	15.7
S11	dB	-21.2	-25.2	-24.1	-17.7
S22	dB	-12.7	-13.1	-13.8	-14.7
P1	dBm	16.5	16.5	16.4	16.2
OIP3	dBm	33.5	32.9	31.6	31.5
NF	dB	3.1	3.1	3.0	3.0

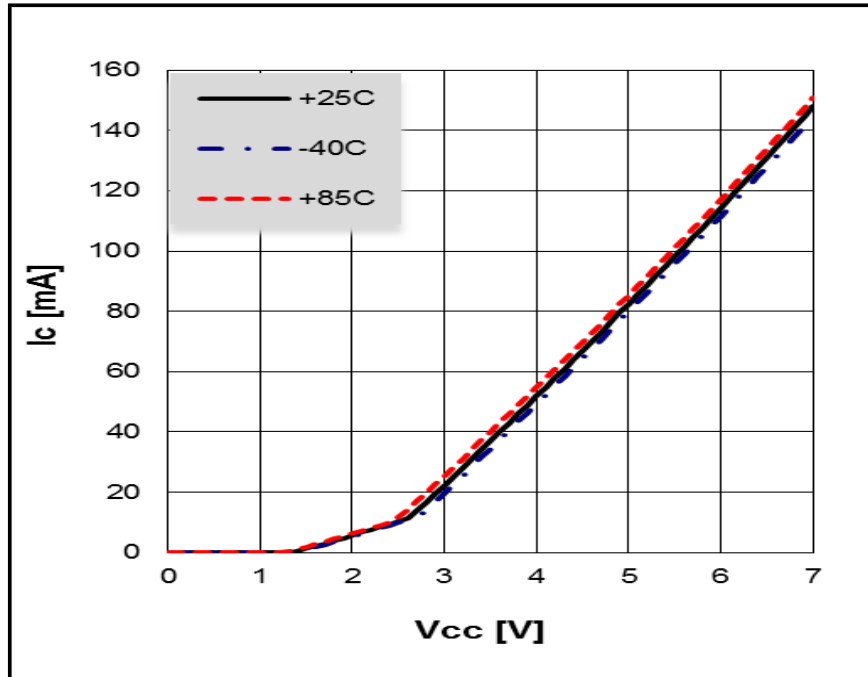
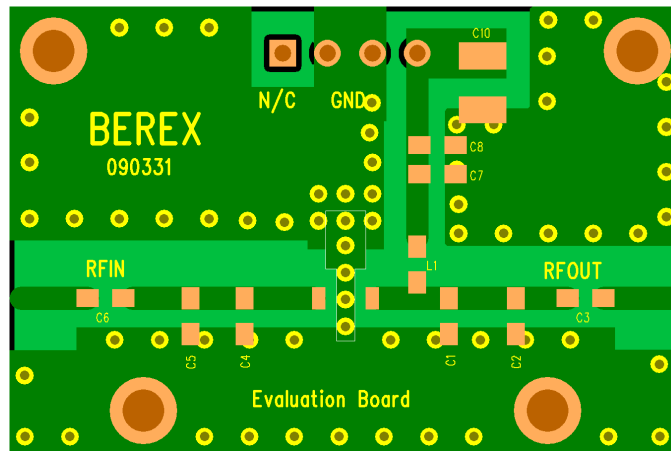
V-I Characteristics

BeRex SOT89 Evaluation Board

*Dielectric constant _ 4.2 *RF pattern width 52mil *31mil thick FR4 PCB

Typical Device Data

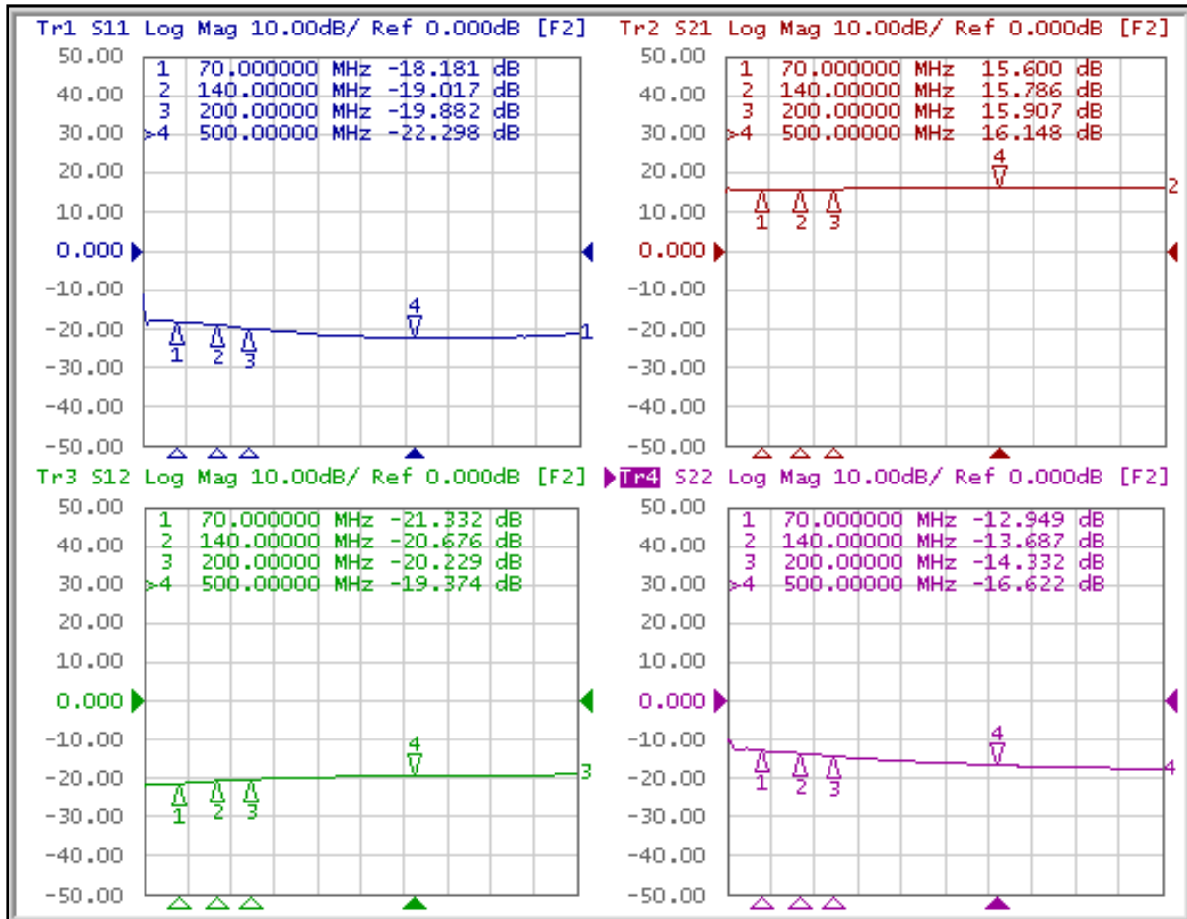
S-parameters (Vc=5V, Ic=84mA, T=25°C)



S-Parameter

(Vdevice = 5.0V, Icc = 84mA, T = 25 °C, calibrated to device leads)

Freq	S11	S11	S21	S21	S12	S12	S22	S22
	[Mag]	[Ang]	[Mag]	[Ang]	[Mag]	[Ang]	[Mag]	[Ang]
100	0.118	161.079	0.088	6.932	6.080	178.471	0.219	-36.430
200	0.101	147.131	0.097	7.639	6.242	175.131	0.192	-63.246
300	0.087	134.988	0.103	6.110	6.340	171.053	0.172	-80.582
400	0.081	125.136	0.106	4.916	6.390	167.388	0.156	-93.145
500	0.077	112.538	0.107	3.755	6.415	163.578	0.148	-100.771
600	0.076	97.304	0.109	2.749	6.423	159.524	0.141	-106.078

Typical Performance

($V_d = 5V$, $I_c = 83mA$, $T = 25^\circ C$)

Pin-Pout-Gain

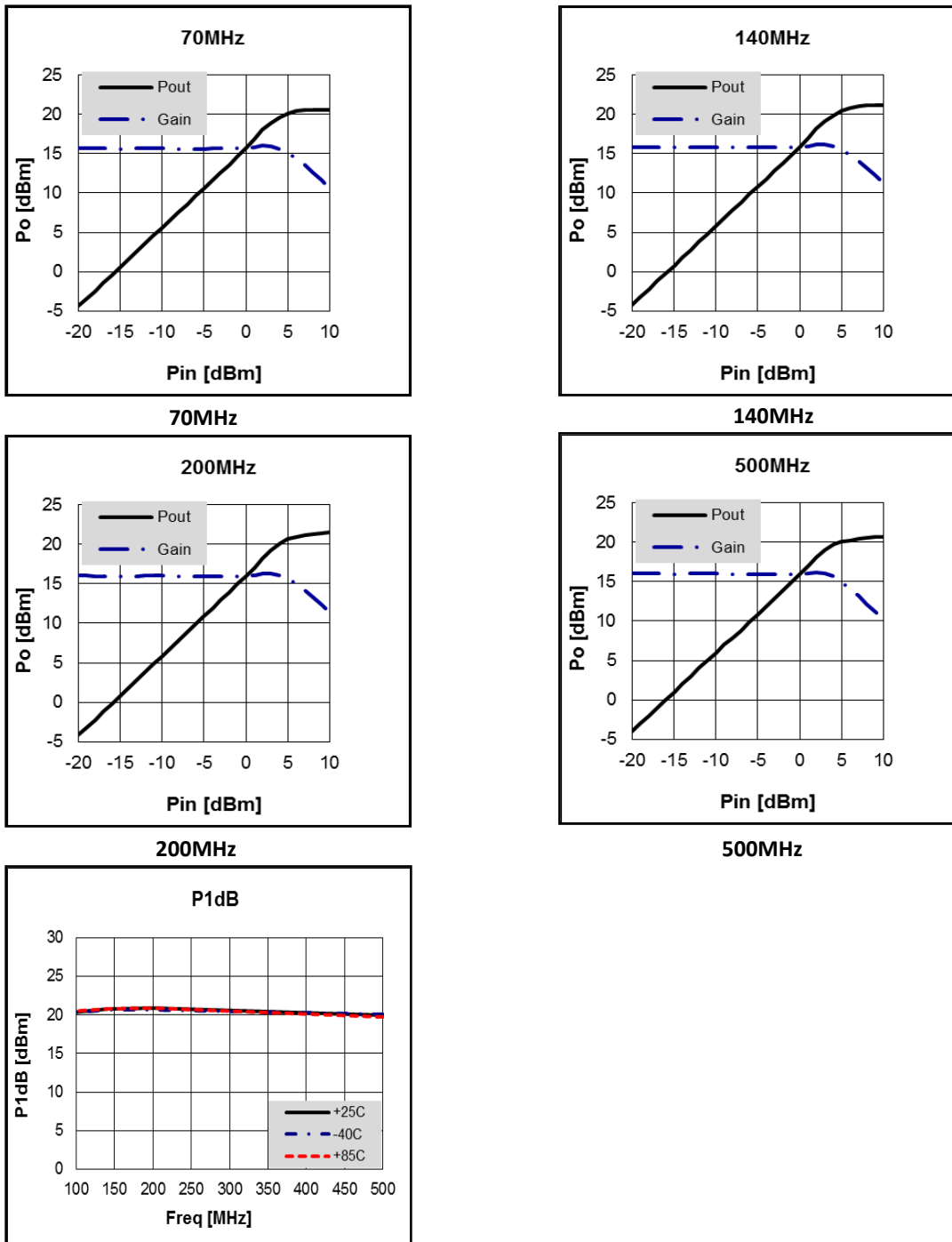

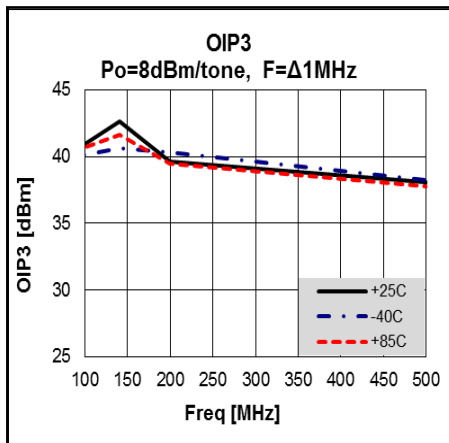
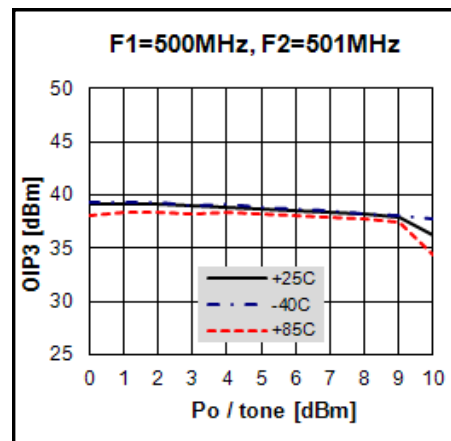
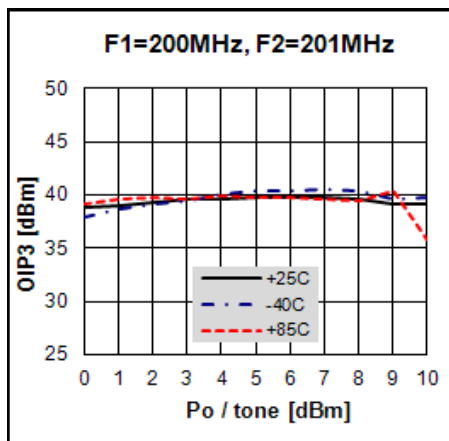
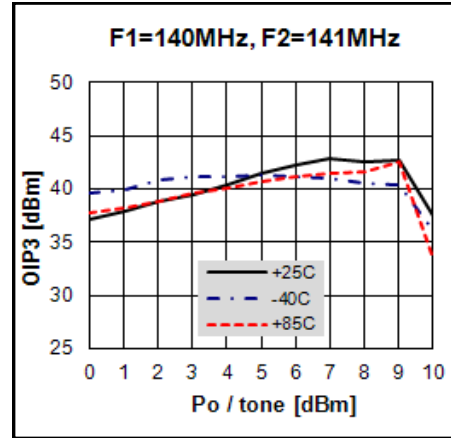
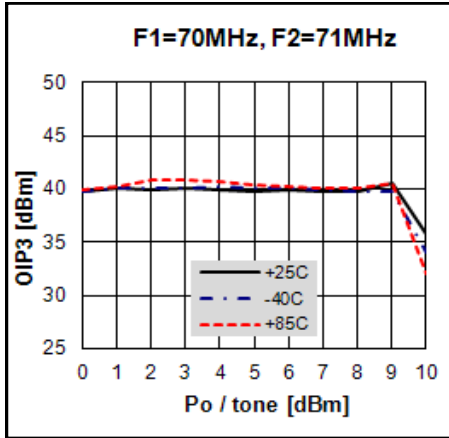
OIP3

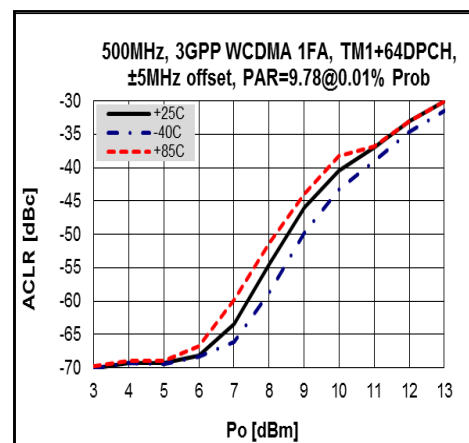
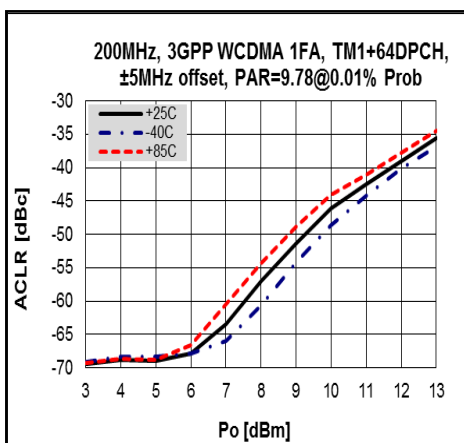
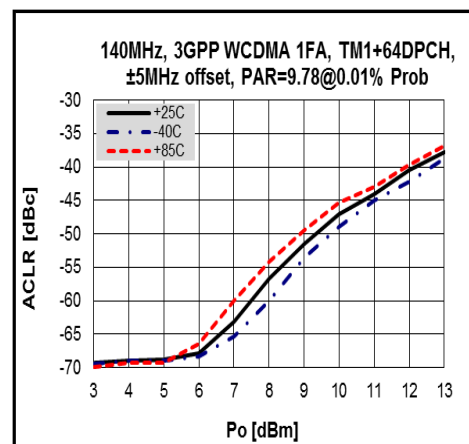
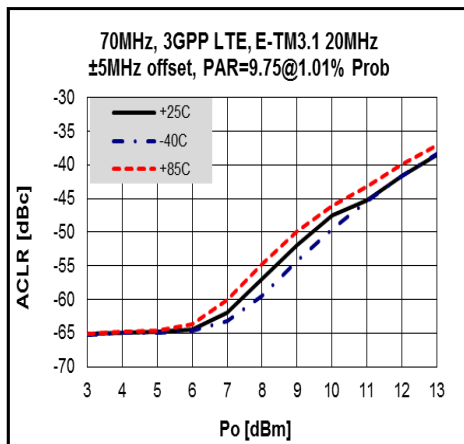
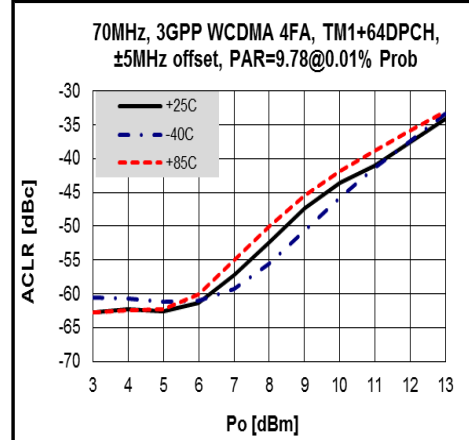
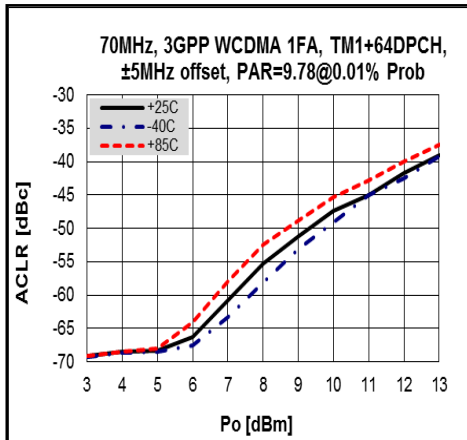
ACLR / LTE

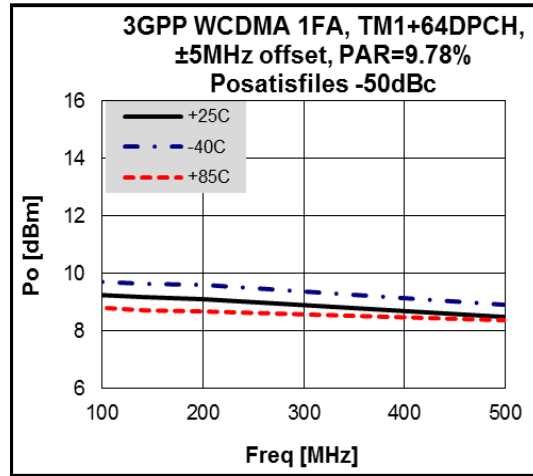

S-Parameters over Temperature

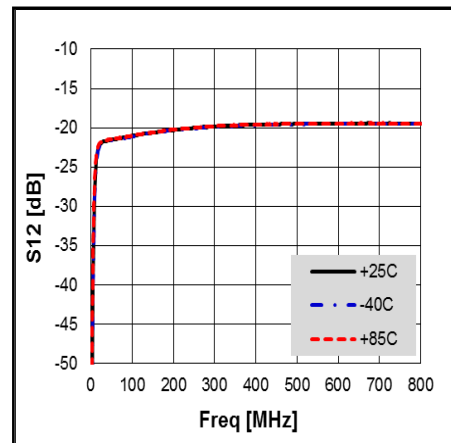
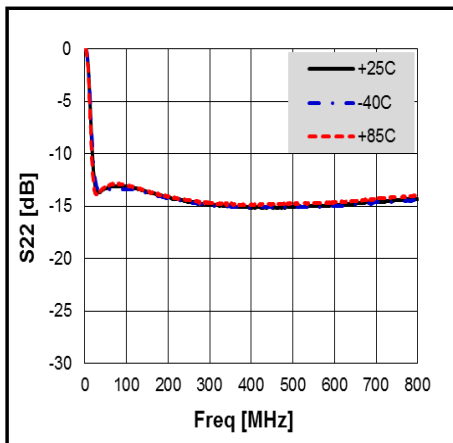
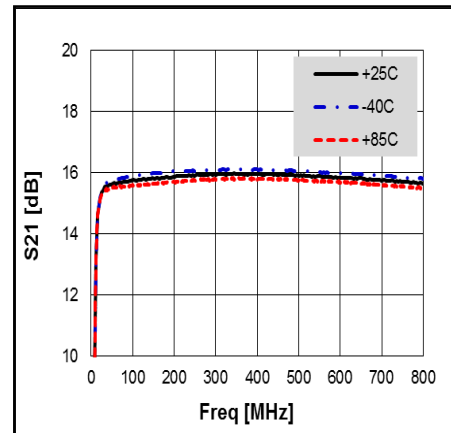
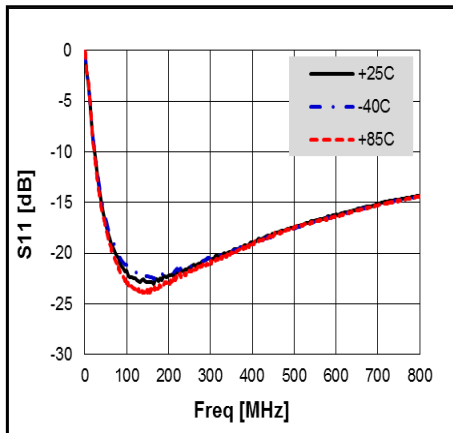

Package Outline Dimension

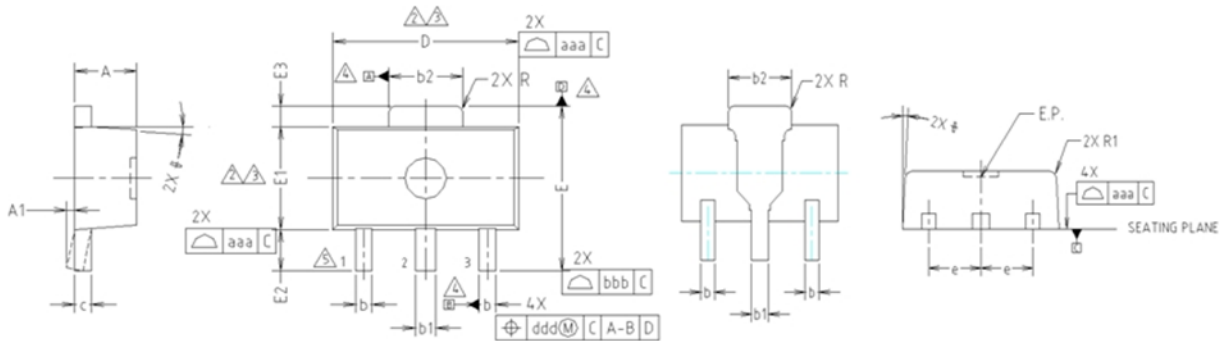

- NOTE:**
 1. DIMENSIONS IN MILLIMETERS.
- ⚠ DIMENSION D DOES NOT INCLUDE MOLD FLASH, PROTRUSIONS OR GATE BURRS. MOLD FLASH, PROTRUSIONS OR GATE BURRS SHALL NOT EXCEED 0.5mm PER END. DIMENSION E1 DOES NOT INCLUDE INTERLEAD FLASH OR PROTRUSION. INTERLEAD FLASH OR PROTRUSION SHALL NOT EXCEED 0.5mm PER SIDE.
 - ⚠ DIMENSIONS D AND E1 ARE DETERMINED AT THE OUTMOST EXTREMES OF THE PLASTIC BODY EXCLUSIVE OF MOLD FLASH, TIE BAR BURRS, GATE BURRS AND INTERLEAD FLASH, BUT INCLUDING ANY MISMATCH BETWEEN THE TOP AND BOTTOM OF THE PLASTIC BODY.
 - ⚠ DATUMS A, B AND D TO BE DETERMINED 0.18mm FROM THE LEAD TIP.
 - ⚠ TERMINAL NUMBERS ARE SHOWN FOR REFERENCE ONLY.

SYMBOL	MILLIMETERS			NOTE
	MINIMUM	NOMINAL	MAXIMUM	
A	1.40	1.50	1.60	
A1	0.00	—	0.10	
b	0.38	0.42	0.48	
b1	0.48	0.52	0.58	
b2	1.79	1.82	1.87	
c	0.40	0.42	0.46	
D	4.40	4.50	4.70	2,3
E	3.70	4.00	4.30	
E1	2.40	2.50	2.70	2,3
E2	0.80	1.00	1.20	
E3	0.40	0.50	0.60	
e	1.50 TYP.			
φ	4° TYP.			
R	0.15 TYP.			
R1	—	—	0.20	
SYMBOL	TOLERANCES OF FORM AND POSITION		NOTE	
aaa	0.15			
bbb	0.20			
ccc	0.10			
ddd	0.10			

Suggested PCB Land Pattern and PAD Layout

PCB Land Pattern

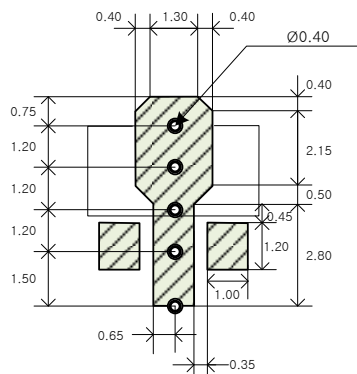

Note : All dimension _ millimeters

PCB lay out _ on BeRex website

PCB Mounting

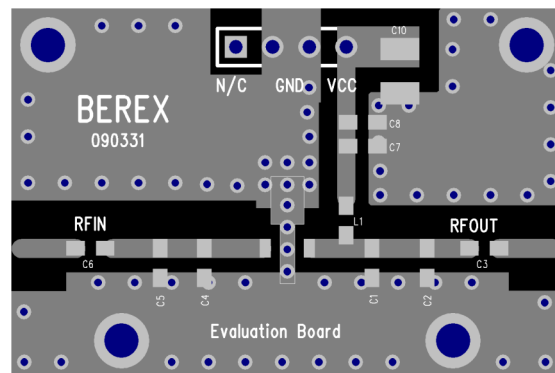

Package Marking

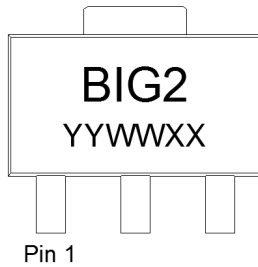

YY = Year, WW = Working Week,
XX = Wafer No.

Tape & Reel

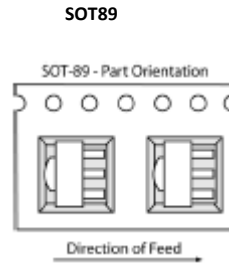

Packaging information:

Tape Width (mm): 12
Reel Size (inches): 7
Device Cavity Pitch (mm): 8
Devices Per Reel: 1000

Lead plating finish

100% Tin Matte finish

(All BeRex products undergoes a 1 hour, 150 degree C, Anneal bake to eliminate thin whisker growth concerns.)

MSL / ESD Rating

ESD Rating:	Class 1C
Value:	Passes <2000V
Test:	Human Body Model (HBM)
Standard:	JEDEC Standard JS-001-2012
MSL Rating:	Level 1 at +260°C convection reflow
Standard:	JEDEC Standard J-STD-020



Proper ESD procedures should be followed when handling this device.

RoHS Compliance

This part is compliant with Restrictions on the Use of Certain Hazardous Substances in Electrical and Electronic Equipment (RoHS) Directive 2011/65/EU as amended by Directive 2015/863/EU.

This product also is compliant with a concentration of the Substances of Very High Concern (SVHC) candidate list which are contained in a quantity of less than 0.1%(w/w) in each components of a product and/or its packaging placed on the European Community market by the BeRex and Suppliers.

NATO CAGE code:

2	N	9	6	F
---	---	---	---	---