

ARTESYN

ADO300-48S05 SERIES

300 Watts 1/8 Brick Converter



PRODUCT DESCRIPTION

Advanced Energy's Artesyn ADO300-48S05 series is a new generation single output digital control DC/DC converter with standard eighth-brick outline and pin configuration, as well as baseplate and PMBus™ option. It delivers up to 60A output current with 5V output voltage. Above 95.2% ultra-high efficiency and excellent thermal performance make it an ideal choice to supply power in telecom and data com. It can work under -40°C to +85°C with air cooling. PMBus™ optional interface is also provided for a flexible digital control.

SPECIAL FEATURES

- Delivers up to 60A output current
- Ultra-high efficiency 95.2% at half load
- Startup Pre-bias
- Excellent thermal performance
- Power Good (PG) feature
- No minimum load requirement
- RoHS Directive(EU) 2015/863 (RoHS 3.0)
- Remote control function (negative logic with Secondary Remote On/Off control optional)
- Remote output sense
- Trim from 4V to 5.7V
- PMBus Rev.1.2 Compliance
- Input under voltage lockout
- Input over voltage lockout
- Output over current protection
- Output over voltage protection
- Over temperature protection
- Industry standard eighth-brick pin-out outline
- Open frame and with baseplate optional
- Pin length option: 3.8mm

SAFETY

- TUV-SUD EN 62368-1
- UL+CUL UL 60950-1
- CE EN 62368-1

TYPICAL APPLICATIONS

- Datacom
- Telecom

AT A GLANCE

Total Power

300 Watts

Input Voltage

36 to 75 Vac

of Outputs

Single



MODEL NUMBERS

Standard	Output Voltage	Structure	Pin Type	RoHS Status	PMBus™
ADO300-48S05-6L	5Vdc	Open frame	Negative	RoHS 3.0	Don't support
ADO300-48S05-6LI	5Vdc	Open frame	Negative	RoHS 3.0	Support
ADO300-48S05B-6L	5Vdc	Baseplated	Negative	RoHS 3.0	Don't support
ADO300-48S05B-6LI	5Vdc	Baseplated	Negative	RoHS 3.0	Support
ADO300-48S05PB-6L	5Vdc	Baseplated	Positive	RoHS 3.0	Don't support

Order Information

ADO300	-	48	S	05			-	6	L	I
①		②	③	④	⑤	⑥		⑦	⑧	⑨

①	Model series	ADO: high efficiency digital control eighth brick series 300: output current: 60A
②	Input voltage	48: 36V ~ 75V input range, rated input voltage 48V
③	Output number	S: single output
④	Rated output voltage	05: 5V output
⑤	Remote ON/OFF logic	Default: negative; P: positive logic
⑥	Baseplate	B: with baseplate; default: open frame
⑦	Pin length	4: 4.8mm ± 0.25mm 6: 3.8mm ± 0.25mm 8: 2.8mm ± 0.25mm Default: 5.8mm ± 0.25mm
⑧	RoHS status	L: RoHS 3.0
⑨	PMBus interface	I: available; default: don't support

Options

Positive enable optional

Pin length optional

PMBus optional

ELECTRICAL SPECIFICATIONS

Absolute Maximum Ratings

Stress in excess of those listed in the “Absolute Maximum Ratings” may cause permanent damage to the power supply. These are stress ratings only and functional operation of the unit is not implied at these or any other conditions above those given in the operational sections of this TRN. Exposure to any absolute maximum rated condition for extended periods may adversely affect the power supply’s reliability.

Table 1. Absolute Maximum Ratings						
Parameter	Model	Symbol	Min	Typ	Max	Unit
Input Voltage	All	$V_{IN,DC}$	-	-	80	Vdc
			-	-	100	Vdc
Maximum Output Power	All	$P_{O,max}$	-	-	300	W
Isolation Voltage ¹	All		-	-	1500	Vdc
	All		10	-	-	Mohm
Ambient Operating Temperature	All	T_A	-40	-	85	°C
Storage Temperature	All	T_{STG}	-55	-	125	°C
Voltage at Remote ON/OFF Pin	All		-0.3	-	15	Vdc
Logic Pin Voltage (to Sig_Gnd or Vo-), such as Trim/C1, C2, Addr0, Addr1, Clock, Data or SMBAlert	All		-	-	3.3	Vdc
Humidity (non-condensing)	All		-	-	95	%
	All		-	-	95	%

Note 1 - Basic insulation, pollution degree 2, 1mA for 60s, slew rate of 1500V/10s.

ELECTRICAL SPECIFICATIONS

Input Specifications

Table 2. Input Specifications						
Parameter	Condition ¹	Symbol	Min	Typ	Max	Unit
Operating Input Voltage, DC	All	$V_{IN,DC}$	36	48	75	Vdc
Turn-on Voltage Threshold	All	$V_{IN,ON}$	31	-	36	Vdc
Turn-off Voltage Threshold	All	$V_{IN,OFF}$	30	-	35	Vdc
Input Under-voltage Lockout Hysteresis	All		1	-	3	V
Input Over Voltage Protection	All	V_{IN}	79	-	87	V
Input Over Voltage Protection recovery voltage	All	V_{IN}	78	-	86	V
Input Over-voltage Lockout Hysteresis	All		1	-	-	V
Maximum Input Current	$V_{IN,DC}=36Vdc$ $I_O=I_{O,max}$	$I_{IN,max}$	-	-	9.15	A
No Load Input Current	$I_O=0A$	$I_{IN,no\ load}$	-	72	-	mA
Standby Input Current	Remote OFF	$I_{IN,standby}$	-	22	-	mA
Recommended Input Fuse ²			-	15	-	A
Recommended External Input Capacitance ³		C_{IN}	220	-	-	μF
Input Reflected Ripple Current ⁴ (rms)			-	20	-	mA
Efficiency ⁵	$V_{IN,DC}=48Vdc$ $I_O=I_{O,max}$ $I_O=50\%I_{O,max}$	η	-	94.6 95.2	-	% %
Input Filter Component Value(C\L)	Internal values		-	6.9\0.68	-	$\mu F\backslash\mu H$

Note 1 - $T_A=25^\circ C$, airflow rate=400LFM, $V_{IN,DC}=48Vdc$, nominal output voltage unless otherwise noted.

Note 2 - Fast blow external fuse recommended, see Figure 21.

Note 3 - Low ESR capacitor recommended.

Note 4 - Figure 1, Test condition: through 12 μH inductor, see Figure 13.

Note 5 - Figure 10, test condition: $T_A=25^\circ C$, air velocity: 800LFM.

ELECTRICAL SPECIFICATIONS

Output Specifications

Table 3. Output Specifications						
Parameter	Conditions ¹	Symbol	Min	Typ	Max	Unit
Output Voltage Factory Set Point (standard option)	$V_{IN,DC}=48Vdc,$ $I_O=50\%I_{O,max}$ $T_A=25^{\circ}C$	$V_{O,nom}$	4.95	5	5.05	Vdc
Output Voltage Line Regulation		V_O	-	-	± 25	mV
Output Voltage Load Regulation		V_O	-	-	± 25	mV
Output Voltage Temperature Regulation		$\%V_O$	-	-	0.02	$\%/^{\circ}C$
Output Voltage Ripple and Noise	$V_{IN,DC}=48Vdc,$ $I_O=I_{O,nom}$ $T_A=25^{\circ}C,$ air velocity: 400LFM		-	50	-	mVpk-pk
Output Voltage Ripple and Noise	$T_A=25^{\circ}C,$ air velocity: 400LFM, $V_{IN,DC}=48Vdc,$ $V_O=V_{O,nom}, I_O=I_{O,nom}$ Tan 10uF tantalum/1uF ceramic capacitor		-	180	-	mVpk-pk
Operating Output Current Range		I_O	0	-	60	A
Output DC current-limit inception ²		I_O	64	-	90	A
Output Capacitance ³		C_O	220	-	10000	μF
Output Voltage Trim Range	Via external resistor ⁴		4	-	5.7	V
	Via PMBus		4	-	5.7	V
Output Voltage Remote Sense Range			0	-	0.4	V

Note 1 - $T_A=25^{\circ}C$, airflow rate=400LFM, $V_{IN,DC}=48Vdc$, nominal output voltage unless otherwise noted.

Note 2 - Hiccup: auto-restart when over current condition is removed.

Note 3 - 100 μF ceramic capacitor and parallel OSCON.

Note 4 - The trim function (with external resistor) is not functional in the area of $\pm 3.5\%V_{O,nom}$.

ELECTRICAL SPECIFICATIONS

Output Specifications Con't

Table 3. Output Specifications							
Parameter	Condition ¹	Symbol	Min	Typ	Max	Unit	
Dynamic Response ²	Peak Deviation	75%~50%~75% $I_{O,max}$ slew rate=0.1A/ μ s	V_O	-	\pm 130	-	mV
	Settling Time	50%~75%~50% $I_{O,max}$ slew rate=1A/ μ s	T_s	-	200	-	μ s
Turn-on Transient	Rise Time	$V_{IN,DC}=48Vdc, I_O=I_{O,max}$	T_{rise}	-	20	50	ms
	Turn-on Delay Time-1	From $V_{IN,DC}$ reaching Turn-on Voltage	$T_{turn-on}$	-	50	160	ms
	Turn-on Delay Time-2	From ENABLE asserted	$T_{turn-on}$	-	20	50	ms
	Turn-on Overshoot			-	0	250	mV
	Turn-off Undershoot			-	0	250	mV
Switching Frequency		f_{SW}	-	150	-	KHz	
Remote ON/OFF control ³	Off-state Voltage			2.4	-	15	V
	On-state Voltage			-0.3	-	0.8	V
	Current	Logic low				0.5	mA
Pre-bias ⁴		$\%V_O$	0	-	90	%	
Output Over Voltage Protection ⁵			5.8	-	7	V	
Over Temperature Protection ⁶	Baseplate module	T	100	115	125	$^{\circ}C$	
	Open frame module	T	110	120	130	$^{\circ}C$	
Over Temperature Hysteresis of Open frame		T	5	-	-	$^{\circ}C$	
MTBF ⁷	Telcordia, SR332 Method 1 Case 3		-	1.5	-	10^6 hrs	

Note 1 - $T_A=25^{\circ}C$, airflow rate=400 LFM, $V_{IN,DC}=48Vdc$, nominal output voltage unless otherwise noted.

Note 2 - If $T_A<-5^{\circ}C$, the minimum output capacitor need to be doubled, the minimum output capacitor value is 100 μ F. ceramic cap + 360 μ F Oscon.

Note 3 - Logic: negative (default), positive available.

Note 4 - Nominal output voltage @0A, 48Vin.

Note 5 - Hiccup: auto-restart when over voltage condition is removed.

Note 6 - Auto recovery. Over Temperature Protect (OTP) test point: see Figure 17.

Note 7 - 300LFM, $T_A=40^{\circ}C$, $V_{IN,DC}=48Vdc$, nominal output voltage, $I_O=80\%I_{O,max}$.

ELECTRICAL SPECIFICATIONS

Digital Interface Specifications

Table 4. Digital Interface Specifications						
Parameter	Condition ¹	Symbol	Min	Typ	Max	Unit
Input High Voltage (Clock,Data,C2,SMBAAlert)			2.2	-	3.3	V
Input Low Voltage (Clock,Data,C2,SMBAAlert)			0	-	0.8	V
Input High Level Current (Clock,Data,C2,SMBAAlert)			-1	-	1	mA
Output High Voltage (Clock,Data,C2,SMBAAlert)	$I_O=4mA$		2.4	-	-	V
Output Low Voltage (Clock,Data,C2,SMBAAlert)	$I_O=-4mA$		-	-	0.3	V
Output Current Reading Accuracy	$30A < I_O \leq 60A$		-8	1.4	8	%
	$1A < I_O \leq 30A$		-4	-	4	A
Output Current Reading Resolution				0.19	0.5	A
Output Voltage Reading Accuracy			-2	1	2	%
Output Voltage Reading Resolution			-	0.25	0.5	mV
Input Voltage Reading Accuracy			-4	-	4	%
Input Voltage Reading Resolution			-	0.2	1	V
Temperature Reading Accuracy	$T_A > 0^\circ C$		-5	-	5	$^\circ C$
Temperature Reading Resolution	$T_A > 0^\circ C$		-	0.25	1	$^\circ C$

Configurable Control Pins

The module contains two configurable control pins, Trim/C1 and C2, referenced to the module secondary Sig_Gnd. See section Mechanical Outlines for pin locations. The following Table 5 lists the default factory configurations for the functions assigned to these pins. Additional configurations can be accomplished via the PMBus command, what's more, there is a feature description for each function in Table 5.

Table 5. Configurable Control Pins		
Pin Designation/Function		Configuration
Trim/C1	C2	
On/Off	Power Good	Via PMBus
Trim	Power Good	Factory Default
Trim	On/Off	Via PMBus

Note 1 - $T_A=25^\circ C$, airflow rate=400LFM, $V_{IN,DC}=48Vdc$, nominal output voltage unless otherwise noted.

ELECTRICAL SPECIFICATIONS

ADO300-48S05-6L Performance Curves

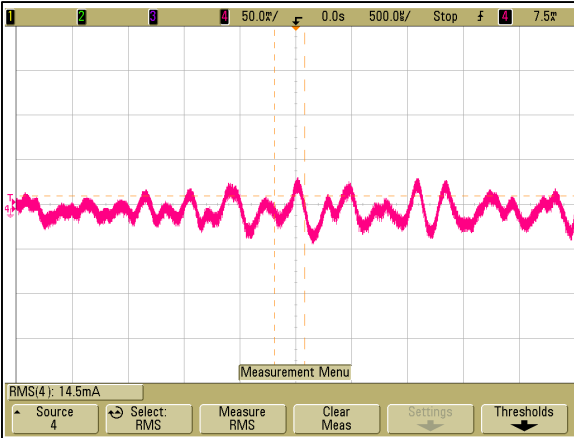

Figure 1: ADO300-48S05 Input Reflected Ripple Current Waveform see figure 13 for test configuration
Ch 2: lin (500uS/div, 50mA/div)



Figure 2: ADO300-48S05 Output Ripple and Noise Measurement see figure 13 for test configuration
Ch 3: Vo (2uS/div, 20mV/div)

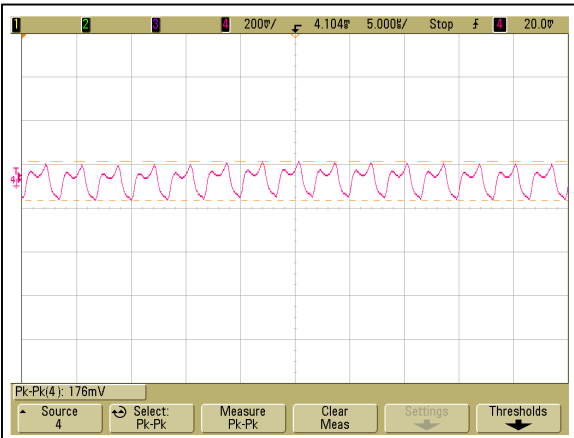

Figure 3: ADO300-48S05 Output Ripple and Noise at normal input with 10uF tantalum / 1uF ceramic capacitor
Ch 4: Vo (5uS/div, 200mV/div)

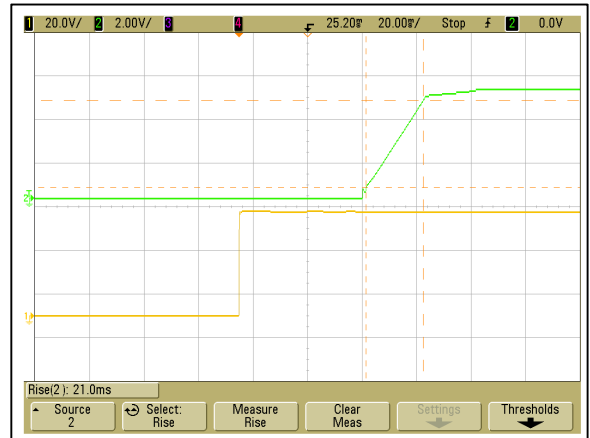

Figure 4: ADO300-48S05 Start up Characteristic by power on (20ms/div) see Figure 21 for test configuration
Ch2: V_O(2V/div) Ch1: VIN (20V/div)

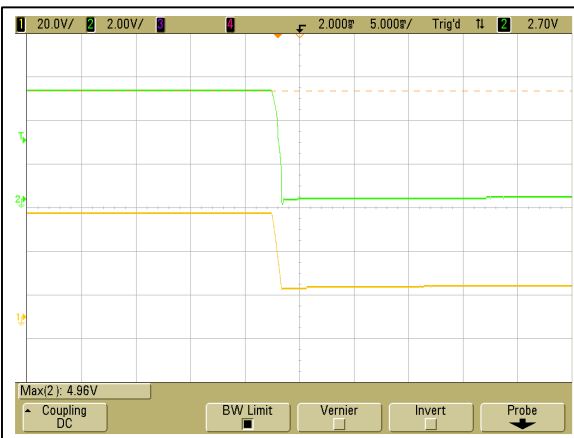

Figure 5: ADO300-48S05 Shut down Characteristic by power off (20mS/div) see figure 21 for test configuration
Ch 2: Vo (2V/div) Ch 1: Vin (20V/div)



Figure 6: ADO300-48S05 Remote ON Waveform (5mS/div) see figure 12 for test configuration
Ch 2: Vo (2V/div) Ch 1: Remote OFF (2V/div)

ELECTRICAL SPECIFICATIONS

ADO300-48S05 Performance Curves

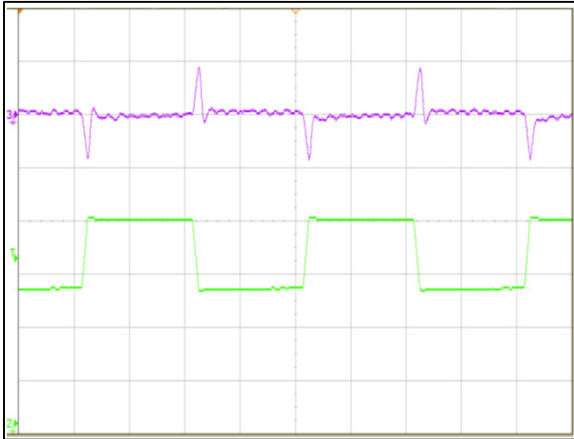

Figure 7. ADO300-48S05 Remote OFF Waveform (5ms/div) see Figure 12 for test configuration
Ch2: V_O (2V/div) Ch1: Remote OFF (2V/div)

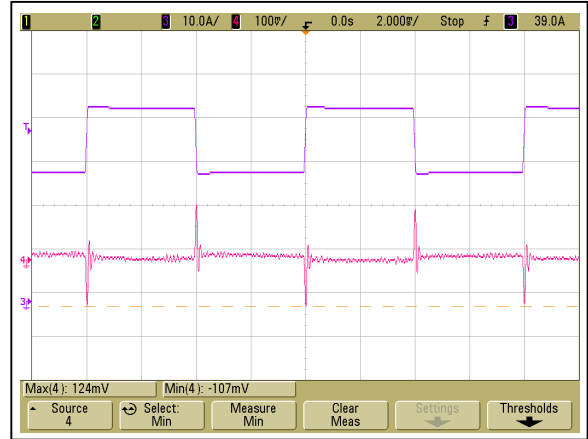

Figure 8. ADO300-48S05 Transient Response 25% load step (50~75~50%) 0.1A/ μ s slew rate (2ms/div) see fig16 for test configuration
Ch4: V_O (50mV/div) Ch3: I_O (20A/div)

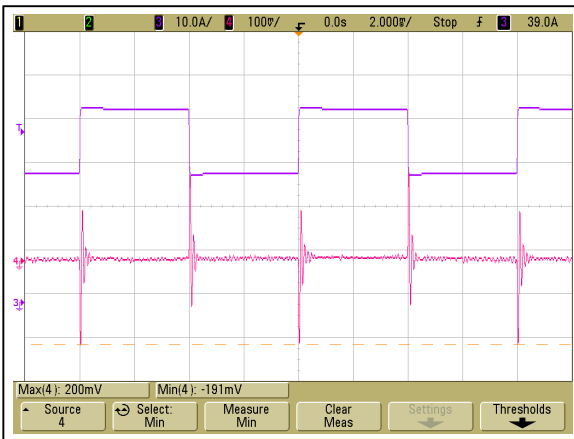

Figure 9. ADO300-48S05 Transient Response 25% load step (50~75~50%) 1A/ μ s slew rate (2ms/div) see fig 16 for test configuration
Ch4: V_O (100mV/div) Ch3: I_O (20A/div)

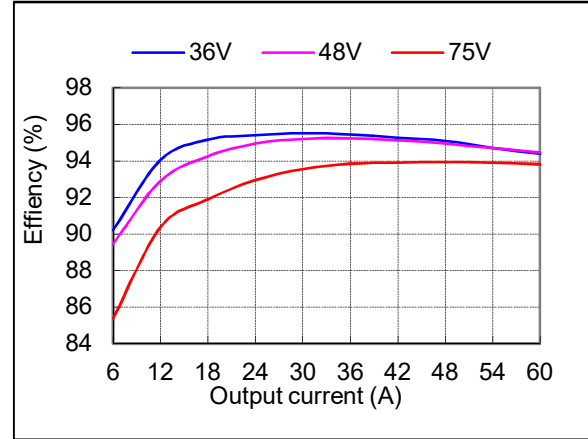

Figure 10. ADO300-48S05 Efficiency Curves @25°C, $V_O=5V$, 800LFM Loading: $I_O=10\%$ increment to 60A

ELECTRICAL SPECIFICATIONS

Protection Function Specifications

Input Fusing

An external fuse is recommended. To meet international safety requirements, a 250V rated fuse should be used. Recommended rating is 15A for the converter.

Note: The fuse is fast blow type.

Over Voltage Protection (OVP)

The output over-voltage protection consists of circuitry that monitors the voltage on the output terminals. When the over-voltage condition is removed, the converter will automatically restart.

Parameter	Min	Nom	Max	Unit
V _O Output Overvoltage	14	/	17	V

Over Current Protection (OCP)

When output current exceeds 110 to 144% of rated current, the converter will work on hiccup mode. When the over-current condition is removed, the converter will automatically restart.

Parameter	Min	Nom	Max	Unit
V _O Output Overcurrent	28	/	48	A

Over Temperature Protection (OTP)

The converter features an over-temperature protection circuit to safeguard against thermal damage. The converter will shutdown when the maximum device reference temperature is exceeded. When the over-temperature condition is removed, the converter will automatically restart.

Open-frame:

Parameter	Min	Nom	Max	Unit
V _O Output Over Temperature	110	/	135	°C

Base-plate:

Parameter	Min	Nom	Max	Unit
V _O Output Over Temperature	110	/	125	°C

MECHANICAL SPECIFICATIONS

Mechanical Outlines - Open Frame Module (unit: mm)

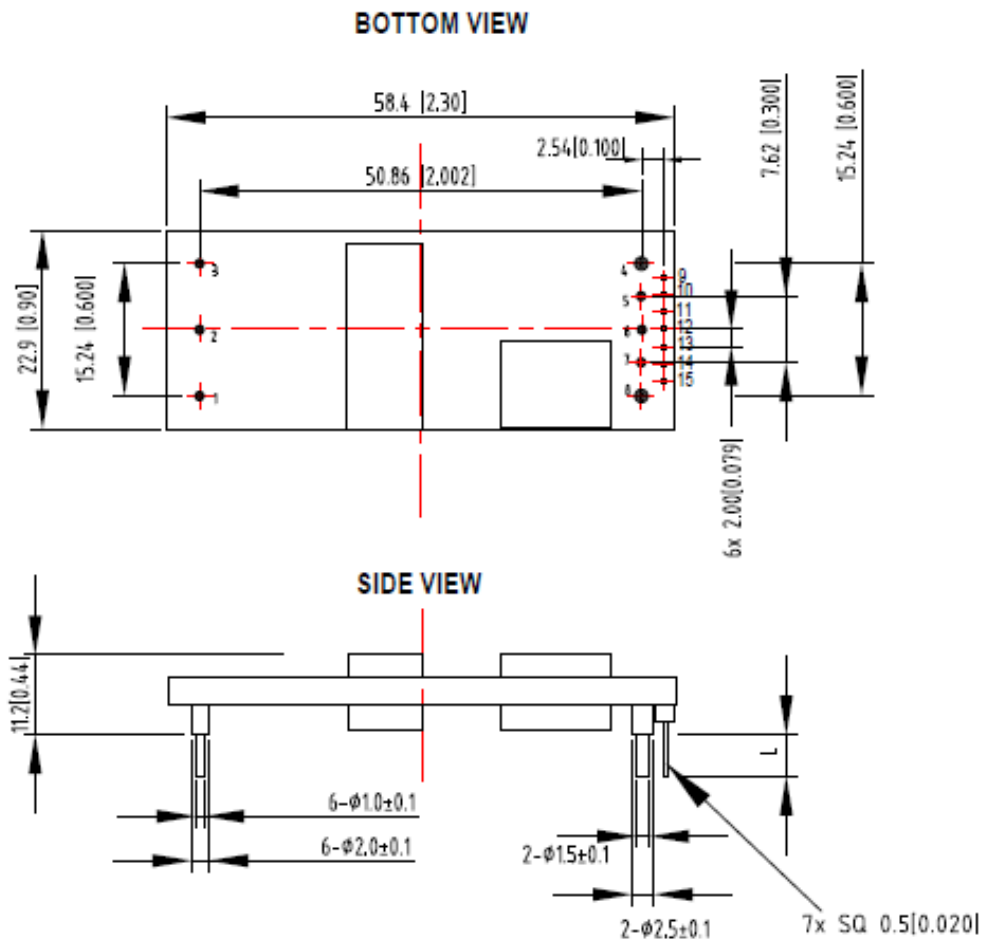

UNIT: mm (inch) L= 3.8±0.25mm

TOLERANCE: X.X mm±0.5mm [X.XX in.± 0.02in.]
X.XX mm±0.25mm[X.XXX in.±0.01in.]

Note 1: Dimensions within the box are critical dimensions.

Note 2: No pin9~15 for ADO300-48S05-6L;
ADO300-48S05-6LI with pin9~15.

MECHANICAL SPECIFICATIONS

Pin Length Option

Device code suffix	L
-4	4.8mm ± 0.25 mm
-6	3.8mm ± 0.25 mm
-8	2.8mm ± 0.25 mm
None	5.8mm ± 0.25 mm

Pin Designations

Pin No	Name	Function	Optional
1	Vin+	Positive input voltage	NA
2	Remote ON/OFF	Remote control	NA
3	Vin-	Negative input voltage	NA
4	Vo-	Negative output voltage	NA
5	-Sense	Remote sense negative	Yes
6	trim/C1	Voltage adjustment	Yes
7	+Sense	Remote sense positive	Yes
8	Vo+	Positive output voltage	NA
9	C2	Digital	Yes
10	Sig_Gnd		
11	Data		
12	SMBAlert		
13	Clock		
14	Addr1		
15	Addr0		

ENVIRONMENTAL SPECIFICATIONS

EMC Immunity

ADO300-48S05 series power supply is designed to meet the following EMC immunity specifications.

Table 6. Environmental Specifications		
Document	Description	Criteria
EN55032, Class B Limits	Conducted and Radiated EMI Limits, DC input port	/
IEC/EN 61000-4-2, Level 3	Electromagnetic Compatibility (EMC) - Testing and measurement techniques: Electrostatic Discharge (ESD) immunity test	B
IEC/EN 61000-4-4, Level3	Electromagnetic Compatibility (EMC) - Testing and measurement techniques: Electrical Fast Transient (EFT). DC input port.	B
IEC/EN 61000-4-5	Electromagnetic Compatibility (EMC) - Testing and measurement techniques: Immunity to Surges (Surges) - 600V common mode and 600V differential mode for DC input port	B
IEC/EN 61000-4-6, Level 2	Electromagnetic Compatibility (EMC) - Testing and measurement techniques: Continuous Conducted Interference. DC input port	A
EN61000-4-29	Electromagnetic Compatibility (EMC) - Testing and measurement techniques: Voltage Dips and Short Interruptions and Voltage Variations (Dips). DC input port	B

Criterion A: Normal performance during and after test.

Criterion B: For EFT and Surges, low-voltage protection or reset is not allowed. Temporary output voltage fluctuation ceases after disturbances ceases, and from which the EUT recovers its normal performance automatically. For Dips and ESD, output voltage fluctuation or reset is allowed during the test, but recovers to its normal performance automatically after the disturbance ceases.

Criterion C: Temporary loss of output, the correction of which requires operator intervention.

Criterion D: Loss of output which is not recoverable, owing to damage to hardware.

Recommend EMC Filter Configuration

More details refer to section EMC Test Conditions in Application Notes.

ENVIRONMENTAL SPECIFICATIONS

Safety Certifications

The ADO300-48S05 power supply is intended for inclusion in other equipment and the installer must ensure that it is in compliance with all the requirements of the end application. This product is only for inclusion by professional installers within other equipment and must not be operated as a stand alone product

Table 7. Safety Certifications for ADO300-48S05 series module

Standard	Agency	Description
UL 62368-1:2014: CAN/CSA C22.2 No. 62368-1:2014	UL/CUL	US and Canada Requirements
EN 62368-1:2014/A11:2017	TUV-SUD	European Requirements
EN 62368-1:2014/A11:2017	CE	CE Marking

Qualification Testing

Parameter	Unit (pcs)	Test Condition
Halt test	2	$T_{A,min} -20^{\circ}\text{C}$ to $T_{A,max} +25^{\circ}\text{C}$, 5°C step, $V_{IN,DC}=V_{IN,min}$ to $V_{IN,max}$ $I_O=I_{O,min}$ to $I_{O,max}$
Vibration	2	Frequency range: 5Hz ~ 20Hz, 20Hz ~ 200Hz A.S.D: $1.0\text{m}^2/\text{s}^3$, -3db/oct Axes of vibration: X/Y/Z Time: 30min/axes
Mechanical Shock	2	Type: half sine Acceleration: 30g Duration: 6ms Directions:6 Number of shock: 3times/face
Thermal Shock	3	High Temp: 125°C Low Temp: -55°C Temp Dwell Time:30min Temp change rate: $20^{\circ}\text{C}/\text{min}$ Cycles:20cycles
Thermal Cycling	3	-40°C to 85°C , temperature change rate: $1^{\circ}\text{C}/\text{min}$, cycles: 2cycles
Humidity	3	40°C , 95%RH, 48hrs
Solder ability	15	IPC J-STD-002C-2007

ENVIRONMENTAL SPECIFICATIONS

Operating Temperature

The ADO300-48S05 power supply will start and operate within stated specifications at an ambient temperature from -40°C to 85°C under all load conditions. The storage temperature is -55°C to 125°C. Over Temperature Protect (OTP) test point is shown in Figure 11, it is on the left of Figure11 that is on the surface of temperature sensor for open frame module, and it is on the right of Figure11 that is in the center of baseplate for module with baseplate.

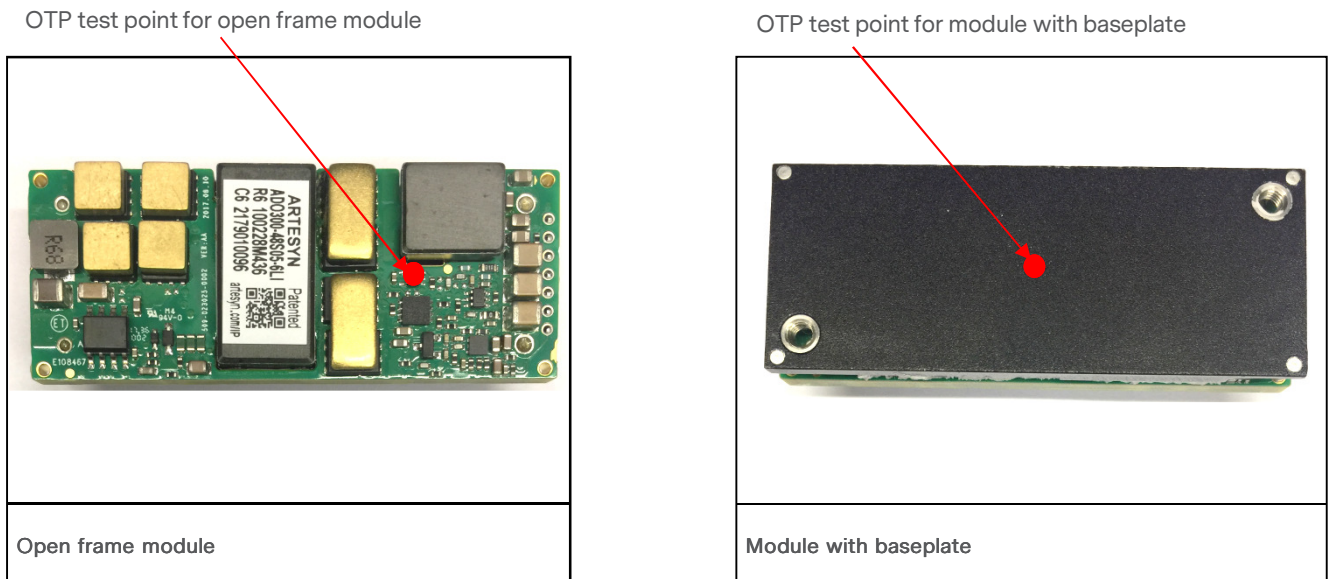

Figure 11. Over Temperature Protect test point

Thermal Considerations – Open-frame module

ADO300-48S05 is designed to operate in different thermal environments and sufficient cooling must be provided. Thermal image has been taken by a RF camera at $T_A=25^{\circ}\text{C}$, $V_{IN,DC}=48\text{Vdc}$, $I_O=I_{O,max}$, nominal output voltage, as indicated in Figure 12.

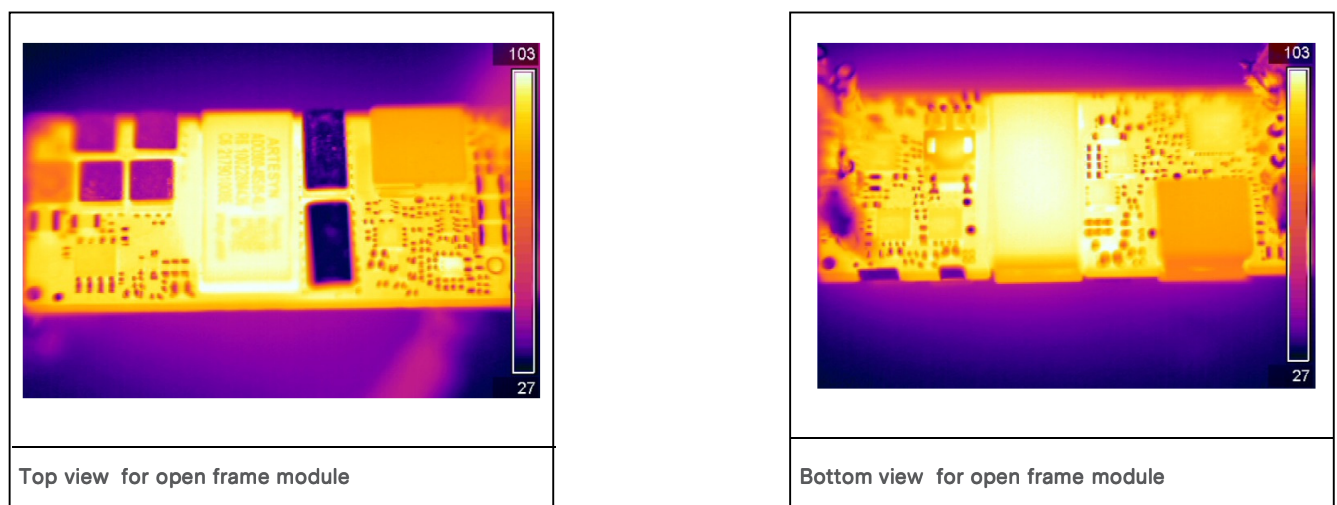

Figure 12. Thermal image, @ $T_A=25^{\circ}\text{C}$, $V_{IN,DC}=48\text{Vdc}$, $I_O=I_{O,max}$, nominal output voltage

ENVIRONMENTAL SPECIFICATIONS

Thermal Considerations – Open frame module Con't

Proper cooling can be verified by measuring the temperature at these test points as shown in Figure 13. The number of test points may vary with different thermal design and topology. The temperature above the limit values in Table 8 are not allowed. For a typical application, There is the thermal derating data of output current vs. ambient air temperature at different air velocity @48Vin for open frame module.

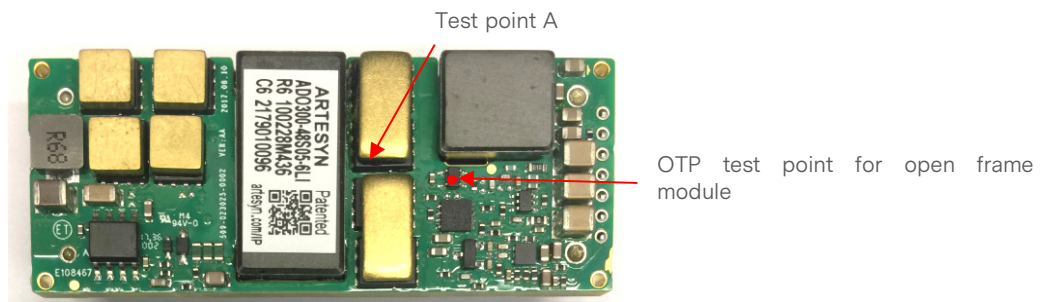

Figure 13 Temperature test point for open frame module

Table 8. Temperature limit of the test point	
Test Point	Temperature Limit (°C)
Test point A	129
OTP test point for open frame module	115

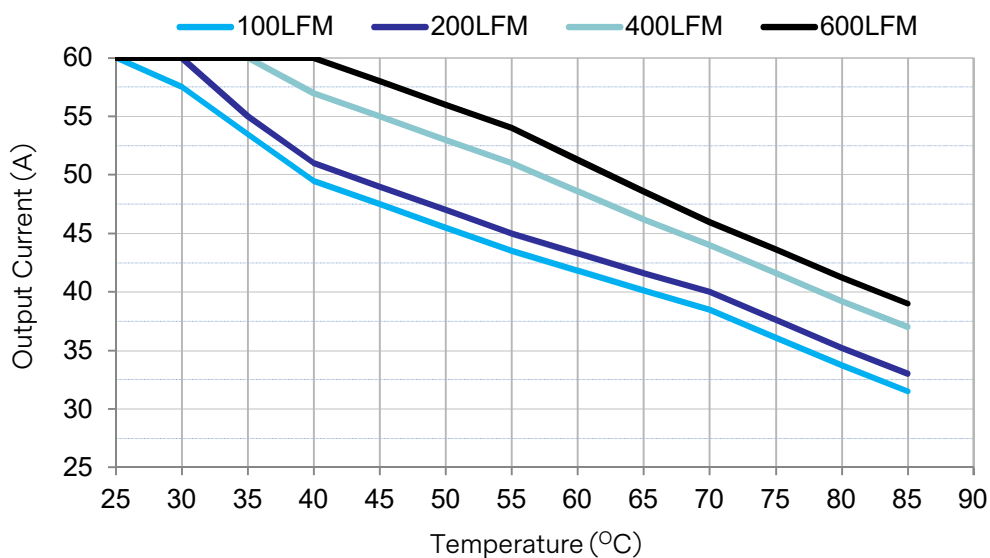

Figure 14. Thermal derating data for open frame module @48Vin, airflow from Vin- to Vin+

ENVIRONMENTAL SPECIFICATIONS

Thermal Considerations – Baseplate Module

ADO300-48S05B can both operate in two different modes.

Mode 1: The converter is designed to operate in different thermal environments and sufficient cooling must be provided. Proper cooling can be verified by measuring the temperature at the test points as shown in figure 15. The temperature at this point should not exceed the max values in the table 9. The temperature above the limit values in Table 9 are not allowed. For a typical application, There is the thermal derating data of output current vs. ambient air temperature at different air velocity @48Vin for baseplate module in Figure 16.

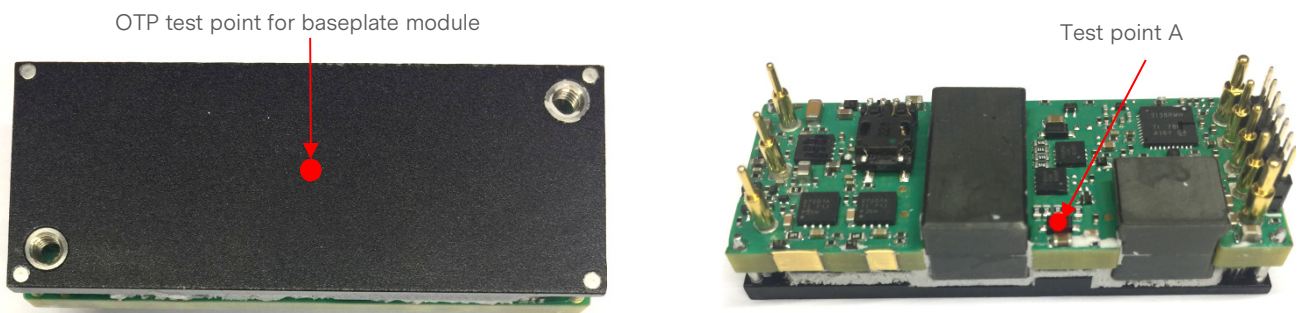

Figure 15 Temperature test point for Baseplate module

Table 9. Temperature limit of the test point	
Test Point	Temperature Limit (°C)
Test point A	124
OTP test point for baseplate module	109

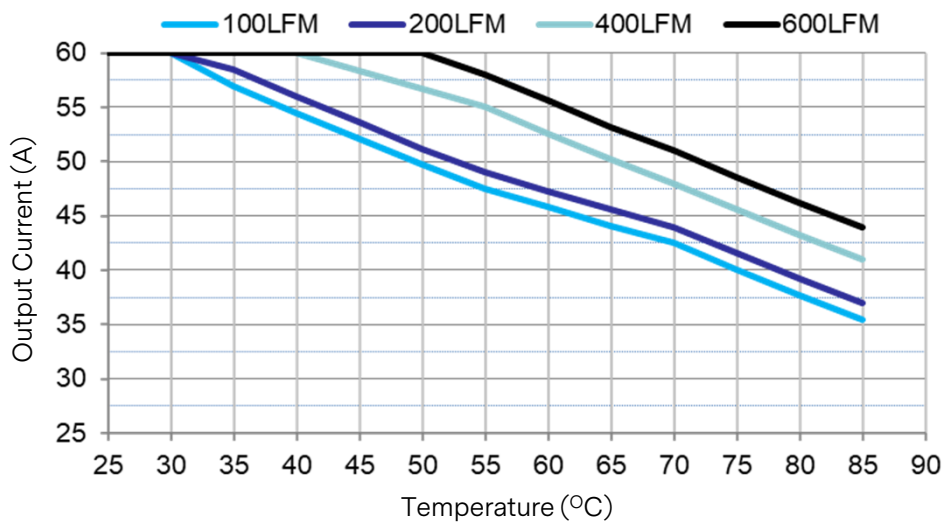

Figure 16. Thermal derating data for Baseplate module @48Vin, airflow from Vin- to Vin+

ENVIRONMENTAL SPECIFICATIONS

Figure 17 shows the derating of output current vs. ambient air temperature at different air velocity @48V input with a 0.5" heat sink. The heat sink specification is shown in Figure 18.

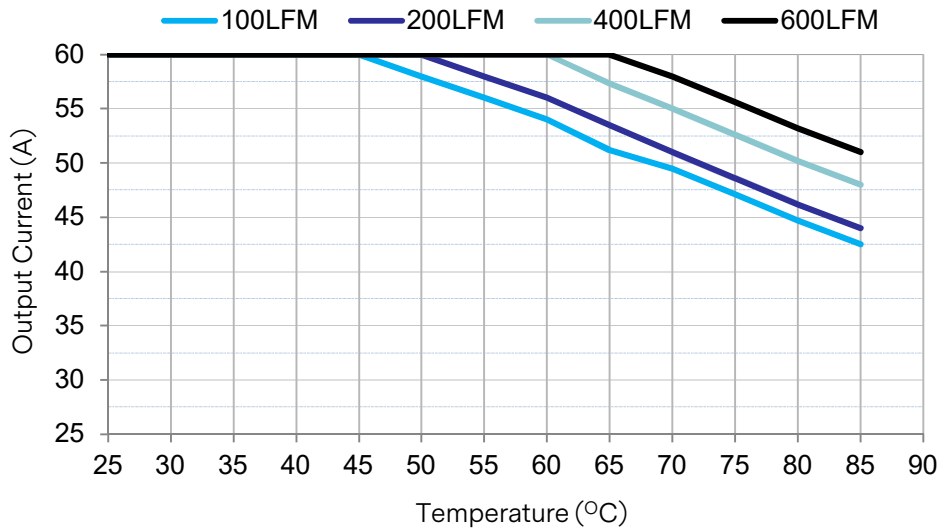

Figure 17. Thermal derating data for baseplate module with 0.5" heat sink @48Vin, airflow from Vin- to Vin+

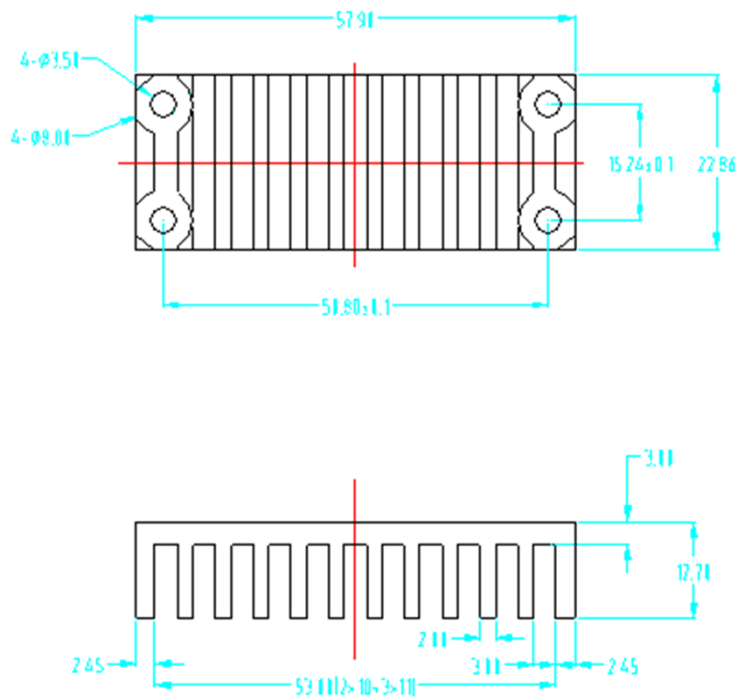

Figure 18. 0.5" heat sink mechanical diagram

ENVIRONMENTAL SPECIFICATIONS

Mode 2: The converter can operate in a enclosed environment without forced air convection. Cooling of the converter is achieved mainly by conduction from the baseplate to a heat sink. Hot spot temperature measured point is shown in figure 19. The temperature at this point should not exceed the max values in the table 10. The temperature above the limit values Table 10 are not allowed. For a typical application, figure 19 shows the derating of output current vs. baseplate temperature, provided ambient temperature is kept below the max values 85°C.

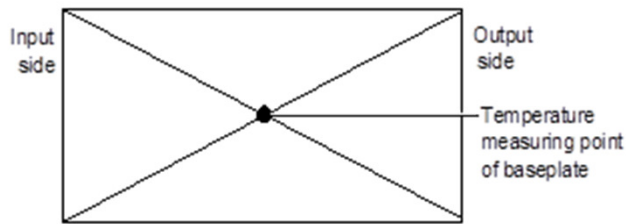

Figure 19. Temperature test point on base plate

Table 10. Temperature limit of the test point	
Test Point	Temperature Limit (C)
Test point A	124

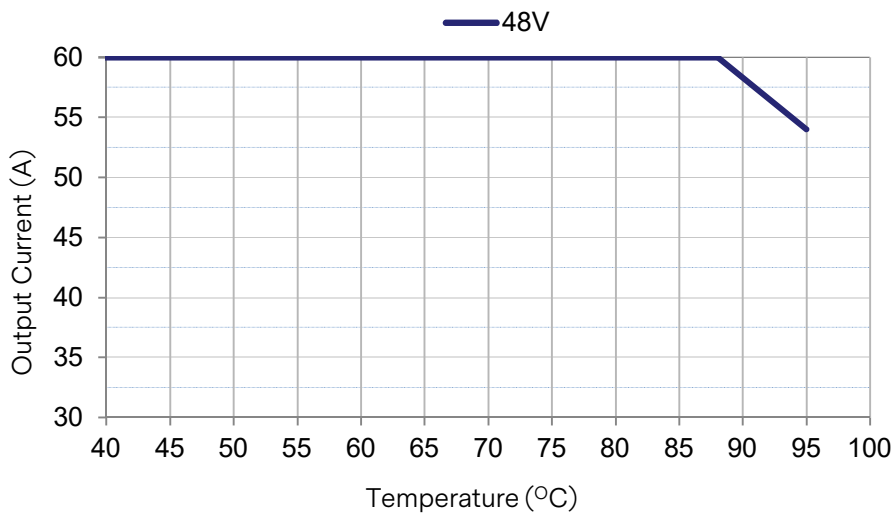

Figure 20. The derating of output current vs. baseplate temperature for baseplate module in a enclosed environment without forced air convection

APPLICATION NOTES

Typical Application

Below is the typical application of the ADO300-48S05 series power supply.

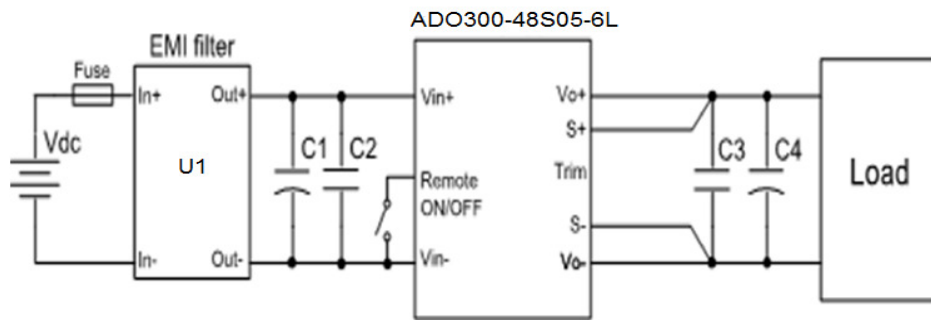

Figure 21 Typical application

Fuse: external fast blow fuse with a rating of 10A/250Vac. The recommended fuse model is 0314015.P from Karwin Tech limited.

EMI filter: refer to U1 in Figure 25.

C1~C4: see Figure 25.

APPLICATION NOTES

Configurable Control Pins

The module contains two configurable control pins, Trim /C1 and C2, referenced to the module secondary SIG_GND. See Mechanical Views for pin locations. The following table list the default factory configurations for the functions assigned to these pins. Additional configurations can be accomplished via the PMBus™ command. Following the table, there is a feature description for each function.

Pin Designation/Function		Configuration
Trim/C1	C2	
Trim	Power Good	Factory Default
On/Off	Power Good	Via PMBus™
Trim	On/Off	Via PMBus™

Remote ON/OFF

Standard negative remote ON/OFF logic is available in ADO300-48S05(B)-6L(I). The logic is CMOS and TTL compatible.

Remote ON/OFF (ENABLE) can be controlled by an external switch between the on/off terminal and the Vin- terminal. The switch can be an open collector or open drain.

The voltage between pin Remote ON/OFF and pin Vin- must not exceed the range listed in Table 3 to ensure proper operation. The external Remote ON/OFF circuit is highly recommended as shown in Figure 22.

For the negative logic, if the remote ON/OFF (ENABLE) feature is not used, please maintain the ENABLE pin to Vin-.

Secondary Remote On/Off

The module contains an additional secondary remote on/off control, via either the Trim/C1 or C2 pin, reference to the output Sig_Gnd pin. And such pin can be reconfigured as secondary remote on/off pin by the PMBus interface including either negative or positive logic. Negative logic turns the module on during a logic low and off during a logic high. Positive logic turns the module on during a logic high and off during a logic low. The secondary remote on/off can be controlled by an external switch between Trim/C1 or C2 and output Sig_Gnd pin. The switch can be an open collector or open drain, more details refer to Figure 22

If not using the secondary remote on/off control, the pin may be left N/C

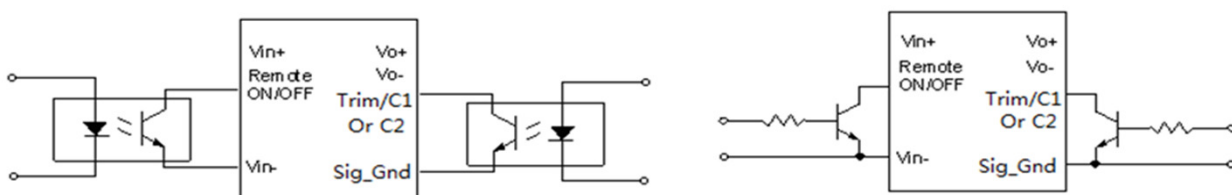

Isolated remote ON/OFF circuit

Non-isolated remote ON/OFF circuit

Figure 22 Typical application

APPLICATION NOTES

Parallel and Droop Current Sharing

The module is capable of operating in parallel, and realizing current sharing by droop current sharing method. There is about 150mV output voltage droop from 0A to full output Load, and there is no current sharing pin. By connecting the Vin pin and the Vo pin of the parallel module together, the current sharing can be realized automatically.

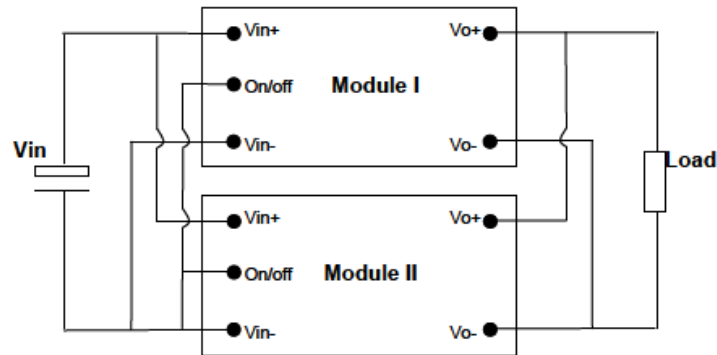

Figure 23 Parallel and droop current sharing configuration for no redundancy requirement system

If system has no redundancy requirement, the module can be parallel directly for higher power without adding external oring-fet; whereas, if the redundancy function is required, the external oring-fet should be added.

For a normal parallel operation the following precautions must be observed:

1. The current sharing accuracy equation is:

$$X\% = \left| I_o - \left(I_{total} / N \right) \right| / I_{rated}$$

Where, I_o is the output current of per module; I_{total} is the total load current; N is parallel module numbers; I_{rated} is the rated full load current of per module.

2. To ensure a better steady current sharing accuracy, below design guideline should be followed:

- The inputs of the converters must be connected to the same voltage source; and the PCB trace resistance from Input voltage source to V_{in+} and V_{in-} of each converter should be equalized as much as possible.
- The PCB trace resistance from each converter's output to the load should be equalized as much as possible.
- For accurate current sharing accuracy test, the module should be soldered in order to avoid the unbalance of the touch resistance between the modules to the test board.

3. To ensure the parallel module can start up monotonically without triggering the OCP circuit, below design guideline should be followed:

- Before all of the parallel modules finished start up and PG signal asserts, the total load current should be lower than the rated current of 1 module.
- The ON/OFF pin of the converters should be connected together to keep the parallel modules start up at the same time.
- The under voltage lockout point will slightly vary from unit to unit. The dv/dt of the rising edge of the input source voltage must be greater than 1V/ms to ensure that the parallel module start up at the same time.

4. If fault tolerance is desired in parallel applications, output ORing devices should be used to prevent a single module failure from collapsing the load bus.

APPLICATION NOTES

Power Good - PG

The module provides a Power Good ((PG), C2 Pin) feature, to indicate that the output voltage is within the normal output voltage range of the power module. The PG signal will be de-asserted to a low state if any condition such as over temperature, over current, Input Under Voltage Lockout (UVLO), output voltage protect (OVP), startup with diode emulation mode or loss of regulation occurs that would result in the output voltage going below the normal voltage range value.

The Power Good signal, provided on pin C2, is implemented with an open-drain node, pulled up via a 10k Ω resistor to 3.3V internally. For Positive Logic PG (default), the PG signal is high level, when PG is asserted.

If not using the Power Good feature, the pin may be left N/C.

Remote Sense

If the load is far from the unit, connect S+ and S- to the terminal of the load respectively to compensate the voltage drop on the transmission line, When using remote sense and trim, the output current should be decreased accordingly so as not to exceed the maximum output power. If the sense compensate function is not necessary, connect S+ to Vo+ and S- to Vo- directly.

Input Ripple & Output Ripple & Noise Test Configuration

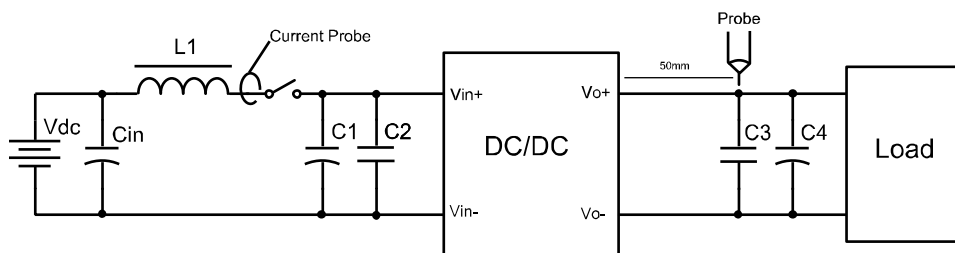

Figure 24 Input ripple & inrush current output ripple & noise test configuration

Vdc: DC power supply

L1: 12 μ H

Cin: 220 μ F/100V typical.

C1~C4: See Figure 16.

Note - Using a coaxial cable with series 50 Ω resistor and 0.68 μ F ceramic capacitor or a ground ring of probe to test output ripple & noise is recommended.

APPLICATION NOTES

EMC Test Conditions

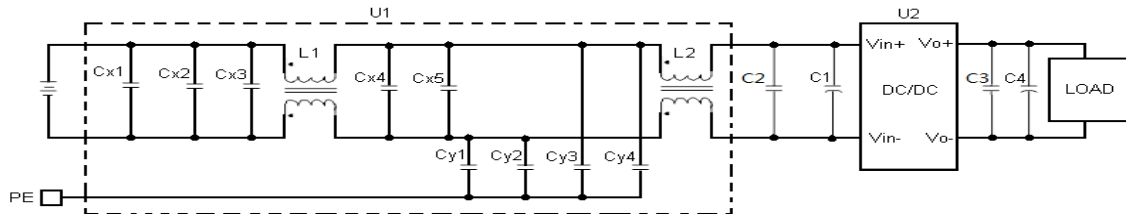

Figure 25 Typical application

C1: 330 μ F/100V electrolytic capacitor, P/N: UPM2A331MPD (Nichicon) or equivalent caps

C2: 0.1 μ F/100V/X7R capacitor

C3: 100 μ F/10V/X7S ceramic capacitor

C4: 1000 μ F/16V electrolytic capacitor, P/N: OSCON or POSCAP

U1: Input EMC filter

U2: Module to test, ADO300-48S05

CX1, CX2, CX3, CX4, CX5: 1 μ F/100V/X7R capacitor

Cy1, Cy2, Cy3, Cy4: 0.88 μ F/630V/X7R, Y capacitor

L1, L2: 473 μ H, common mode inductor

Fuse: External fast blow fuse with a rating of 15A/250Vac. The recommended fuse model is 0314015.P from Karwin Tech limited.

ELECTRICAL SPECIFICATIONS

Trim Characteristics

To increase or decrease the output voltage set point, an external resistor is connected between the trim pin and either the Vo+ or Vo-. The trim pin should be left open if this feature is not used. Below Trim equation is only adapt to the module without droop current sharing option code. For the module with droop current sharing option code, please contact Artesyn’s technical support team.

Connecting an external resistor between Trim pin and Vo- pin will decrease the output voltage, while connection it between Trim and Vo+ will increase the output voltage, more details refer to Figure 25. The following equations determine the external resistance to obtain the trimmed output voltage. When trimming up, the output current should be decreased accordingly so as not to exceed the maximum output power.

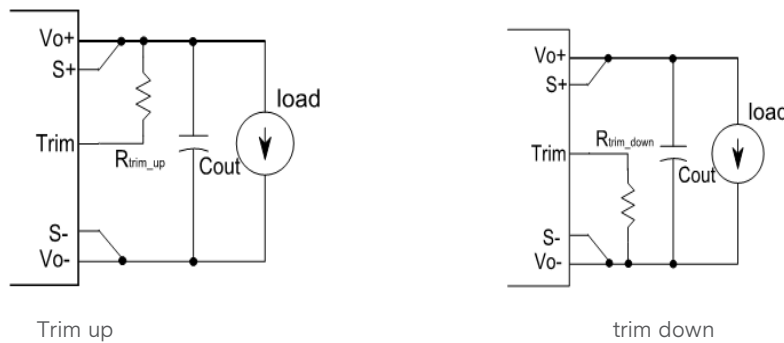

Figure 26. Trim External Diagram

$$R_{adj_down} = \left(\frac{511}{\Delta} - 10.22 \right) k\Omega$$

$$R_{trim_up} = \left(\frac{5.11 \times V_{norm} \times (100\% + \Delta)}{1.225 \times \Delta\%} - \frac{511}{\Delta\%} - 10.22 \right) k\Omega$$

Δ : Output rate against normal output voltage.

$$\Delta = \left| \frac{100 \times (v_0 - v_{norm})}{v_{norm}} \right|$$

V_{norm} : Nominal output voltage

For example, to get desired output voltage, 5.7V, so V_o equates 5.7V.

$$\Delta = \frac{100 \times (v_0 - v_{norm})}{v_{norm}} = \frac{100 \times (5.7 - 5)}{5} = 14$$

$$R_{trim_up} = \frac{5.11 \times 5 \times (100 + \Delta)}{1.225 \times \Delta} - \frac{511}{\Delta} - 10.22 = \frac{5.11 \times 5 \times (100 + 14)}{1.225 \times 14} - 511 / 14 - 10.22 = 123.12 (k\Omega)$$

So, the external resistor is 123.12K Ω . The output voltage can also be trimmed by potential applied at the Trim pin.

$$V_o = (V_{trim} + 1.225) \times 2.0408$$

Where V_{trim} is the potential applied at the Trim pin, and V_o is the desired output voltage.

When trimming up the output voltage, the minimum input voltage should be increased as shown in figure 15.

APPLICATION NOTES

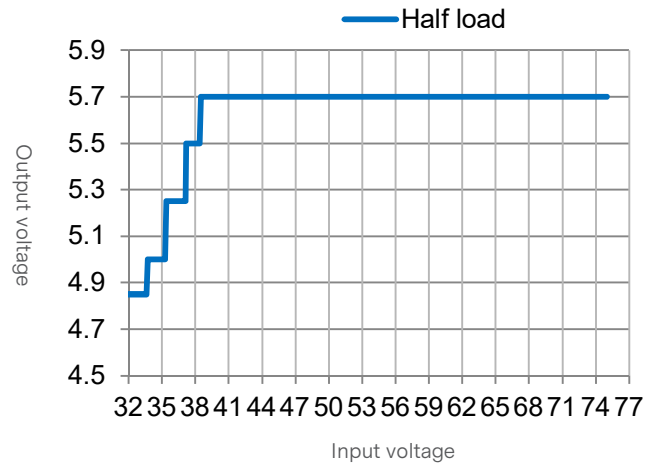

Figure 26. Trimming up the output voltage

When trimming up the output voltage, the minimum input voltage should be increased as shown in figure 26

PMBus™ SPECIFICATIONS

PMBus™ communication

The module has a digital PMBus interface to allow the module to be monitored, controlled and configured by the system. The module supports 4 PMBus signal lines, Data, Clock, SMBAlert (optional), Control (C2 pin, optional), and 2 Address lines Addr0 and Addr1. More detail PMBus information can be found in the PMBus Power Management Protocol Specification, Part I and part II, revision 1.2; which is shown in <http://pmbus.org>. Both 100kHz and 400kHz bus speeds are supported by the module. Connection for the PMBus interface should be following the High Power DC specifications given in section 3.1.3 in the SMBus specification V2.0 or the Low Power DC specifications in section 3.1.2. The complete SMBus specification is shown in <http://smbus.org>.

The module supports the Packet Error Checking (PEC) protocol. It can check the PEC byte provided by the PMBus master, and include a PEC byte in all message responses to the master.

The module contains a data flash used to store configuration settings, which will not be programmed into the device data flash automatically. The STORE_DEFAULT_ALL command must be used to commit the current settings are transfer from RAM to data flash as device defaults.

PMBus™ Addressing

The module has flexible PMBus addressing capability. When connect different resistor from Addr0 and Addr1 pin to Sig_Gnd pin, 64 possible PMBus addresses can be acquired. The PMBus address is set in the form of two octal (0 to 7) address, with each pin setting one address. Then combine together to form the decimal address as shown in below.

Decimal Address=16 X Addr1 + Addr0

Corresponded to each octal address, the requested resistor values are shown in below table. (1% tolerance resistors are recommended)

Octal Addr0/Addr1	Resistor Value (KΩ)
0	24.9
1	49.9
2	75
3	100
4	124
5	150
6	174
7	200

There is two 510KΩ resistor built in the Addr0 and Addr1 pins to Sig_Gnd already, refer below diagram. So in order to obtain the resistance value, you must configure a resistor in parallel with the 510KΩ resistor. If the resistor combination is configured as an invalid decimal address (0 through 12, 40, 44, 45, and 55), the PMBus address is 58, and if Addr1 pin or Addr0 pin is floating, the PMBus address is 88.

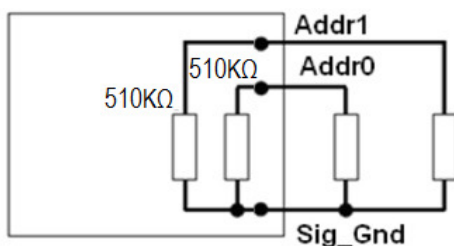

PMBus™ SPECIFICATIONS

For better understand, here is an example showing how to calculate a PMBus address per above description.

If user add two 212KΩ and 212KΩ at the point of Addr0/Addr1 to Sig_Gnd as showing in below.

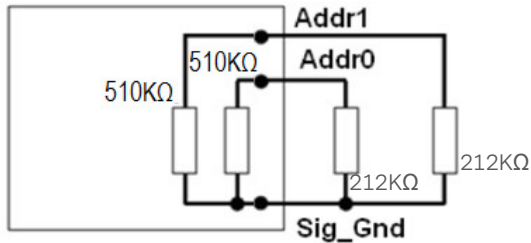

The resistor value from Addr0 to Sig_Gnd will be $510 \times 212 / (510 + 212) = 150 \text{K}\Omega$

The resistor value from Addr1 to Sig_Gnd will be $510 \times 212 / (510 + 212) = 150 \text{K}\Omega$

Per below table, the octal addr0 = 5, the octal addr1 = 5.

Octal Address0/Address1	Resistor Value (KΩ)
0	24.9
1	49.9
2	75
3	100
4	124
5	150
6	174
7	200

So the decimal address = $16 \times \text{Addr1} + \text{Addr0} = 85 \text{d} (0101\ 0101 \text{b})$

Then the 7bit PMBus address = $101\ 0101 \text{b} = 55 \text{h}$

The 8bit PMBus address = $1010\ 1010 \text{b} = \text{AAh}$

PMBus™ SPECIFICATIONS

PMBus™ Data Format

The module receives and report date in LINEAR format. The Exponent of the data words is fixed at a reasonable value for the command; altering the exponent is not supported. DIRECT format is not supported by the module.

For commands that set or report any voltage thresholds related to the output voltage, the module supports the linear data format consisting of a two byte value with a 16-bit, unsigned mantissa, and a fixed exponent of -9. The format of the two data bytes is shown below:

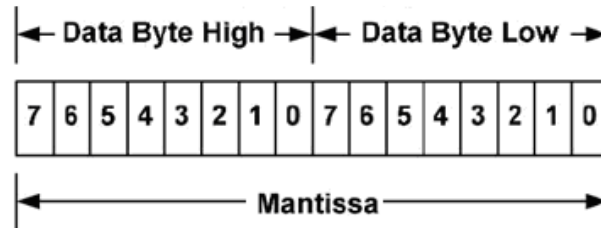

The equation can be written as:

$$V_o = \text{Mantissa} \times 2^{-9}$$

For example, considering set V_o to 3.3V by VOUT_COMMAND, the read/write data can be calculated refer to below process:

1. Mantissa = $V_o / 2^{-9} = 3.3 / 2^{-9} = 1689.6$;
2. Converter the calculated Mantissa to hexadecimal 0x699.

For commands that set or report all other thresholds, including input voltages, output current, temperature, time and frequency, the supported linear data format is a two byte value with: an 11 bit, two's complement mantissa, and a 5 bit, two's complement exponent (scaling factor). The format of the two data bytes is shown as in below.

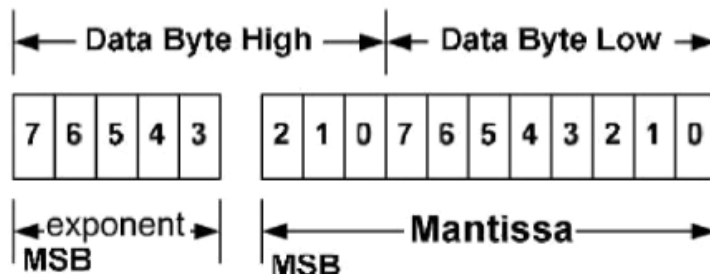

The equation can be written as:

$$\text{Value} = \text{Mantissa} \times 2^{\text{exponent}}$$

For example, considering set the turn on threshold of input under voltage lockout to 33V by VIN_ON command; the read/write data can be calculated refer to below process:

1. Get the exponent of VIN_ON, 0; whose binary is 00000
2. Mantissa = $V_{IN,ON} / 20 = 33 / 20 = 33$;
3. Converter the calculated Mantissa to hexadecimal 21, then converter to binary 00000100001;
4. Combine the exponent and the mantissa, 00000 and 0000000000100001;
5. Converter binary 0000000000100001 to hexadecimal 0021.

The detail exponent and resolution of main parameter is to be decided later.

PMBus™ SPECIFICATIONS

PMBus™ Enabled On/Off

The module can also be turned on and off via the PMBus interface. The OPERATION command is used to actually turn the module on and off via the PMBus. Bit [7] in the OPERATION command data byte enables the module, with the following functions:

- 0: Output is disabled
- 1: Output is enabled

PMBus™ Adjustable Input Under voltage Lockout

The module allows adjustment of the input under voltage lockout and hysteresis. The command VIN_ON allows setting the input voltage turn on threshold, while the VIN_OFF command sets the input voltage turn off threshold. For both the VIN_ON and VIN_OFF commands, possible values range from 30.000 to 36.000V in 0.1V steps. VIN_ON must be 1.5V greater than VIN_OFF. The data associated with VIN_ON and VIN_OFF can be stored to non-volatile memory using the STORE_DEFAULT_ALL command.

PMBus™ Adjustable Soft Start Delay and Rise Time

The soft start delay and rise time can be adjusted in the module via PMBus. The TON_DELAY command sets the delay time in ms, and allows choosing delay times between 30ms and 160ms, with resolution of 0.1ms. The TON_RISE command sets the rise time in ms, and allows choosing soft start times between 10ms and 50ms, with resolution of 0.1ms. When setting TON_RISE, make sure that the charging current for output capacitors can be delivered by the module in addition to any load current to avoid nuisance tripping of the over current protection circuitry during startup. The data associated with TON_RISE and TON_DELAY can be stored to non-volatile memory using the STORE_DEFAULT_ALL command.

Output Voltage Adjustment Using the PMBus™

The ADO300-48S05-6LI module output voltage set point is adjusted using the VOUT_COMMAND. The output voltage setting uses the Linear data format, with the 16 bits of the VOUT_COMMAND formatted as an unsigned mantissa, and a fixed exponent of -9 (decimal) (read from VOUT_MODE).

$$VOUT = \text{Mantissa} \times 2^{-9}$$

The range limits for VOUT_COMMAND are 4V to 5.7V, and the resolution is 1.171mV. The data associated with VOUT_COMMAND can be stored to non-volatile memory using the STORE_DEFAULT_ALL command.

Output Voltage Margining Using the PMBus™

The ADO300-48S05-6LI module can also have its output voltage margined via PMBus commands. The command VOUT_MARGIN_HIGH sets the margin high voltage, while the command VOUT_MARGIN_LOW sets the margin low voltage. Both the VOUT_MARGIN_HIGH and VOUT_MARGIN_LOW commands use the “Linear” mode with the exponent fixed at -9 (decimal). The data associated with VOUT_MARGIN_HIGH and VOUT_MARGIN_LOW can be stored to non-volatile memory using the STORE_DEFAULT_ALL command. The module is commanded to go to the margined high or low voltages using the OPERATION command. Bits [5:2] are used to enable margining as follows:

- 00XX: Margin Off
- 0110: Margin Low (Act on Fault)
- 1010: Margin High (Act on Fault)

Measuring Input Voltage Using the PMBus™

The module can provide input voltage information using the READ_VIN command. During module manufacture, offset and gain correction values are written into the non-volatile memory of the module to null errors in the tolerance and A/D conversion of Vin. The command MFR_VIN_READ_CAL_GAIN can be used to read the gain correction - two bytes consisting of an unsigned 16 bit number. The corrected input voltage reading is then given by:

$$V_{in}(\text{read}) = [(V_{in}(\text{ad}) + MFR_VIN_READ_CAL_OFFSET) \times MFR_VIN_READ_CAL_GAIN / 100]$$

PMBus™ SPECIFICATIONS

Measuring Output Current Using the PMBus™

The module measures output current by using the output filter inductor winding resistance as a current sense element. The module can provide output current information using the READ_IOUT command. The command returns two bytes of data in the linear format. The upper five bits [7:3] of the high data byte form the two's complement representation of the exponent. The remaining 11 bits are used for two's complement representation of the mantissa, with the 11th bit fixed at zero since only positive numbers are valid.

During module manufacture, offset and gain correction values are written into the non-volatile memory of the module to null errors in the tolerance and A/D conversion of IOUT. The command MFR_IOUT_CAL_OFFSET can be used to read the offset - two bytes consisting of a five-bit exponent (fixed at -4) and an 11-bit mantissa in two's complement format. The resolution is 0.19A. The command MFR_IOUT_CAL_GAIN can be used to read the gain correction - two bytes consisting of an unsigned 16 bit number. The resolution of this correction factor 0.000122.

The READ_IOUT command provides module average output current information. This command only supports positive current sourced from the module. If the converter is sinking current a reading of 0 is provided.

$$I_{out}(read) = [(I_{out}(ad) - MFR_IOUT_CAL_OFFSET)] \times 1000 / MFR_IOUT_CAL_GAIN$$

Note that the current reading provided by the module is measured in the room temperature.

Measuring the Temperature using the PMBus™

The module can provide temperature information using the READ_TEMPERATURE_1 command. The command returns two bytes of data in the linear format. The upper five bits [7:3] of the high data byte form the two's complement representation of the exponent. The remaining 11 bits are used for two's complement representation of the mantissa.

Note that the module's temperature sensor is located close to the module hot spot TH1 (see Thermal Considerations) and is subjected to temperatures higher than the ambient air temperature near the module. The temperature reading will be highly influenced by module load and airflow conditions.

Reading the Status of the Module using the PMBus™

The module supports a number of status information commands implemented in PMBus. However, not all features are supported in these commands. An X in the FLAG cell indicates the bit is not supported

PMBus™ SPECIFICATIONS

STATUS_WORD: Returns two bytes of information with a summary of the module's fault/warning conditions.

High Byte:

Bit Position	Flag	Default Value
15	VOUT fault	0
14	IOUT fault or warning	0
13	Input Voltage fault	0
12	X	0
11	POWER_GOOD#(is negated)	0
10	X	0
9	X	0
8	X	0

Low Byte:

Bit Position	Flag	Default Value
7	X	0
6	OFF	0
5	VOUT Over voltage	0
4	IOUT Over current	0
3	VIN Under voltage	0
2	Temperature	0
1	CML(Comm. Memory Fault)	0
0	X	0

Summary of Supported PMBus Commands

This section outlines the PMBus command is outlined in order of increasing command codes with a quick reference table of all supported commands included at the end of the section. Each command will have the following basic information.

Command Name [Code]

Command support

Data format

Factory default

Additional information may be provided in tabular form or other format, if necessary.

PMBus™ SPECIFICATIONS

OPERATION [0x01]

Command support: On/Off Immediate and Margins (Act on Fault). Soft off with sequencing not supported and Margins (Ignore Fault) not supported. Therefore bits 6, 3, 2, 1 and 0 set as read only at factory defaults

Format	8 bit unsigned (bit field)							
Bit Position	7	6	5	4	3	2	1	0
Access	r/w	r	r/w	r/w	r	r	r	r
Function	ON/OFF		Vout Command		N/A		N/A	
Default Value	1	0	0	0	1	0	0	0

ON_OFF_CONFIG [0x02]

Command support: Bit 1 polarity will be set based upon module code [0=Negative on/off logic, 1=positive on/off logic to allow customer system to know hardware on/off logic.

Format	8 bit unsigned (bit field)							
Bit Position	7	6	5	4	3	2	1	0
Access	r	r	r	r	r	r	r/w	r
Function	(reserved)			Bit4 pu	Bit3 cmd	Bit2 cpr	Bit1 pol	Bit0 cpa
Default Value	0	0	0	1	1	1	0	1

CLEAR_FAULTS [0x03]

Command support: All functionality.

STORE_DEFAULT_ALL[0x11]

Command support: All functionality – Stores operating parameters to E2prom memory.

RESTORE_DEFAULT_ALL[0x12]

Command support: All functionality – Restores operating parameters from E2prom memory.

VOUT_MODE[0x20]

Command support: Supported. Factory default: 0x14 – indicates linear mode with exp = -9.

Format	8 bit unsigned (bit field)							
Bit Position	7	6	5	4	3	2	1	0
Access	r	r	r	r	r	r	r	r
Function	Mode(linear)				2's complement exponent			
Default Value	0	0	0	1	0	1	0	0

PMBus™ SPECIFICATIONS

VOUT_COMMAND [0x21]

Data format: 16 bit unsigned mantissa (implied exponent per VOUT_MODE)

Factory default: 5.00V (5.00 / 2⁻⁹ → 2560 = 0xA00)

Range limits (max/min): 6.0V/4.0V

Units: volt

Command support: Supported, except when Trim function is selected via MFR_C1_C2_ARA_CONFIG [0xE0].

VOUT_MARGIN_HIGH [0x25]

Range limits (max/min): 6.0V/4.0V

Units: volt

Command support: read/write support, full functionality except “Ignore faults”.

Note: Range cross-check - value must be greater than VOUT_MARGIN_LOW value.

VOUT_MARGIN_LOW [0x26]

Range limits (max/min): 6.0/4.0

Units: volt

Command support: read/write support, full functionality except “Ignore faults”.

Note: Range cross-check - value must be less than VOUT_MARGIN_HIGH value.

VIN_ON [0x35]

Range limits (max/min): 36/32

Units: volt

Command support: All functionality

Note: Special interlock checks between VIN_ON and VIN_OFF maintain a hysteresis gap and do not allow the OFF level to be higher than and ON level.

VIN_OFF [0x36]

Range limits (max/min): 35/31

Units: volt

Command support: All functionality

Note: Special interlock checks between VIN_ON and VIN_OFF maintain a hysteresis gap and do not allow the OFF level to be higher than and ON level.

IOUT_CAL_GAIN[0x38]

Data format: IOUT linear format

Command support: support for IOUT GAIN calibration (factor in flash), lockout per MFR_DEVICE_TYPE

PMBus™ SPECIFICATIONS

IOUT_CAL_OFFSET[0x39]

Data format: IOOUT linear format

Command support: support for IOOUT offset calibration (factor in flash), lockout per MFR_DEVICE_TYPE

VOOUT_OV_FAULT_LIMIT [0x40]

Range limits (max/min): 7.0/5.0 (See note 2)

Units: volt

Command support: All functionality

Note1: Range cross-check – value must be greater than VOOUT_COMMAND value.

Note2: The maximum OV Fault Limit equals the output set point plus 2V, up to 7V. This is an automatic module protection feature that will override a user-set fault limit if the user limit is set too high.

VOOUT_OV_FAULT_RESPONSE [0x41]

Command support:

Response settings (bits RSP0:1) – only a setting of 10, unit shuts down and responds according to the retry settings below, is supported.

Retry settings (bits RS0:2) – only settings of 000 (unit does not attempt to restart on fault) and 111 unit continuously restarts (normal startup) while fault is present until commanded off, bias power is removed or another fault condition causes the unit to shutdown.

Delay time setting (bits DT0:2) – only DT0:2 = 0 (no delay) supported.

Default Settings: The default settings for the VOOUT_OV_FAULT_RESPONSE command are;

The unit shuts down in response to a VOOUT over voltage condition.

The unit will continuously restart (normal startup) while the VOOUT over voltage condition is present until it is commanded off, bias power is removed or another fault condition causes the unit to shutdown.

The shutdown delay is set to 0 delay cycles.

Format	8 bit unsigned (bit field)							
Bit Position	7	6	5	4	3	2	1	0
Access	r	r	r/w	r/w	r/w	r	r	r
Function	RSP[1]	RSP[0]	RS[2]	RS[1]	RS[0]	DT[2]	DT[1]	DT[0]
Default Value	1	0	1	1	1	0	0	0

IOOUT_OC_FAULT_LIMIT [0x46]

Range limits (max/min): 80/64

Units: amp

Command support: All functionality

Note: Range cross-check – value must be greater than IOOUT_OC_WARN_LIMIT value.

PMBus™ SPECIFICATIONS

VOUT_OV_FAULT_RESPONSE [0x47]

Command support:

- Response settings (bits RSP0:1) – only settings of 11, unit shuts down and responds according to the retry settings below, is supported.
- Retry settings (bits RS0:2) – only settings of 000 (unit does not attempt to restart on fault) and 111 unit continuously restarts (normal startup) while fault is present until commanded off, bias power is removed or another fault condition causes the unit to shut down.
- Delay time setting (bits DT0:2) – only DT0:2 = 0 (no delay) supported.
- Default Settings: The default settings for the IOOUT_OC_FAULT_RESPONSE command are;
- The unit shuts down in response to an IOOUT over current condition.
- The unit will continuously restart (normal startup) while the IOOUT over current condition is present until it is commanded off, bias power is removed or another fault condition causes the unit to shut down.
- The shutdown delay is set to 0 delay cycles.

Format	8 bit unsigned (bit field)							
Bit Position	7	6	5	4	3	2	1	0
Access	r	r	r/w	r/w	r/w	r	r	r
Function	RSP[1]	RSP[0]	RS[2]	RS[1]	RS[0]	DT[2]	DT[1]	DT[0]
Default Value	1	1	1	1	1	0	0	0

IOOUT_OC_WARN_LIMIT [0x4A]

Range limits (max/min): 80/64

Units: amp

Command support: read/write support, functionality complete

Note: Range cross-check – value must be less than IOOUT_OC_FAULT_LIMIT value.

OT_FAULT_LIMIT [0x4F]

Range limits (max/min): 125/110

Units: degrees C.

Command support: All functionality

Note: Range cross-check – value must be greater than OT_WARN_LIMIT value

PMBus™ SPECIFICATIONS

OT_FAULT_RESPONSE [0x50]

Command support:

- Response settings (bits RSP0:1) – only setting of 10, unit shuts down and responds according to the retry settings below.
- Retry settings (bits RS0:2) – only settings of 000 (unit does not attempt to restart on fault) and 111 unit continuously restarts (normal startup) while fault is present until commanded off, bias power is removed or another fault condition causes the unit to shutdown.
- Delay time setting (bits 0-2) – only DT0:2 = 0 (no delay) supported.
- Default Settings: The default settings for the OT_FAULT_RESPONSE command are;
- The unit shuts down in response to an over-temperature condition.
- The unit will continuously restart (normal startup) while the over-temperature condition is present until it is commanded off, bias power is removed or another fault condition causes the unit to shut down.
- The shutdown delay is set to 0 delay cycles.

Format	8 bit unsigned (bit field)							
Bit Position	7	6	5	4	3	2	1	0
Access	r	r	r/w	r/w	r/w	r	r	r
Function	RSP[1]	RSP[0]	RS[2]	RS[1]	RS[0]	DT[2]	DT[1]	DT[0]
Default Value	1	0	1	1	1	0	0	0

OT_WARN_LIMIT [0x51]

Range limits (max/min): 125/100

Units: degrees C.

Command support: All functionality

Note: Range cross-check – value must be less than OT_FAULT_LIMIT value.

VIN_OV_FAULT_LIMIT [0x55]

Range limits (max/min): 87/79

Units: volt

Command support: All functionality

VIN_OV_FAULT_RESPONSE [0x56]

Default Settings: The default settings for the VIN_OV_FAULT_RESPONSE command are;

The unit shuts down in response to a VIN over voltage condition.

The unit will continuously prepares to restart (normal startup) while the VIN over voltage condition is present until it is commanded off, bias power is removed, the VIN over voltage condition is removed, or another fault condition causes the unit to shut down.

The shutdown delay is set to 0 delay cycles.

PMBus™ SPECIFICATIONS

Format	8 bit unsigned (bit field)							
Bit Position	7	6	5	4	3	2	1	0
Access	r	r	r/w	r/w	r/w	r	r	r
Function	RSP[1]	RSP[0]	RS[2]	RS[1]	RS[0]	DT[2]	DT[1]	DT[0]
Default Value	1	1	0	0	0	0	0	0

POWER_GOOD_ON [0x5E]

Range limits (max/min): 5.5/3.0

Units: volt

Command support: full support

Note: Range cross-check – value must be greater than POWER_GOOD_OFF value by 0.8V.

POWER_GOOD_OFF [0x5F]

Range limits (max/min): 5.5/3.0

Units: volt

Command support: full support

Note: Range cross-check – value must be less than POWER_GOOD_ON value by 0.8V.

STATUS_WORD [0x79]

Command support: full implementation for supported functions (note: Fans, MFR_SPECIFIC, Unknown not supported)

Format	8 bit unsigned (bit field)							
Bit Position	15	14	13	12	11	10	9	8
Access	r	r	r	r	r	r	r	r
Function	VOUT	I/POUT	INPUT	MFR_SPEC	#PWR_GOOD	FAN ¹	OTHER ¹	UNKNOWN ¹

Format	8 bit unsigned (bit field)							
Bit Position	7	6	5	4	3	2	1	0
Access	r	r	r	r	r	r	r	r
Function	BUSY ¹	OUTPUT_ OFF	VOUT_OV_ FAULT	IOUT_OC_ FAULT	VIN_UV_ FAULT	TEMP	CML	NONE OF ABOVE ¹

Note1: Not supported

PMBus™ SPECIFICATIONS

STATUS_VOUT [0x7A]

Command support: VOUT_OV_FAULT support, all bit reset supported

Format	8 bit unsigned (bit field)							
Bit Position	7	6	5	4	3	2	1	0
Access	r/reset ¹	r/reset	r/reset	r/reset	r/reset	r/reset	r/reset	r/reset
Function	VOUT_OV_FAULT	VOUT_OV_WARN ¹	VOUT_UV_WARN ¹	VOUT_UV_FAULT ¹	VOUT_MAX_WARN ¹	TON_MAX_FAULT ¹	TOFF_MAX_WARN ¹	VOUT_TRACKING_ERROR ¹

Note 1 - Not supported

STATUS_IOUT [0x7B]

Command support: IOUT_OC_FAULT support, all bit reset supported

Format	8 bit unsigned (bit field)							
Bit Position	7	6	5	4	3	2	1	0
Access	r/reset ¹	r/reset	r/reset	r/reset	r/reset	r/reset	r/reset	r/reset
Function	IOUT_OC_FAULT	IOUT_OC_LV_FAULT ¹	IOUT_OC_WARN	IOUT_UC_FAULT ¹	Current Share Fault ¹	In Power Limiting Mode ¹	POUT_OP_FAULT ¹	POUT_OP_WARN ¹

Note 1 - Not supported

STATUS_INPUT [0x7C]

Command support: VIN_OV_FAULT support, all bit reset supported

Format	8 bit unsigned (bit field)							
Bit Position	7	6	5	4	3	2	1	0
Access	r/reset ¹	r/reset	r/reset	r/reset	r/reset	r/reset	r/reset	r/reset
Function	VIN_OV_FAULT	VIN_OV_WARN ¹	VIN_UV_WARN ¹	VIN_UV_FAULT	Unit Off (low input voltage)	IIN_OC_FAULT ¹	IIN_OC_WARN ¹	PIN_OP_WARN ¹

Note 1 - Not supported

STATUS_TEMPERATURE [0x7D]

Command support: OT_WARN, OT_FAULT supported, all bit reset supported

Format	8 bit unsigned (bit field)							
Bit Position	7	6	5	4	3	2	1	0
Access	r/reset ¹	r/reset	r/reset	r/reset	r/reset	r/reset	r/reset	r/reset
Function	OT_FAULT	OT_WARN	UT_WARN ¹	UT_FAULT ¹	reserved	reserved	reserved	reserved

Note 1 - Not supported

PMBus™ SPECIFICATIONS

READ_VIN [0x88]

Command support: full support

READ_VOUT [0x8B]

Command support: full support

READ_IOUT [0x8C]

Command support: full support

READ_TEMPERATURE_1 [0x8D]

Range cross-check - value must be greater than VOUT_MARGIN_LOW value.

Command support: full support

MFR_VOUT_READ_CAL_GAIN [0xD1]

Command support: support for VOUT gain calibration (factor in flash), lockout per MFR_DEVICE_TYPE

MFR_VOUT_READ_CAL_OFFSET [0xD2]

Command support: support for VOUT offset calibration (factor in flash), lockout per MFR_DEVICE_TYPE

MFR_VIN_READ_CAL_GAIN [0xDD]

Factory default:194

Range limits (max/min): 210/180

Command support: support for VIN gain calibration (factor in flash), lockout per MFR_DEVICE_TYPE

MFR_VIN_READ_CAL_OFFSET [0xDE]

Range limits (max/min): 200/0

Units: N/A

Command support: support for VIN offset calibration (factor in flash), lockout per MFR_DEVICE_TYPE

MFR_FW_REV [0x9B]

Range limits (max/min): 0 - 0xff (0.00 – 15.15)

Units: N/A

Command support: full read support

PMBus™ SPECIFICATIONS

MFR_C1_C2_ARA_CONFIG [0xE0]

Command support: full support:

Command	MFR_C1_C2_ARA_CONFIG							
Format	8 bit unsigned (bit field)							
Bit Position	7	6	5	4	3	2	1	0
Access	r	r	r	r/w	r/w	r/w	r/w	r/w
Function	Reserved			ARA	Assignment Table			
Default Value	0	0	0	0	0	0	0	0

Assignment Table

Bit	Description	Value	Meaning
7:5	Reserved	000	Reserved
4	ARA	0	ARA not functional, module remains at resistor programmed address when SMBLAERT is asserted
		1	ARA functional, module responds to ARA only, when SMBLAERT is asserted
3:0	PIN Configuration	0000	T/C1 pin: ON/OFF (Secondary) C2 pin: POWER_GOOD
		0001	T/C1 pin: TRIM C2 pin: POWER_GOOD
		0010	T/C1 pin: TRIM C2 pin: ON/OFF (Secondary)

MFR_C2_LOGIC [0xE1]

Command support: full support (bits 0 and 1) as follows:

Command	MFR_C2_ARA_LOGIC							
Format	8 bit unsigned (bit field)							
Bit Position	7	6	5	4	3	2	1	0
Access	r	r	r	r	r	r	r/w	r/w
Function	Reserved						On/Off(primary & secondary) combination	logic
Default Value	0	0	0	0	0	0	0	0

PMBus™ SPECIFICATIONS

Bit	Description	Value	Meaning
7:2	Reserved	000000	Reserved
1	ON/OFF Configuration	0	Secondary side on/off pin state, when mapped to either T/C1 or C2, is ignored
		1	AND – Primary and Secondary side on/off
0	Secondary Side ON/OFF Logic	0	Negative Logic (Low Enable: Input < 0.8V wrt Vout(-))
		1	Positive Logic (High Enable: Input > 2.2V wrt Vout(-))

MFR_PGOOD_POLARITY [0xE6]

Command support: full support (bit 0) as follows:

Bit 0:

0 = Negative PGOOD logic (module PGOOD asserted when pin is LO, PGOOD de-asserted when pin is HI)

1 = Positive PGOOD logic (module PGOOD de-asserted when pin is LO, PGOOD asserted when pin is HI)

Command	MFR_PGOOD_POLARITY							
Format	8 bit unsigned (bit field)							
Bit Position	7	6	5	4	3	2	1	0
Access	r	r	r	r	r	r	r	r/w
Function	Reserved							logic
Default Value	0	0	0	0	0	0	0	1

MFR_MODULE_DATE_LOC_SN [0xF0]

Command support: read/write support for 12 byte block, lockout per MFR_DEVICE_TYPE

PMBus™ SPECIFICATIONS

PMBus™ Command List

The main PMBus commands described in the PMBus 1.2 specification are supported by the module. Partial PMBus commands are fully supported; Partial PMBus commands have difference with the definition in PMBus 1.2 specification. The details about all the supported PMBus commands are to be decided later.

Command Code	Command Name	Default Value	Access type	Data Bytes	Data Format	Description
01h	OPERATION	0x80	R/W	1	Bit field	Turn the module on or off by PMBUS command
03h	CLEAR_FAULTS	-	S	0		Clear any fault bits that have been set
11h	STORE_DEFAULT_ALL	-	S	0		Stores operating parameters from RAM to data flash (This command is effective to the parameter of all command in the table.)
12h	RESTORE_DEFAULT_ALL	-	S	0		Restores operating parameters from data flash to RAM (This command can't be issued when the power unit is running.)
20h	VOUT_MODE	0x17	S	1	Mode + exp	To read Vo data format
21h	VOUT_COMMAND	5V	R/W	2	V _{OUT} Linear	Sets the output voltage
25h	VOUT_MARGIN_HIGH	5.7V	R/W	2	V _{OUT} Linear	The VOUT_MARGIN_HIGH command loads the unit with the voltage to which the output is to be changed when the OPERATION command is set to "Margin High."
26h	VOUT_MARGIN_LOW	4V	R/W	2	V _{OUT} Linear	The VOUT_MARGIN_LOW command loads the unit with the voltage to which the output is to be changed when the OPERATION command is set to "Margin Low."
35h	VIN_ON	34V	R/W	2	V _{IN} linear	Sets the turn on voltage threshold of Vin under voltage lockout.
36h	VIN_OFF	32V	R/W	2	V _{IN} Linear	Sets the value of input, in volts, at which the unit should stop power conversion.
38h	IOUT_CAL_GAIN	1000	R/W	2	I _{OUT} Linear	This is used to compensate for set the ratio of the voltage at the current sense pins to the sensed current for the READ_IOUT command.
39h	IOUT_CAL_OFFSET	401	R/W	2	I _{OUT} Linear	This is used to compensate for offset errors in the READ_IOUT command.
40h	VOUT_OV_FAULT_LIMIT	7V	R/W	2	V _{OUT} Linear	Sets the output overvoltage fault threshold. (Must be higher than the value of VOUT_COMMAND and VOUT_OV_WARN_LIMIT) Range:11V to 16V
41h	VOUT_OV_FAULT_RESPONSE	0xB8	R	1	Bit field	Instructs what action to take in response to an output overvoltage fault.
46h	IOUT_OC_FAULT_LIMIT	75A	R/W	2	I _{OUT} Linear	Sets the value of the output current that causes an output overcurrent warning
47h	IOUT_OC_FAULT_RESPONSE	0xF8	R	1	Bit field	Reads the action taken in response to an output overcurrent fault.

PMBus™ SPECIFICATIONS

Supported PMBus command List:

Command Code	Command Name	Default Value	Access type	Data Bytes	Data Format	Description
4Ah	IOUT_OC_WARN_LIMIT	70A	R/W	2	I _{OUT} Linear	Sets the threshold, in amperes, for the output overcurrent warning.
4Fh	OT_FAULT_LIMIT	120degC	R/W	2	TEMP linear	Sets the over temperature fault threshold.
50h	OT_FAULT_RESPONSE	0xB8	R	1	Bit field	Instructs what action to take in response to an over temperature fault.
51h	OT_WARN_LIMIT	110degC	R/W	2	Linear	Sets a threshold causing a temperature high warning.
55h	VIN_OV_FAULT_LIMIT	85V	R/W	2	Linear	Sets the input overvoltage fault threshold.
56h	VIN_OV_FAULT_RESPONSE	0xC0	R	1	Bit field	Instruct what action to take in response to an over Vin fault
5Eh	POWER_GOOD_ON	4.2V	R/W	2	V _{OUT} Linear	Sets the output voltage at which the bit 3 of STATUS_WORD high byte should be asserted.
5Fh	POWER_GOOD_OFF	3.5V	R/W	2	V _{OUT} Linear	Sets the output voltage at which the bit 3 of STATUS_WORD high byte should be negated.
60h	TON_DELAY	40ms	R/W	2	Time Linear	Sets the delay time between a valid enable condition and the beginning of the output ramp to regulation
61h	TON_RISE	20ms	R/W	2	Time Linear	Sets the ramp-up time from 0V to regulation
79h	STATUS_WORD	-	R	2	Bit field	Returns the information with a summary of the module's fault/warning
7Ah	STATUS_VOUT	-	R	1	Bit field	Output voltage related faults and warnings
7Bh	STATUS_IOUT	-	R	1	Bit field	Output Current related faults and warnings
7Ch	STATUS_INPUT	-	R	1	Bit field	Input related faults and warnings
7Dh	STATUS_TEMPERATURE	-	R	1	Bit field	Temperature related faults and warnings
88h	READ_VIN	-	R	2	V _{IN} linear	Return the input voltage of the module
8Bh	READ_VOUT	-	R	2	V _{OUT} Linear	Return the output voltage of the module
8Ch	READ_IOUT	-	R	2	I _{OUT} Linear	Read the load current
8Dh	READ_TEMP1	-	R	2	TEMP Linear	Ambient temperature sensor
98h	PMBUS_REVISION	1.2	R	1	Bit Field	Reads the PMBus revision number
9Bh	MFR_FW_REV	AA	R/W	1	8 bit	Read the FW revision
D1h	MFR_VOUT_READ_CAL_GAIN	MS	R/W	2	unsigned	Read the gain correction
D2h	MFR_VOUT_READ_CAL_OFFSET	MS	R/W	2	U 16bit	Read the offset

PMBus™ SPECIFICATIONS

Supported PMBus command List:

Command Code	Command Name	Default Value	Access type	Data Bytes	Data Format	Description
DDh	MFR_VIN_READ_CAL_GAIN	MS	R/W	2	U 16 bit	Read the gain correction
DEh	MFR_VIN_READ_CAL_OFFSET	MS	R/W	2	V _{IN} linear	Read the offset
E0h	MFR_C1_C2_ARA_CONFIG	0x01	R/W	1	Bit field	Configures the C2 pin (secondary on/off pin) function and logic
E1h	MFR_C2_LOGIC	0x01	R/W	1	Bit field	Configure Power Good logic
E6h	MFR_PGOOD_POLARITY	0x01	R/W	1	Bit field	Set the logic polarity of the signal.
F0h	MFR_MOD_DATE_LOC_SN	China. SZ	R/W	12	8 bit char	
	MS=Module specific		Read byte			

SOLDERING INFORMATION

Soldering

The product is intended for standard manual or wave soldering.

	Product Requirement	Product Name
R6	Wave soldering	ADO300-48S05B-6L ADO300-48S05PB-6L ADO300-48S05B-6LI ADO300-48S05-6L ADO300-48S05-6LI

When wave soldering is used, the temperature on pins is specified to maximum 260 °C for maximum 7s.

When soldering by hand, the iron temperature should be maintained at 300 °C ~ 380 °C and applied to the converter pins for less than 10s. Longer exposure can cause internal damage to the converter. Cleaning of solder joint can be performed with cleaning solvent IPA or simulative.

The below products are intended for standard reflow soldering

	Product Requirement	Product Name
R6	Reflow soldering	ADO300-48S05-6L ADO300-48S05-6LI

When reflow soldering is used, Please refer to following fig for recommended temperature profile parameters..

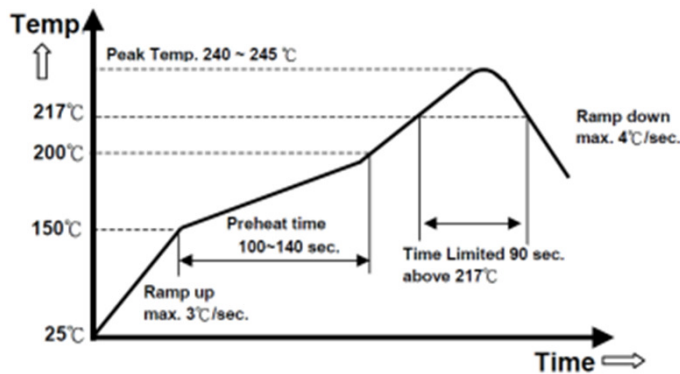

RECORD OF REVISION AND CHANGES

Issue	Date	Description	Originators
1.0	12.13.2017	First Issue	Kim Hou
1.1	12.06.2019	Update the soldering spec	A. Zhang
1.2	02.25.2020	Update the RoHS information	A. Zhang
1.3	03.11.2020	Update Mechanical drawing	K. Wang
1.4	04.25.2021	1. Update Mechanical Drawing 2. Add ADO300-48S05B-4L 3. Update safety part	K. Ayaz
1.5	05.17.2021	Add an example on PMBus address	K. Ma
1.6	02.22.2022	1. Update typo and add thermal derating curve unit. 2. Add PMBus picture in top page	K. Wang



For international contact information,
visit advancedenergy.com.

powersales@aei.com (Sales Support)
productsupport.ep@aei.com (Technical Support)
+1 888 412 7832

ABOUT ADVANCED ENERGY

Advanced Energy (AE) has devoted more than three decades to perfecting power for its global customers. AE designs and manufactures highly engineered, precision power conversion, measurement and control solutions for mission-critical applications and processes.

Our products enable customer innovation in complex applications for a wide range of industries including semiconductor equipment, industrial, manufacturing, telecommunications, data center computing, and medical. With deep applications know-how and responsive service and support across the globe, we build collaborative partnerships to meet rapid technological developments, propel growth for our customers, and innovate the future of power.

PRECISION | POWER | PERFORMANCE

Specifications are subject to change without notice. Not responsible for errors or omissions. ©2020 Advanced Energy Industries, Inc. All rights reserved. Advanced Energy®, and AE® are U.S. trademarks of Advanced Energy Industries, Inc.