

Programmable Controllers

CS Series PLC-based Process Control

Fully Integrated Sequence and Process Control
for the Ideal Control System for Every Application



» Down-sizing

» Easy Engineering

» High Reliability

OMRON's PLC-based Process Control = Smart Proc

General-purpose PLCs provide everything from simple loop control to advanced process control to

A Breakthrough

The accelerating wave of globalization calls for rebuilding systems to cope with changes in demand. And now OMRON has taken its wealth of technical know-how in factory automation and process control technology to create a PLC-based process control system.



- *DCS functionality in a PLC*
- *Analog Units with signal conversion functions*
- *A scalable system configuration*



- *Function block programming*
- *Sequence programming using either step ladders or sequence tables*
- *A direct link to HMI products*

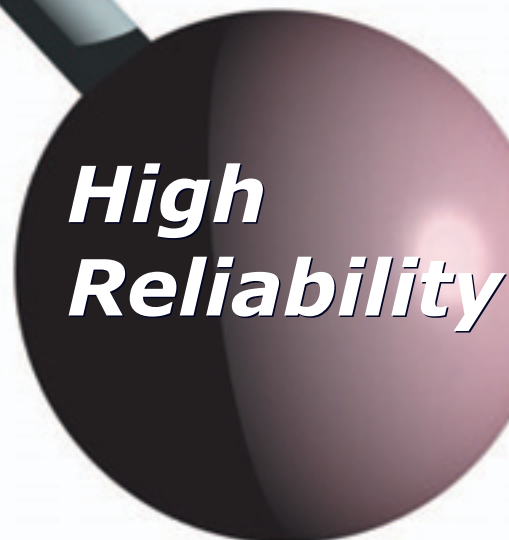
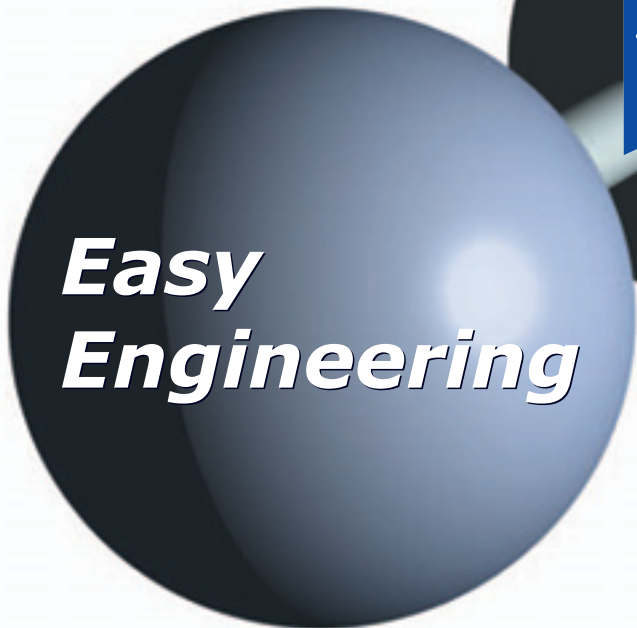

- *Duplex operation supported*
- *Complete maintenance functions*

ess Control

meet customer needs.

The open nature of the PLCs is joined by integrating hardware, software, and networking to meet your needs.

Increasing amounts of information, standardization, and open standards form the basis for achieving hardware and networking capabilities for process control. A wide range of software that can be easily used by design, development, and maintenance personnel makes operating and maintaining the system far easier.

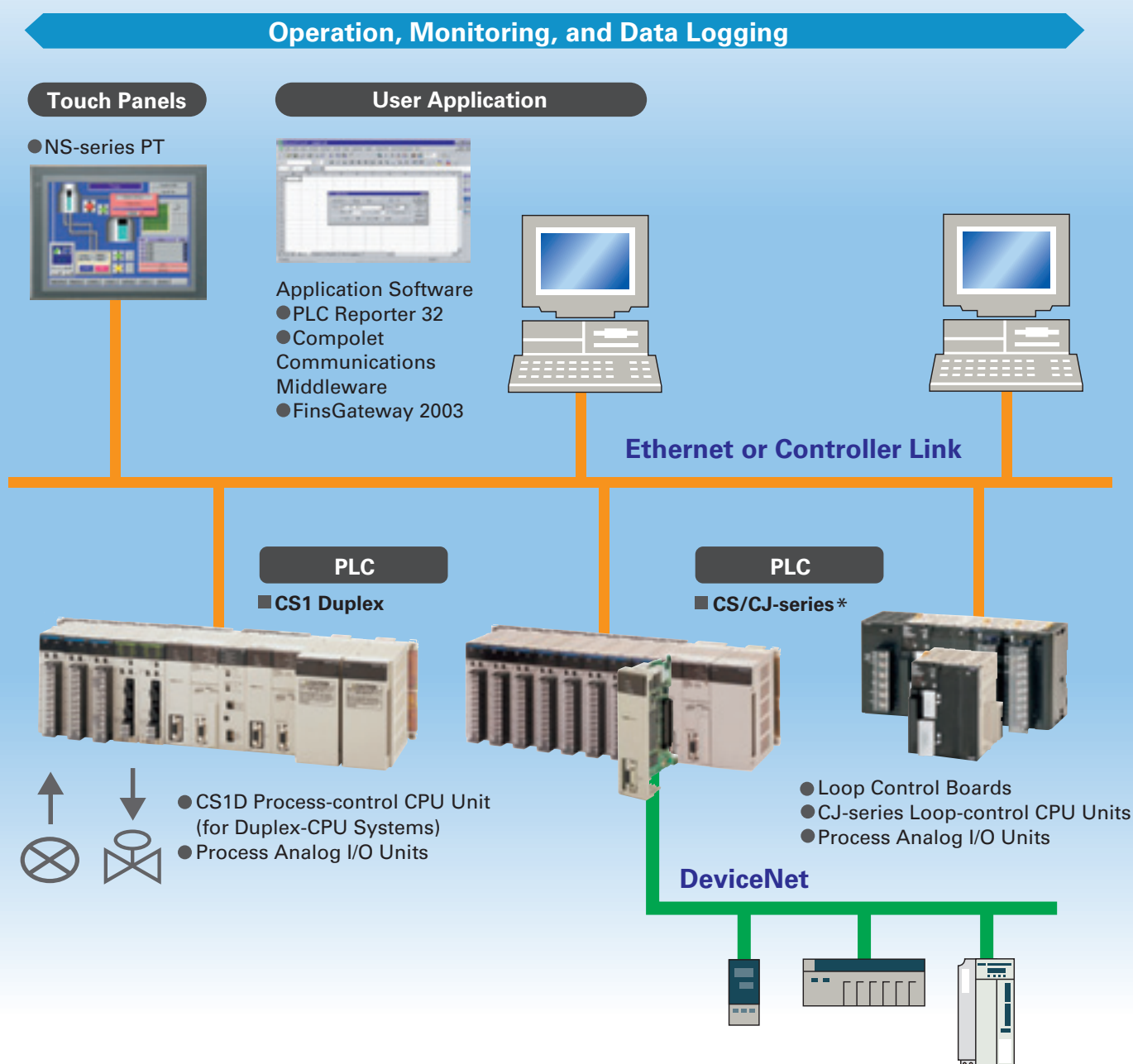

*For details on the CJ Series, refer to the *Loop-control CPU Units Catalog* (R128-E1-01).

Windows is a registered trademark of the Microsoft Corporation. DeviceNet, DeviceNet Safety, CompoNet, and EtherNet/IP are registered trademarks of the ODVA. Other company names and product names are the trademarks or registered trademarks of the respective companies.

Going Beyond the Traditional Limits of PLCs with PLC-based Process Control

Reducing the Total Cost of Ownership from Initial Costs through Running Costs. PLC-based Process Control Meets Customer Needs

Existing System Problems

Systems are large, meaning high initial costs.

The over-spec nature of a distributed control system (DCS) increased costs. PLCs, however, could not provide the required process control capabilities, and signal conversion with isolators and other devices was required for I/O. It was just not possible to achieve the ideal system for a specific application.

Existing DCS

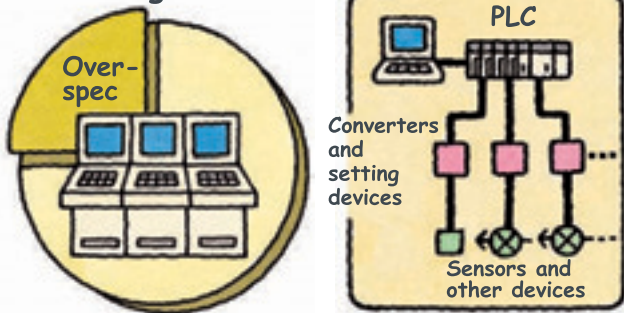

PLC-based Process Control

Down Sizing
Cut costs, Save space, Reduce labor

PLCs provide the some of the functions and performance of DCS while also providing the advanced features of PLCs: Open specs, easy maintenance, and cost performance. A wide range of Isolated-type Analog Units helps to save space and greatly reduces system costs.

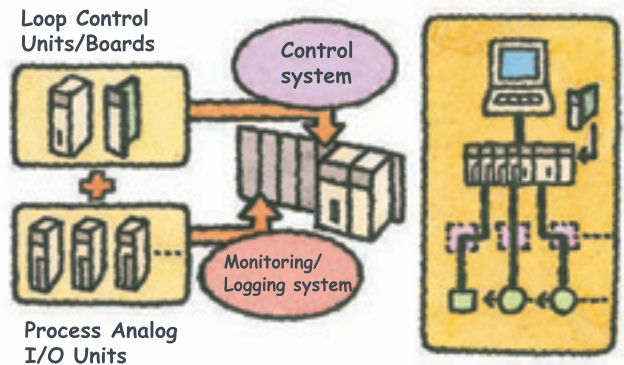

Running costs are high because maintenance and modifications require specialists.

The manufacturer must be relied upon for everything from system construction to maintenance. Even simple changes to parameters cannot be performed in-house. And, it's nearly impossible to use general-purpose devices and software (such as HMI devices or Windows-based software) when modifying the system.

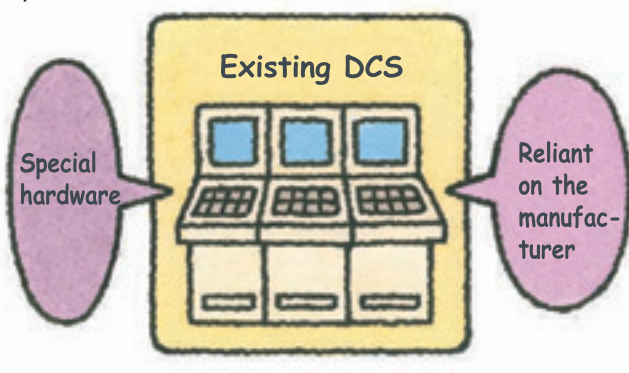

Easy Engineering
Engineering is simple when you can program with function blocks.

Paste function blocks in a window just like you were creating a flow sheet, and then connect the blocks with the mouse to graphically program a wide range of process control. And with a PLC, it's easy to incorporate general-purpose HMI devices and software (such as touch panels and SCADA software).

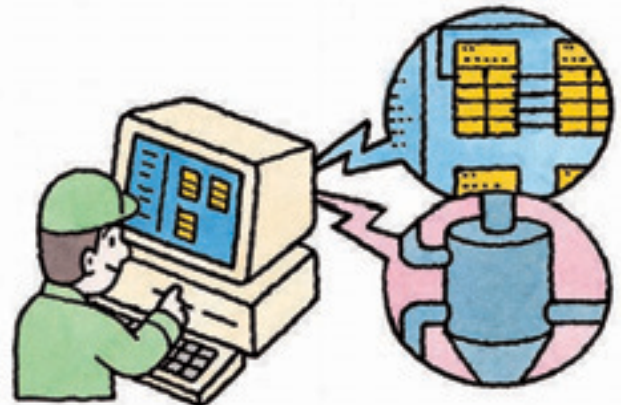

Avoid Problems and Minimize Risks with a Duplex System

Increase the reliability of the facilities and devices with a Duplex PLC-based Process Control System.

If an error occurs in the active CPU Unit, the standby CPU Unit takes over in an instant (using the hot standby method) so that system operation continues essentially unaffected. Other duplex variations are also possible. For example, instead of duplexing the CPU Unit, Power Supply Unit, and Controller Link Unit, a system can be constructed with a Single-CPU Unit and only a duplex Power Supply Unit or only a duplex Controller Link Unit.

A duplex system means rapid recovery for errors .

Replace Units with power supplied or even while the system is running, including CPU Units (Duplex-CPU system), Power Supply Units, Communications Units, Basic I/O Units, and Special I/O Units.

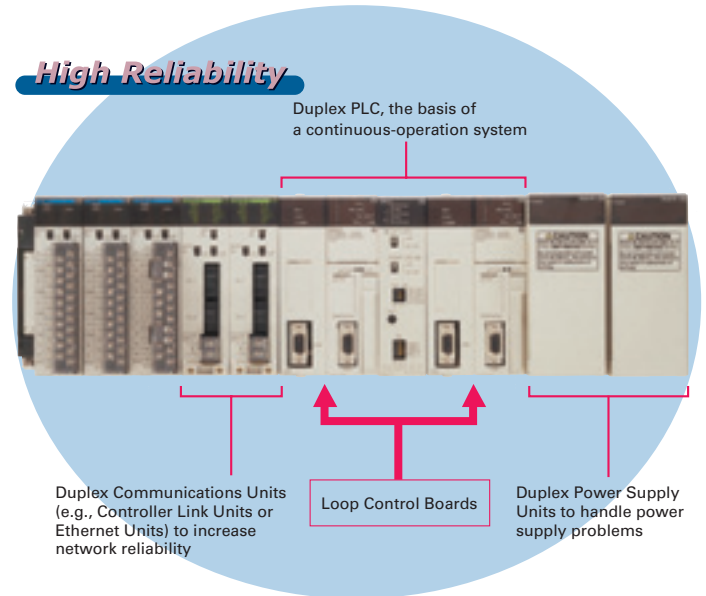

PLC-based Process Control Application Examples

Application Example in a Food Plant

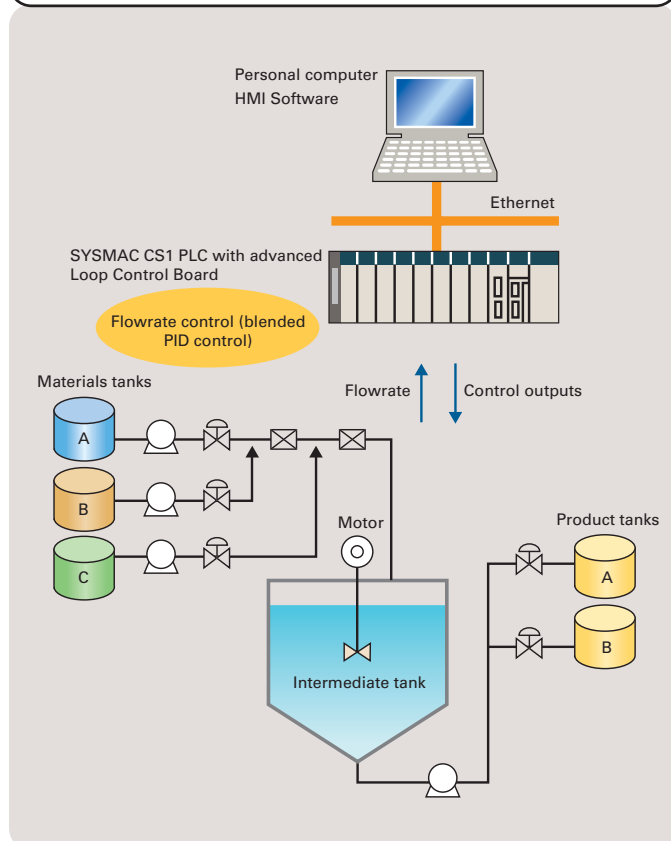

Application Example in a Chemical Plant

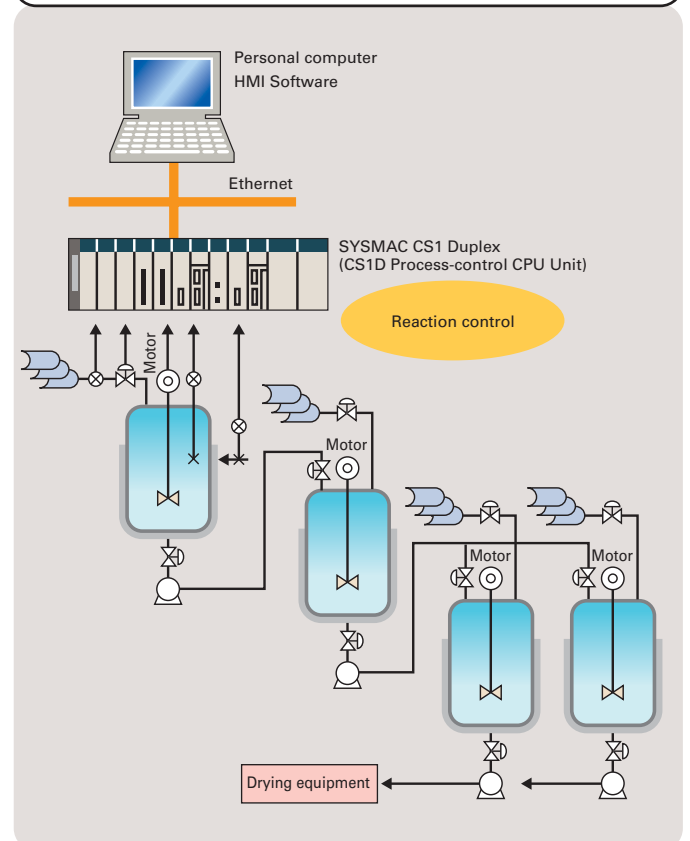

A Revolutionary Solution to Process Control

Advanced Controller Functions in a PLC

For easier loop control, for advanced PLC-based analog control:
The New SYSMAC CS1-based Solution

Existing System Problems

Excessive installation space is required.

When using more than one controller for multi-loop control, the control panel is just too big. And specification changes required altering the control panel, making changes difficult.

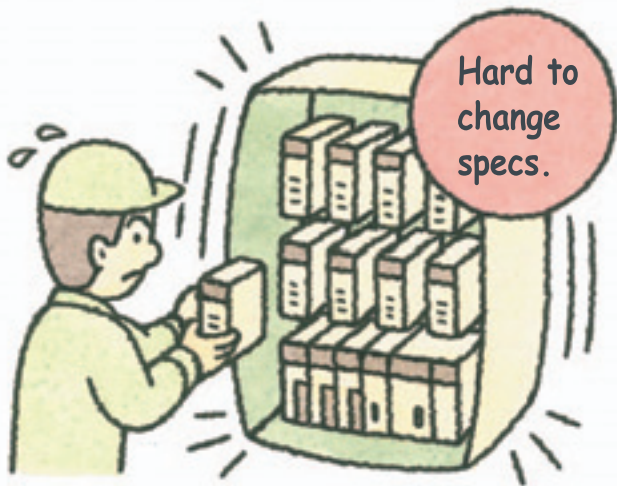

Programming communications with the controllers is extremely difficult.

Communications must be programmed to input data to the PLC. And communications time can restrict control performance. The more controllers that are used, the more difficult maintenance becomes.

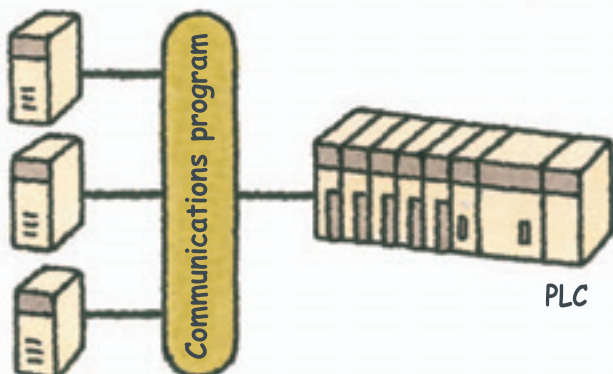

PLC-based Process Control

Down Sizing
Consolidate the functions of many controllers

Programming is as simple as combining the function blocks required by the application. To increase the number of controlled loops, just add them to the program. HMI windows can also be created easily using a wide range of utility software.

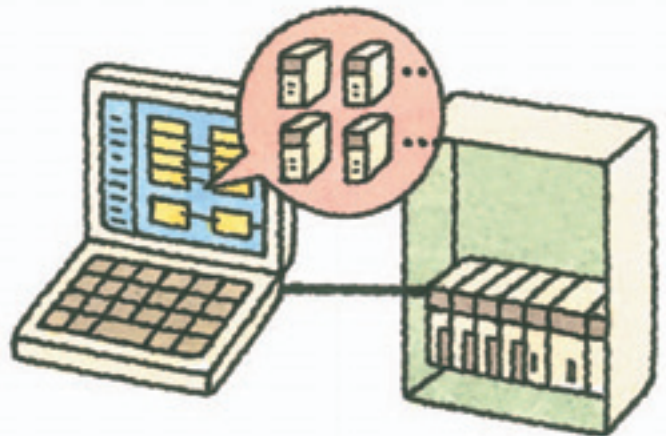

Easy Engineering
Advanced controller functions are built into the CS1 PLCs. No programming is required for communications.

The Loop Control Boards and Units were designed for the CS1 PLCs and require no communications programming. High-speed, flexible data links can be created with the PLC to increase control performance.

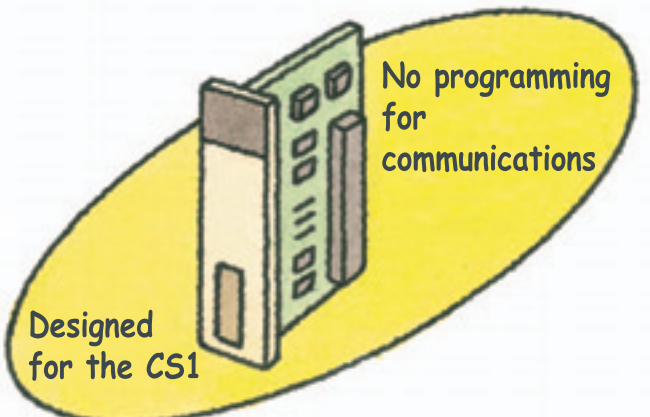

Gradient Temperature Control for Planar Temperature Control Across Multiple Points

Note: CS1W-LCB05-GTC only.

Gradient temperature control equalizes the temperatures at multiple points, providing high-quality heat processing, reducing energy loss until temperatures stabilize, and saving labor in adjustments due to interference between heaters.

Example: Planar Temperature Control of Multi-stage Furnaces, Wafer and Glass Surface Temperatures, and Other Applications.

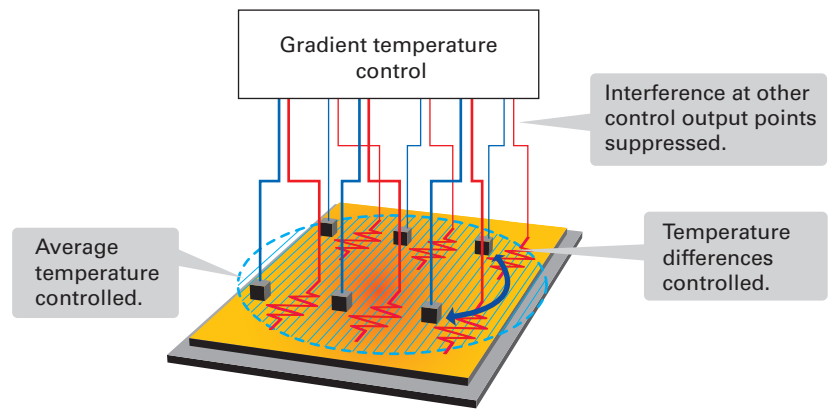

For details, refer to the *SYSMAC CS/CJ Series Controllers for Gradient Temperature Control Catalog (R141)*.

Compact CJ-series Loop-control CPU Units ideal for equipment built-in controller applications have been added to the series, further expanding the selection to suit the application.

Processing facility

Machinery (built-in devices)

CS1W-LCB01/05
CS-series/CS1D-S
Loop Control Board



CS1D
Process-control CPU Unit



CJ1G-CPU4□P
CJ-series Loop-control
CPU Unit



CJ1W-TC□□□
CJ-series Temperature
Control Unit

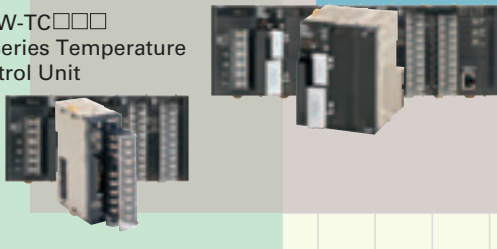

Easy

High-speed and highly reliable (duplex)

For details on the CJ Series, refer to the *Loop-control CPU Units Catalog (R128)*.

The Smart Products that Configure OMRON P

Loop Control Boards (LCBs)

Packed with complete DCS functionality, the LCBs are programmed with function blocks designed specifically for process control. By combining function blocks, a wide array of control methods, from basic PID control to cascade and feed-forward control can be easily configured. The LCB is used in combination with I/O Units to perform I/O operations.

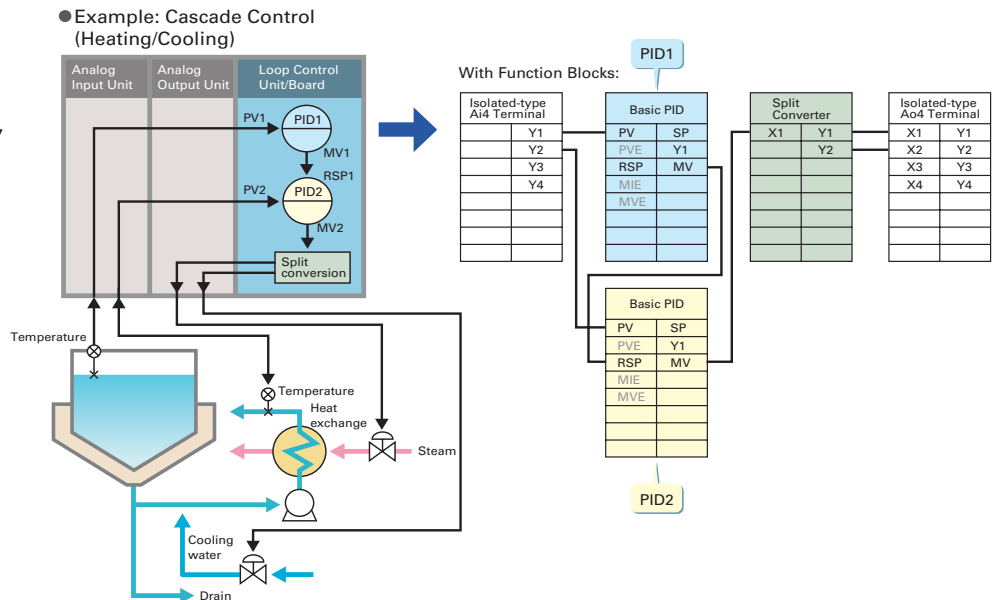

Process Analog I/O Units

These Analog I/O Units provide the functionality of isolators, power supplies, signal converters, and other devices. The built-in functions, such as measurement value alarms, rate-of-change calculations, and square roots, have enabled major savings in cost and space compared with previous systems. High-resolution Models and 8-point Input Models are also available. By combining the Units, logging/monitoring systems can be constructed, or the Units can be used together with LCBs to construct complete process control systems. Parameters can be easily displayed and set in an easy-to-understand form without special tools.

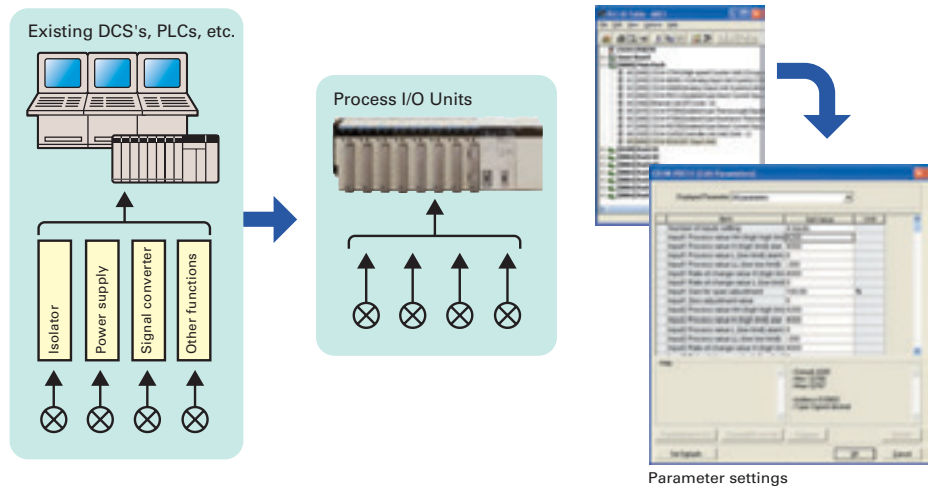

SYSMAC CS1D-series Duplex PLCs

Process control system redundancy is easily achieved by mounting Process-control CPU Units to the SYSMAC CS1D system. A duplex system can greatly reduce risk in chemical plants, ship boiler systems, semiconductor utilities, or anywhere reliability is demanded.



● Replace Units without Stopping the System.

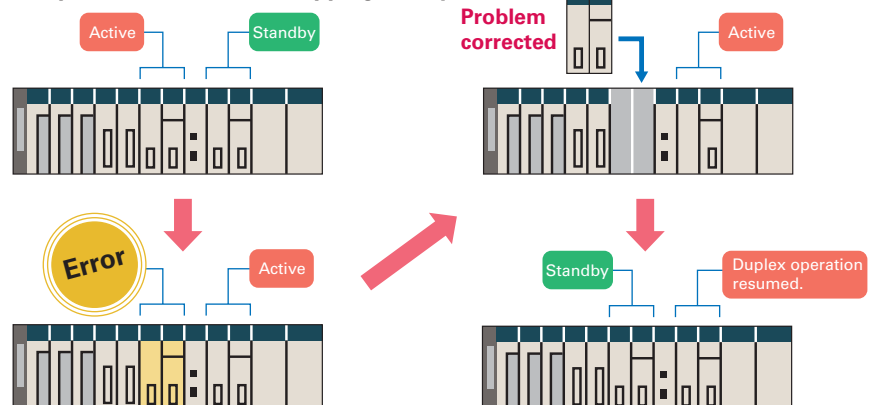

Process Control

The required number of engineering steps is reduced by software that enables analog control programming by combining function blocks and easy connection to HMI devices.

CX-One

Integrated Package Tool

The CX-One is an integrated software package that includes the CX-Programmer PLC Support Software and CX-Process Loop Controller Support Software, as well as the CX-Designer PT Support Software. The CX-One provides inter-software information and settings inheritance for complete system-level support. Even advanced parameters from CPU Unit to CPU Bus Unit parameters through FA network startup can be easily set without relying on user manuals.

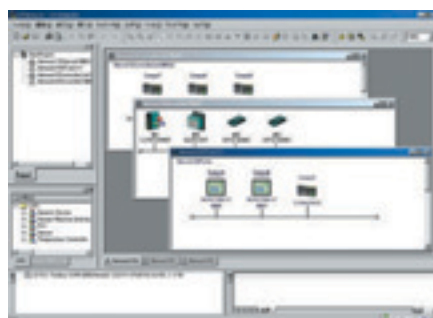

Network Support Software:
CX-Integrator

CX-Process Tool

Programming

Program graphically by pasting function blocks for PID control, square root calculations, or other functions in a window and then connect them with the mouse. Multiple function blocks can be grouped together to define a single user-defined function block. Function blocks can also be used in sequence tables and step ladders for sequence control programming.

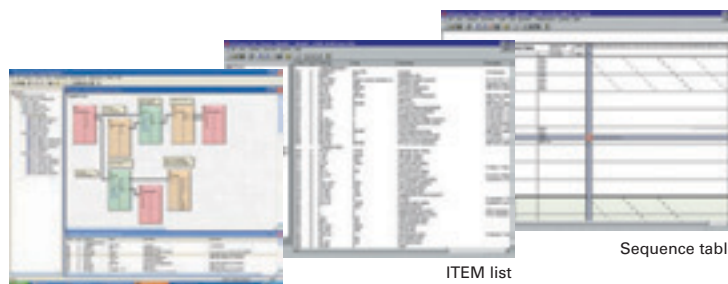

Block connection diagrams

ITEM list

Sequence table

Operation and Debugging

Engineering is simplified by a host of debugging functions that help in setting up the program.

- ITEM lists for individual function blocks can be monitored or settings can be changed.
- Parameters can be easily monitored or changed on tuning windows (up to 4 windows can be started simultaneously).
- Tuning data can be saved in CSV format.
- Individual function blocks can be added or deleted during operation.
- Connection, tag, and comment data can be downloaded to or uploaded from a Memory Card in a Loop Control Board (see note) or CPU Unit.

Note: Except for CS1D Process-control CPU Units.

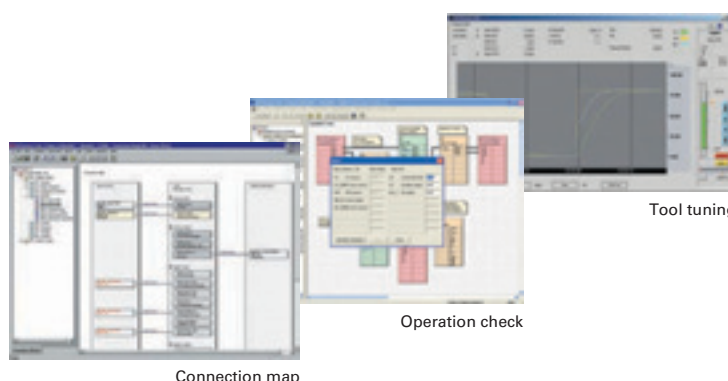

Connection map

Operation check

Tool tuning

Progressively Easier Handling New Functions for the LCB01/05 Unit Ver. 3.5 with CX-Process Tool Ver. 5.2

Even Easier to Use Display Values in Engineering Units

With a simple setting, analog data in the PLC can easily be converted to any engineering unit for display. There is no longer any need for a program to convert from normalized data (0% to 100%) to engineering data.

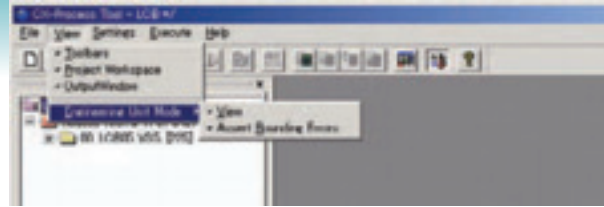

Engineering Unit Mode Switching Function

| ITEM | Type | Unit/Setting | Data | Units Name |
|------|------|--------------|--------|-------------------------|
| 000 | Q | High SP | 115.00 | High/High alarm setting |
| 009 | Q | High LSP | 100.00 | High alarm setting |
| 010 | Q | L SP | 0.00 | Low alarm setting |
| 011 | Q | LL SP | -15.00 | Low/low alarm setting |
| 017 | Q | ALC | 0.00 | Alarm stop switch |
| 023 | Q | SP W | 0.00 | Local Set Point setting |

ITEM Setting Window

Even Easier to Use Segment Program 3

The maximum number of steps has been increased from 30 to 100 to support a wider range of temperature control applications.

●Up to 100 Steps for Program Operation

Set the set point, time width, and PID bank (PID set) for up to 100 steps in the Loop Controller to automatically switch these parameters at the specified times. Setting up to 100 steps makes program control ideal for controlling complex batch processing. And uploading and downloading program data makes it easy to save and update parameter settings.

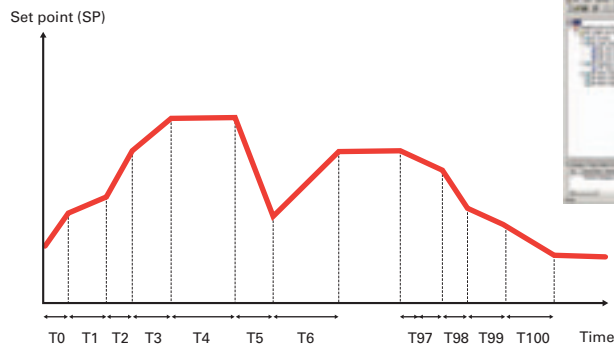

Even Easier to Use Segment Program Edit Window

The display format of the Segment Program Setting Window has been changed to the table format, making it easier to understand intuitively and thus saving time.

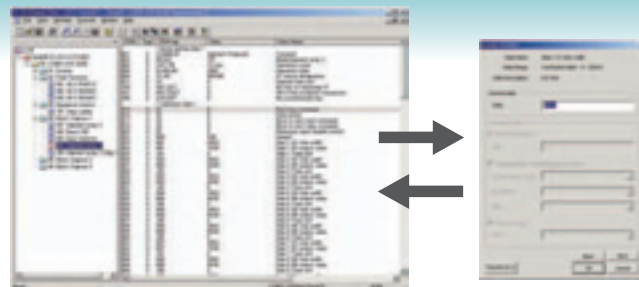

Previous Program Setting Window

| Step | SP | Time | PID | ALC | SP W |
|------|--------|------|------|------|------|
| 0 | 100.00 | 0.00 | 0.00 | 0.00 | 0.00 |
| 1 | 115.00 | 0.00 | 0.00 | 0.00 | 0.00 |
| 2 | 115.00 | 0.00 | 0.00 | 0.00 | 0.00 |
| 3 | 115.00 | 0.00 | 0.00 | 0.00 | 0.00 |
| 4 | 115.00 | 0.00 | 0.00 | 0.00 | 0.00 |
| 5 | 115.00 | 0.00 | 0.00 | 0.00 | 0.00 |
| 6 | 115.00 | 0.00 | 0.00 | 0.00 | 0.00 |
| 7 | 115.00 | 0.00 | 0.00 | 0.00 | 0.00 |
| 8 | 115.00 | 0.00 | 0.00 | 0.00 | 0.00 |
| 9 | 115.00 | 0.00 | 0.00 | 0.00 | 0.00 |
| 10 | 115.00 | 0.00 | 0.00 | 0.00 | 0.00 |

New Program Setting Window

Utility Software

Face Plate Auto-Builder for NS

Engineering steps can be drastically reduced by combining a Loop Controller with an NS-series Programmable Terminal (PT).

- Automatically Generate Control and Tuning Windows The software generates NS touch panel screen data from tag information created on the CX-Process Tool (tag names, tag comments, scaling, I/O allocations, etc.).
- There is no need for troublesome communications address settings on the PT or ladder programming.
- The generated data can be edited on the CX-Designer (NS screen creation software) as required. (Some screens cannot be edited.)

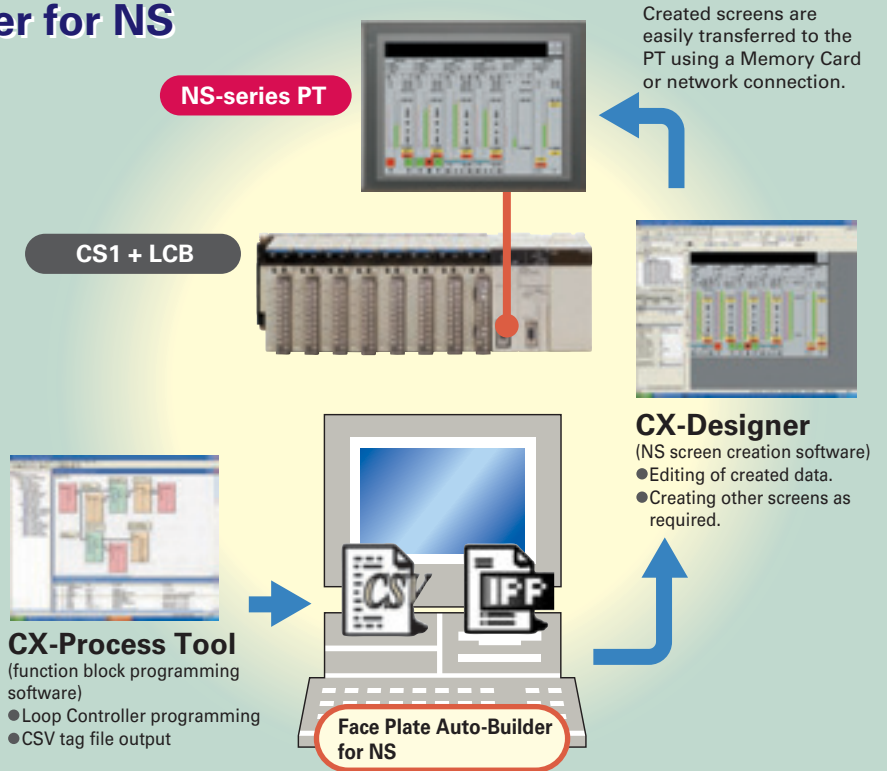

System Configuration

Mounting Position

Loop Control Boards/Units

CS1W-LCB01/05(-GTC)

The CS1W-LCB01/05(-GTC) Loop Control Board is an Inner Board for CS-series CPU Units. Only one Loop Control Board can be mounted to a CS1□-CPU□□H or CS1D-CPU□□S/SA CPU Unit.

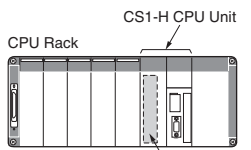

The Loop Control Board is mounted in the Inner Board slot.

CS1D-CPU6□P

The LCB05D Duplex Loop Control Board is mounted in the Inner Board slot of the CS1D-CPU6□H and cannot be removed.

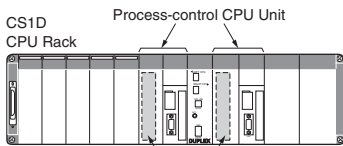

One Loop Control Board is mounted in each of the Inner Board slots (and cannot be removed).

Process Analog I/O Units

Process Analog I/O Units are classified as CS-series Special I/O Units and are mounted to the CPU Rack or a CS-series Expansion Rack. The number of Units that can be mounted to a single Rack (CPU Rack or Expansion Rack) depends on the maximum supply current of the Power Supply Unit and the current consumption of other Units mounted to the Rack. Process Analog I/O Units can be mounted in any position on the Racks.

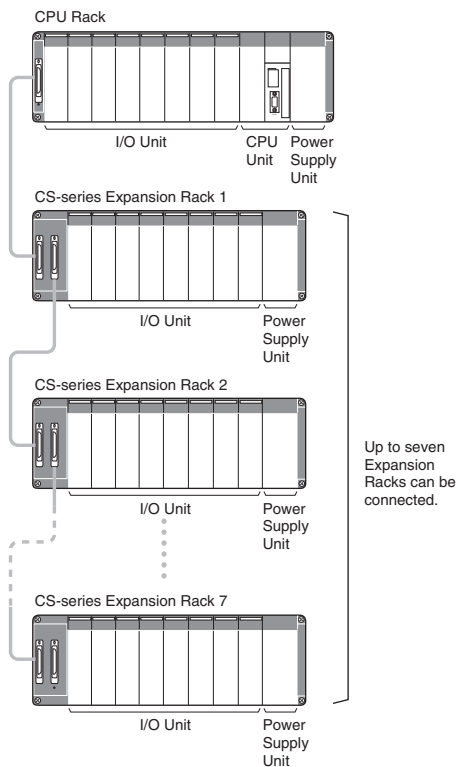

PLC-based Process Control Configuration Example

The process control system is configured using Loop Control Boards, Process Analog I/O Units, and Analog I/O Units to control the functions of the peripheral instruments.

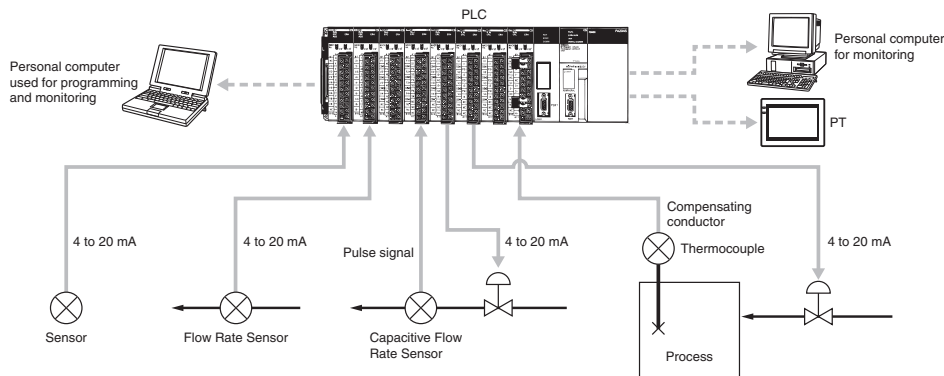

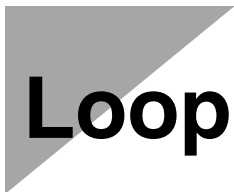

Loop Control Boards

General Specifications

| Item | | Specification | |
|---|------------|---|--|
| Name | | Loop Control Boards | |
| Unit classification | | CS-series Inner Boards | |
| Model number | | CS1W-LCB01: Standard Inner Board | CS1W-LCB05(-GTC): Special Inner Board |
| | | | LCB05D: Duplex Inner Board |
| Applicable CPU Units | | CS1G/H-CPU□□H CS1D-CPU□□S/SA (See note 1.) | CS1G/H-CPU□□H CS1D-CPU□□S/SA (See note 1.) |
| | | | Built into the CS1D-CPU6□P. |
| Mounting location | | Inner Board slot in CPU Unit | |
| Number of Boards/ Units | | 1 Board max. per CPU Unit | |
| Data ex- change with CPU Unit | I/O memory | User Link Tables: ITEM data for function blocks can be allocated in any part of I/O memory (CIO, WR, HR, or DM Areas, or EM Area bank 0). | |
| | All data | HMI function used to allocate function block ITEM data for Control, Operation, and External Controller blocks in the specified bank of the EM Area in the CPU Unit. (Default: Bank 0) | |
| Setting switches | | None | |
| Indicators | | 3 LEDs: RUN, ready, and communications port send/receive | |
| Front panel connections | | RS-232C port x 1 (The CS1D-LCB05D cannot be used to connect to the ES100X Controller.) | |
| Data backup | | By super capacitor: All function block data (including sequence tables and step ladder instructions) | |
| Battery/capacitor life | | 24 hours at 25°C (life shortened by use at higher temperatures) | |
| Data storage in flash memory | | Function block data (RAM data backup and recovery can be performed whenever necessary.) Error log data | |
| Effect on CPU Unit cycle time | | 0.8 ms max. | 25 ms max. (See note 2.) |
| Current consumption (supplied from Power Supply Unit) | | 220 mA at 5 V DC (Increased by 150 mA when NT-AL001-E Link Adapter is used.) | |
| Dimensions | | 34.5 × 130 × 100.5 mm (W × H × D) | |
| Weight | | 100g max. | |
| Standard accessories | | None | |

Note: 1. A Loop Control Board Unit Ver. 1.5 or later is required for use. Do not use a Loop Control Board with a unit version earlier than 1.5.
 2. During duplex initialization: 2.1 s max.

Function Specifications

| Item | | Specification | | | |
|--|---------------------------|---|--|---|--|
| Model numbers | | CS1W-LCB01 | CS1W-LCB05(-GTC) LCB05D (Built into the CS1D-CPU6□P.) | | |
| Operation method | | Function block method | | | |
| Operation cycle | | Settable cycles: 0.01, 0.02, 0.05, 0.1, 0.2, 0.5, 1, or 2 s (default: 1 s) (See note 1.) Can be set for each function block. | | | |
| Number of function blocks | Analog operation | Control blocks (See note 2.) | 50 blocks max. | 500 blocks max. | |
| | | Operation blocks (See note 3.) | | | |
| | | External controller blocks | 32 blocks max. (LCB05D not included). | | |
| | Sequence control | Sequence tables | None | 200 tables max. 32 conditions and 32 actions per table max. (expandable to 64 conditions and 64 actions per table) 6,400 rules total max. | |
| | | Step ladder program blocks | 20 blocks max. 2,000 commands total 100 commands max. per block Separable into a 100 steps max. | 200 blocks max. 4,000 commands total 100 commands max. per block Separable into a 100 steps max. | |
| | I/O blocks | Field terminal blocks | 80 blocks max | | |
| | | User link tables | 2,400 data items max. | | |
| | | All data | HMI functions Allocated 1 EM Area bank | | |
| | | CPU terminal blocks | None | | |
| | | Node terminal blocks | None | | |
| System common blocks | | 1 block max. | | | |
| Method for creating and transferring function blocks | | Created and transferred using CX-Process Tool (included in CX-One Package). | | | |
| Control methods | PID control method | PID with 2 degrees of freedom (with auto-tuning) | | | |
| | Control combinations | Any of the following function blocks can be combined: Basic PID control, cascade control, feed-forward control, sample PI control, Smith dead time compensation control, PID control with differential gap, override control, program control, time-proportional control, etc. | | | |
| Alarms | PID block internal alarms | 4 PV alarms (upper upper-limit, upper limit, lower limit, lower lower-limit) and 1 deviation alarm per PID block | | | |
| | Alarm blocks | High/low alarm blocks, deviation alarm blocks | | | |

- Note:**
1. Operation cycles of 0.01, 0.02, and 0.05 s cannot be set for the LCB05D.
 2. Control blocks such as those for PID control.
 3. Operation blocks for process control such as those for alarms, square roots, time/date calculations, and pulse-train computations.



CX-Process Tool and Monitor

Software Specifications

| Item | | CX-Process Tool |
|-----------------------|--|--|
| Name | | CX-Process Tool (Included in CX-One Package) |
| Model number | | CXONE-AL□□D-V□ |
| Applicable PLCs | | CS/CJ-series PLCs |
| Applicable Units | | CJ-series Loop-control CPU Units CS-series Loop Control Boards CS1D Process-control CPU Units |
| Compatible computers | OS | Windows 7 (32-bit/64-bit version) / Windows 8 (32-bit/64-bit version) / Windows 8.1 (32-bit/64-bit version)// Windows 10 (32-bit/64-bit version) |
| | CPU (See note2.) | Processor recommended by Microsoft. |
| | Memory | Memory recommended by Microsoft. |
| | Hard disk storage | Minimum: 350 Mbytes free space (Including approximately 280 Mbytes used for communications middleware and other purposes) |
| | Monitor | Minimum: XGA Recommended: SXGA 65,536 colors or more |
| Communications method | Connection with CPU Unit (or Serial Communications Board/Unit) | When FinsGateway Serial Unit driver is used: Communications protocol with PLC: Host Link or Peripheral Bus (See note 3.) • Connect the computer to the peripheral port or built-in RS-232C port of the CPU Unit, or to the RS-232C port of the Serial Communications Board/Unit. • Connecting cable: For connecting to peripheral port of CPU Unit: CS1W-CN□□□ (2 m or 6 m) For connecting to RS-232C port of CPU Unit: XW2Z-□□□-□ (2 m or 5 m) |
| | | When CX-Server is used: Communications protocol with PLC: Host Link or Peripheral Bus Connecting cable: • For connecting to peripheral port of CPU Unit: CS1W-CN□□□ (2 m or 6 m) For connecting to RS-232C port of CPU Unit: XW2Z-□□□-□ (2 m or 5 m) |
| | Connection via Controller Link | When FinsGateway Controller Link driver or CX-Server is used: Install the software in a computer with a Controller Link Support Board to communicate with a PLC with a Controller Link Unit mounted. |
| | Connection via Ethernet | When FinsGateway ETN_UNIT driver or CX-Server is used: Install the software in a computer with an Ethernet Board to communicate with a PLC with an Ethernet Unit mounted. |

CX-Process Tool and Monitor

| Item | Specifications |
|-------------------|---|
| | CX-Process Tool |
| Offline functions | <ul style="list-style-type: none"> • ITEM data settings for function blocks • Software connections for analog signals • Displaying and printing text strings (annotation) pasted on function block diagrams and ladder diagrams. • Instructions for step ladder blocks and commands for sequence table blocks • Tag settings for CX-Process Monitor • Engineering unit display setting • Segment Program parameter setting |
| Online functions | <ul style="list-style-type: none"> • Transfer of function block data (Downloading/Uploading for Loop Control Boards.) • Starting/stopping all function blocks (LCB) • Monitoring system operation: Monitoring and controlling the System Common block (including LCB load rates) • Validating LCB operation: Checking function block connections (including starting and starting individual function blocks), validating ladder diagrams and sequence tables, and monitoring ITEMS • Tuning PID constants and other parameters (fine tuning and autotuning) • Initialization of Loop Control Unit memory (RAM) • External backup specifications |

Note: 1. The CX-Process Tool functions that can be used depend on the version. For details, refer to the *operation manuals* (Cat. No.: W372-E1-□ and W373-E1-□).

2. CX-One Operating System Precaution:

1) System requirements and hard disk space may vary with the system environment.

3. Peripheral Bus cannot be used when FinsGateway V3 is used.

Function Blocks (Unit Ver. 3.5)

System Common Blocks

| Type | Block Name | Function |
|--------|---------------|--|
| System | System Common | Makes settings common to all function blocks and outputs signals for the system. |

Control Blocks

| Type | Block Name | Function |
|------------|--|--|
| Controller | 2-position ON/OFF (See note 1.) | 2-position type ON/OFF controller |
| | 3-position ON/OFF (See note 1.) | 3-position type ON/OFF controller for heating/cooling ON/OFF control |
| | Basic PID (See note 1.) | Performs basic PID control. |
| | Advanced PID (See note 1.) | Performs PID with two degrees of freedom control for enabling deviation/MV compensation, MV tracking, etc. |
| | Blended PID (See note 2.) | Performs PID control on the cumulative value (cumulative deviation) between the accumulated value PV and accumulated value Remote Set Point. |
| | Batch Flowrate Capture (See note 2.) | Functions to open the valve at a fixed opening until a fixed batch accumulated value is reached. |
| | Fuzzy Logic (See note 2.) | Outputs up to two analog outputs based on fuzzy logic performed on up to 8 analog inputs. |
| | Indication and Setting (See note 1.) | Manual setter with PV indication and SP setting functions |
| | Indication and Operation (See note 1.) | Manual setter with PV indication and MV setting functions |
| | Ratio Setting (See note 1.) | Ratio and bias setter with PV indication and ratio setting function |
| | Indicator (See note 1.) | PV indicator with PV alarm |

Note: 1. High-speed control of function blocks is supported (the operation cycle can be set to 0.01 s, 0.02 s, or 0.05 s), except when using the LCB05D.

2. Cannot be used with the CS1W-LCB05-GTC.

External Controller Blocks

| Type | Block Name | Function |
|---------------------------|--|---|
| External Controller Block | ES100X Controller Terminal (See note.) | Performs monitoring and setting for an ES100X Controller connected directly to the RS-232C port on the Loop Control Unit. |

Note: LCB05D not supported.

Operation Blocks

| Type | Block Name | Function |
|---------------------------------|---|--|
| Alarm/ Signal restrictions/Hold | 4-Point Warning Indicator | Provides the alarm contact outputs for the high/high, high, low, and low/low limits of single analog signals. This function block provides the same function as the Indicator block (model 034). |
| | High/Low Alarm (See note 1.) | Provides the alarm contact outputs for the high and low limits of single analog signals. |
| | Deviation Alarm (See note 1.) | Provides the alarm contact outputs for the deviation of two analog signals. |
| | Rate-of-change Operation and Alarm (See note 1.) | Provides the alarm contact outputs for the high and low limits of rate-of-change operation when the analog signal rate-of-change is output. |
| | High/Low Limit (See note 1.) | Limits the high and low limits of single analog signals. |
| | Deviation Limit (See note 1.) | Calculates the deviation between two analog signals, and limits the deviation within that range. |
| | Analog Signal Hold (See note 1.) | Holds the maximum, minimum or instantaneous value of single analog signals. |
| Arithmetic | Addition or Subtraction (See note 1.) | Performs addition/subtraction with gain and bias on up to 4 analog signals. |
| | Multiplication (See note 1.) | Performs multiplication with gain and bias on up to 2 analog signals. |
| | Division (See note 1.) | Performs division with gain and bias on up to 2 analog signals. |
| | Range Conversion (See note 1.) | Easily converts up to 8 analog signals simply by inputting the 0% and 100% input values and 0% and 100% output values. |
| | Arithmetic Operation (See note 1.) | Performs various math operation (trigonometric, logarithmic, etc.) on floating-point decimal values converted (to industrial units) from up to 8 analog inputs. |
| Functions | Square Root (See note 1.) | Performs square root extraction (with low-end cutout) on single analog signals. |
| | Absolute Value (See note 1.) | Outputs the absolute value of single analog signals. |
| | Non-linear Gain (Dead Band) (See note 1.) | Performs non-linear (3 gain values) operation on single analog signals. Analog signals can also set as a dead band (with different gap). |
| | Low-end Cutout (See note 1.) | Sets output to zero close to the zero point of single analog signals. |
| | Segment Linearizer (See note 1.) | Converts single analog signals to 15 segments before the signals is output. |
| | Temperature And Pressure Correction (See note 1.) | Performs temperature and pressure correction. |
| Time Function | First-order Lag (See note 1.) | Performs first-order lag operation on single analog signals. |
| | Rate-of-change Limit (See note 1.) | Performs rate-of-change restriction on single analog signals. |
| | Moving Average (See note 1.) | Performs moving average operation on single analog signals. |
| | Lead/Delay (See note 1.) | Performs lead/delay operation on single analog signals. |
| | Dead Time (See note 1.) | Performs dead time and first-order lag operations on single analog signals. |
| | Dead Time Compensation | Used for Smith's dead time compensation PID control |
| | Accumulator for Instantaneous Value Input | Accumulates analog signals, and outputs 8-digit accumulated value signals. |
| | Run Time Accumulator | Accumulates the operating time, and outputs the pulse signal per specified time. |
| | Time Sequence Data Statistics (See note 1.) | Records time sequence data from analog signals and calculates statistics, such as averages and standard deviations. |
| | Ramp Program | Ramp program setter for combining ramps for time and hold values. |
| | Segment Program | Segment program setter setting the output values with respect to time. |
| | Segment Program 2 | Segment program setting with wait function for setting the output values with respect to time |
| | Segment Program 3 (See note 4.) | |
| Signal Selection/ Switching | Rank Selector (See note 1.) | Selects the rank of up to 8 analog signals. |
| | Input Selector (See note 1.) | Selects the specified analog signals specified by the contact signal from up to 8 analog signals. |
| | 3-input Selector (See note 1.) | Selects and outputs one of three analog input signals. |

Function Blocks (Unit Ver. 3.5)

| Type | Block Name | Function |
|--------------------------------|--|---|
| Signal Selection/ Switching | 3-output Selector (See note 1.) | Outputs one analog input signal in one of three switched directions. |
| | Constant Selector (See note 1.) | Selects 8 preset constants by the contact signal. |
| | Constant Generator (See note 1.) | Outputs 8 independent constants. |
| | Ramped Switch | Switches two analog inputs (or constants) with a ramp. |
| | Bank Selector (See note 3.) | Stores a maximum of eight sets of PID parameters (SP, P, I, D, MH, ML) in advance, and switches them to basic PID, advanced PID, or blended PID parameters in response to the analog input zone or input bit. |
| | Split Converter (See note 3.) | Takes an operating amount input from a basic PID or advanced PID block and converts the V characteristics or parallel characteristics into two analog outputs (e.g., heating and cooling operating amounts). |
| ITEM Settings | Constant ITEM Setting (See note 1.) | Writes the constant to the specified ITEM at the rising edge of the send command contact. |
| | Variable ITEM Setting (See note 1.) | Writes the analog signal to the specified ITEM at the rising edge of the send command contact. |
| | Batch Data Collector (See note 1.) | Stores each of max. 8 analog inputs to buffer by a certain timing within sequential processing. |
| Pulse Train Operation | Accumulated Value Input Adder | Adds up to four accumulated value signals. |
| | Accumulated Value Analog Multiplier | Multiplies analog signals by the accumulated value signals. |
| | Accumulator for Accumulated Value Input | Converts 4-digit accumulated value signals to 8 digits. |
| | Contact input/Accumulated Value Output | Counts low-speed contact pulses, and outputs 8-digit accumulated signals. |
| | Accumulated Value Input/Contact Output | Converts 4-digit accumulated value signals to low-speed contact pulses before they are output. |
| Others | Analog/Pulse Width Converter (See note 1.) | Changes the ON/OFF duration ratio in a constant cycle duration so that it is proportional to the analog signal. |
| Sequence Operation | Contact Distributor | Connect contact signals between function blocks in a 1:1 connection. |
| | Constant Comparator (See note 1.) | Compares up to eight sets of analog signals and constants, and outputs the comparison results as contacts. |
| | Variable Comparator (See note 1.) | Compares up to eight pairs of analog signals, and outputs the comparison results as contacts. |
| | Timer (See note 1.) | 2-stage output type addition timer for forecast values and reached values. Can also output the present value. |
| | ON/OFF Timer (See note 1.) | Timer for performing ON-OFF operation at preset ON and OFF times. |
| | Clock Pulse (See note 1.) | Manipulates and monitors ON/OFF valves with open/close limit switches. |
| | Counter (See note 1.) | 2-stage output type addition timer for forecast values and arrival values. Can also output the current value. |
| | Internal Switch (See note 1.) | Temporary storage contact for accepting relays in the Step Ladder Program block. (Note: One internal switch is already allocated as "temporary storage" in CX-Process Tool.) |
| | Level Check (See note 1.) | Checks an analog input for 8 levels and outputs a contact corresponding to the level. The level number is also output as an analog value. |
| Contact Type Control Target | ON/OFF Valve Manipulator | Manipulates and monitors ON/OFF valves with open/close limit switches. |
| | Motor Manipulator | Manipulates and monitors motor operation. |
| | Reversible Motor Manipulator | Manipulates and monitors reversible motor operation. |
| | Motor Opening Manipulator | Inputs a target opening, and manipulates an electric positional-proportional motor. |
| | Switch Meter (See note 2.) | Manipulates and monitors multiple (up to 8) devices such as ON/OFF valves, motors, or pumps. |

- Note:**
1. High-speed control of function blocks is supported (the operation cycle can be set to 0.01 s, 0.02 s, or 0.05 s), except when using the LCB05D.
 2. Cannot be used with the CS1W-LCB05-GTC.
 3. LCB05D not supported.
 4. Supported by the CS1W-LCB01/05 only.

Sequence Control Blocks

| Type | Block Name | Function |
|------------------|------------------------------------|--|
| Sequence Control | Step Ladder Program (See note.) | Performs logic sequence and step progression control. |
| | Sequence Table (See note.) | Performs logic sequence and step progression control based on conditions and actions listed in tabular form. |

Note: High-speed control of function blocks is supported (the operation cycle can be set to 0.01 s, 0.02 s, or 0.05 s), except when using the CS1D-LCB05D.

Field Terminal Blocks

| Type | Block Name | Function |
|-------------|---|---|
| Contact I/O | DI 8-point Terminal (See note.) | Inputs 8 contacts from 8-point Input Unit. |
| | DI 16-point Terminal (See note.) | Inputs 16 contacts from 16-point Input Unit. |
| | DI 32-point Terminal (See note.) | Inputs 32 contacts from 32-point Input Unit. |
| | DI 64-point Terminal (See note.) | Inputs 64 contacts from 64-point Input Unit. |
| | DO 5-point Terminal (See note.) | Outputs 5 contacts from 5-point Output Unit. |
| | DO 8-point Terminal (See note.) | Outputs 8 contacts from 8-point Output Unit. |
| | DO12-point Terminal (See note.) | Outputs 12 contacts from 12-point Output Unit. |
| | DO16-point Terminal (See note.) | Outputs 16 contacts from 16-point Output Unit. |
| | DO32-point Terminal (See note.) | Outputs 32 contacts from 32-point Output Unit. |
| | DO64-point Terminal (See note.) | Outputs 64 contacts from 64-point Output Unit. |
| | DI 16-point/DO 16-point Terminal (See note.) | Inputs and outputs 16 contacts each from 16-point Input/16-point Output Units. |
| | DI 96-point Terminal (See note.) | Inputs 96 contacts from 96-contact Input Units. |
| | DO 96-point Terminal (See note.) | Outputs 96 contacts from 96-contact Output Units. |
| | DI 48-point/DO 48-point Terminal (See note.) | Inputs and outputs 48 contacts each from 48-point Input/48-point Output Units. |
| Analog I/O | AI 8-point Terminal (AD003) (See note.) | Inputs 8 analog signals from the C200H-AD003*. |
| | AO 8-point Terminal (DA003/4) (See note.) | Outputs 8 analog signals from the C200H-DA003/DA004*. |
| | AI 2-point/AO 2-point Terminal (MAD01) (See note.) | Inputs and outputs 2 analog signals each from the C200H-MAD01*. |
| | AI 4-point Terminal (PTS01-V1/02/03, PDC01, PTW01) (See note.) | Inputs 4 analog signals from one of CS1W-PTS01-V1 (Isolated-type Thermocouple Input Unit), CS1W-PTS02/03 (Isolated-type Temperature-resistance Thermometer Input Unit), CS1W-PDC01 (Isolated-type Analog Input Unit) or CS1W-PTW01 (2-lead Transmitter Input Unit). |
| | PI 4-point Terminal (PPS01) (See note.) | Inputs 4 instantaneous values and accumulated values each from CS1W-PPS01 (Isolated-type Pulse Input Unit). |
| | AO 4-point Terminal (PMV01) (See note.) | Outputs 4 analog signals from CS1W-PMV01 (Isolated-type Control Output Unit). |
| | AI 8-point Terminal (PTR01/02) (See note.) | Inputs 8 analog signals from CS1W-PTR01 (Power Transducer Input Unit) or CS1W-PTR02 (Analog Input Unit (100 mV)). |
| | AO 4-point Terminal (PMV02) (See note.) | Outputs 4 analog signals from CS1W-PMV02 (Isolated-type Control Output Unit). |
| | AI 4-point Terminal (PTS51) (See note.) | Inputs 4 analog signals from CS1W-PTS51 or CJ1W-PTS51 (isolated-type thermocouple Input Unit). |
| | AI 4-point Terminal (PTS52) (See note.) | Inputs 4 analog signals from CS1W-PTS52 or CJ1W-PTS52 (isolated-type thermocouple input Unit). |

Function Blocks (Unit Ver. 3.5)

Node Terminal Blocks

| Type | Block Name | Function |
|------------|--|--|
| Analog I/O | AI 8-point Terminal (PTS55) (See note.) | Inputs 8 analog signals from CS1W-PTS55 (isolated-type thermocouple Input Unit). |
| | AI 8-point Terminal (PTS56) (See note.) | Inputs 8 analog signals from CS1W-PTS56 (isolated-type thermocouple Input Unit). |
| | AI 8-point Terminal (PDC55) (See note.) | Inputs 8 analog signals from CS1W-PDC55 (Direct current Input Unit). |
| | AI 4-point/AO 4-point Terminal (MAD44) (See note.) | Inputs and outputs 4 analog signals each from the CS1W-MAD44. |
| | AI 16-point Terminal (AD161) (See note.) | Inputs 16 analog signals from CS1W-AD161. |
| | AI 8-point Terminal (AD081) (See note.) | Inputs 8 analog signals from the CS1W-AD081(-V1) or CJ1W-AD081(-V1). |
| | AO 8-point Terminal (DA08V/C) (See note.) | Outputs 8 analog signals from the CS1W-DA08V/C or CJ1W-DA08V/C. |
| | AI 4-point Terminal (AD041) (See note.) | Inputs 4 analog signals from the CS1W-AD041(-V1) or CJ1W-AD041(-V1). |
| | AO 4-point Terminal (DA041) (See note.) | Outputs 4 analog signals from the CS1W-DA041 or CJ1W-DA041. |
| | AI 4-point Terminal (DRT1-AD04) (See note.) | Inputs four analog signals from a DRT1-AD04 DeviceNet Slave Analog Input Unit. |
| | AO 2-point Terminal (DRT1-DA02) (See note.) | Outputs two analog signals from a DRT1-DA02 DeviceNet Slave Analog Output Unit. |

Note: High-speed control of function blocks is supported (the operation cycle can be set to 0.01 s, 0.02 s, or 0.05 s), except when using the LCB05D.

* Product no longer available to order.

Node Terminal Blocks

| Type | Block Name | Function |
|------------------------|------------------------------------|--|
| Send to Computer | DO to Computer | Sends 128 contacts to the send-to-computer area. When CX-Process Monitor is used, the contact signals to be monitored are connected to this function block. |
| | AO to Computer | Sends 16 analog values to the send-to-computer area. When CX-Process Monitor is used, the analog signals to be monitored are connected to this function block. |
| | 1-Block Send Terminal to Computer | Sends a specified 1 block to the send-to-computer area. When CX-Process Monitor is used, the 1 block to be monitored are connected to this function block. |
| | 4-Block Send Terminal to Computer | Sends a specified 4 block to the send-to-computer area. When CX-Process Monitor is used, the 4 block to be monitored are connected to this function block. |
| Send to All Nodes | DO Terminal to All Nodes | Sends 32 contacts to nodes on the Controller Link Data Link. |
| | AO Terminal to All Nodes | Sends 2 analog values to nodes on the Controller Link Data Link. |
| | DO Terminal Settings from Computer | Receives 32 contacts sent from the computer. (Can also be downloaded to the send-to-all nodes area.) |
| | AO Terminal Settings from Computer | Receives 2 analog values sent from the computer. (Can also be downloaded to the send-to-all nodes area.) |
| Receive from All Nodes | DI Terminal from All Nodes | Receives 32 contacts sent from nodes on the Controller Link Data Link. |
| | AI Terminal from All Nodes | Receives 2 analog values sent from nodes on the Controller Link Data Link. |

CPU Unit Terminal Blocks

| Type | Block Name | Function |
|--------------------|---------------------------|--|
| CPU Unit Terminals | DI Terminal from CPU Unit | Inputs max. 128 points from any leading address in CPU Unit I/O memory (one of CIO, WR, HR, DM and EM area types). (read) |
| | DO Terminal to CPU Unit | Outputs max. 128 points from any leading address in CPU Unit I/O memory (one of CIO, WR, HR, DM and EM area types). (read and write) |
| | AI Terminal from CPU Unit | Inputs max. 8 words from any leading address in CPU Unit I/O memory (one of CIO, WR, HR, DM and EM area types). (read) |
| | AO Terminal to CPU Unit | Outputs max. 8 words from any leading address in CPU Unit I/O memory (one of CIO, WR, HR, DM and EM area types). (read and write) |

SCADA Interface Blocks

| Type | Block Name | Function |
|-----------------------------|------------------------------------|---|
| Expanded CPU Unit Terminals | Expanded DI Terminal from CPU Unit | Inputs any contact data in CPU Unit I/O Memory, and writes max. 64 points on another function block. |
| | Expanded DO Terminal from CPU Unit | Inputs the contact data of another function block, and writes max. 64 points on any I/O Memory in the CPU Unit. |
| | Expanded AI Terminal from CPU Unit | Inputs any analog data in CPU Unit I/O Memory, and writes max. 64 words on another function block. |
| | Expanded AO Terminal from CPU Unit | Inputs the analog data of another function block, and writes max. 64 words on any CPU Unit I/O Memory. |
| Send/Receive All Blocks | Receive All Blocks | Reads ITEM data specified for Send/Receive All Blocks for up to 32 Control Blocks, 249 Operation Blocks, and 32 External Controller Blocks starting from a specified address in the I/O memory of the CPU Unit. |
| | Send All Blocks | Writes ITEM data specified for Send/Receive All Blocks for up to 32 Control Blocks, 249 Operation Blocks, and 32 External Controller Blocks starting to a specified address in the I/O memory of the CPU Unit. |

Note: The CS1□-LCB□□□ supports User Link Tables and an HMI instead.

Process and Analog I/O Units

Process and Analog I/O Units

Overview

A wide range of 25 I/O Units, including 16 Isolated-type Units, covers almost all typical applications. Also featuring high-speed (10 ms) and high-resolution (1/64,000) types, this line-up meets a diverse array of potential uses, from data logging to high-speed measurement control.

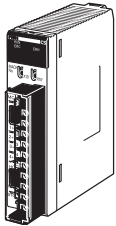

CS1W-PTS11

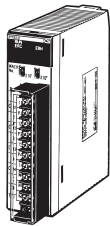

CS1W-PTS12

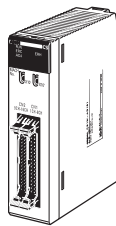

CS1W-AD161

Features

- Dramatic reductions in installation cost, space, and set-up steps are attained by eliminating the need for external setters and converters.
- Process value alarms and rate-of-change calculations can be executed from temperature and analog inputs.
- Rate-of-change limits and high/low output limits calculated for analog output.
- Peak/bottom hold and top/valley hold functions can be used for process values (CS1W-P□□1□ only).
- Zero point and span can be adjusted for any specified range, and adjustment days and times can be automatically saved. The adjustment deadline and adjustment deadline expiration notice can also be set and notification given (CS1W-P□□1□ only).
- Changes exceeding a set threshold can be counted, and analog input values can be integrated (CS1W-P□□1□ only).
- Reduced wiring with MIL connectors (CS1W-AD161 only). XW2D-34G6 Connector-Terminal Block Conversion Unit can be used.

Overview of Process Analog I/O Units

| Name | Model | Number of I/O | I/O type | Main specifications (See note.) | Main functions |
|---|---------------|---------------|--|--|--|
| Isolated-type Thermocouple Input Unit (high-resolution) | CS1W-PTS11 | 4 inputs | B, E, J, K, L, N, R, S, T, U, WRe5-26, PLII, ±100 mV | Standard accuracy: ±0.05% of F.S. Temperature coefficient: ±0.01%/°C Resolution: 1/64,000 Conversion period: 20 ms/4 pts, 10 ms/2 pts | Output scaling (±32,000) Process value alarms (HH, H, L, LL) Rate-of-change calculation and alarm Input disconnection alarm Top/bottom/valley hold Zero/span adjustment for any specified range |
| Isolated-type Resistance Thermometer Input Unit (high-resolution) | CS1W-PTS12 | 4 inputs | Pt100 Ω (JIS, IEC), JPt100 Ω, Pt50 Ω, Ni508.4 Ω | Standard accuracy: ±0.05% of F.S. or ±0.1°C, whichever is larger Temperature coefficient: ±0.009%/°C Resolution: 1/64,000 Conversion period: 20 ms/4 pts, 10 ms/2 pts | Output scaling (±32,000) Process value alarms (HH, H, L, LL) Rate-of-change calculation and alarm Input disconnection alarm Top/bottom/valley hold Zero/span adjustment for any specified range |
| Isolated-type DC Input Unit (high-resolution) | CS1W-PDC11 | 4 inputs | 4 to 20 mA, 0 to 20 mA, 0 to 10 V, ±10 V, 0 to 5 V, ±5 V, 1 to 5 V, 0 to 1.25 V, ±1.25 V | Standard accuracy: ±0.05% of F.S. Temperature coefficient: ±0.008%/°C Resolution: 1/64,000 Conversion period: 20 ms/4 pts, 10 ms/2 pts | Output scaling (±32,000) Process value alarms (HH, H, L, LL) Rate-of-change calculation and alarm Input disconnection alarm Top/bottom/valley hold Zero/span adjustment for any specified range |
| Isolated-type Thermocouple Input Unit (economical type) | CS1W-PTS51 | 4 inputs | R, S, K, J, T, L, B | Centigrade Selected Total accuracy: ±0.3% of PV or ±1°C whichever is larger, ±1 digit max. Conversion period: 250 ms/Unit | Process value alarms (H, L) Input disconnection detection |
| | CS1W-PTS55 | 8 inputs | | | |
| Isolated-type Resistance Thermometer Input Unit (economical type) | CS1W-PTS52 | 4 inputs | Pt100(JIS, IEC), JPt100 | Centigrade Selected Total accuracy: ±0.3% of PV or ±0.8°C, whichever larger, ±1 digit max. Conversion period: 250 ms/Unit | Process value alarms (H, L) Input disconnection detection |
| | CS1W-PTS56 | 8 inputs | | | |
| Isolated-type DC Input Unit (economical type) | CS1W-PDC55 | 8 inputs | 4 to 20 mA, 0 to 10 V, 0 to 5 V, 1 to 5 V | Standard accuracy: ±0.3% of F.S. Resolution: 1/16,000 Conversion period: 250 ms/8 inputs | Process value alarms (H, L) Input disconnection alarm |
| Isolated-type Thermocouple Input Unit | CS1W-PTS01-V1 | 4 inputs | B, E, J, K, N, R, S, T Variable range: ±80 mV DC | Standard accuracy: ±0.1% Temp. coefficient: ±0.015%/°C Resolution: 1/4,096 Conversion cycle: 150 ms/4 pts | Variable range setting Scaling (±32,000) Process value alarms (HH, H, L, LL) Rate-of-change calculation and alarm Input disconnection detection |
| Isolated-type Resistance Thermometer Input Unit | CS1W-PTS02 | 4 inputs | Pt100 (JIS, IEC), JPt100 | Standard accuracy: ±0.1% or ±0.1°C, whichever is larger Temperature coefficient: ±0.015%/°C Resolution: 1/4,096 Conversion period: 100 ms/4 pts | Variable range setting Output scaling (±32,000) Process value alarms (HH, H, L, LL) Rate-of-change calculation and alarm Input disconnection alarm |
| Isolated-type Resistance Thermometer Input Unit (Ni508.4 Ω) | CS1W-PTS03 | 4 inputs | Ni508.4 Ω | Standard accuracy: ±0.2% or ±0.2°C, whichever is larger Temperature coefficient: ±0.015%/°C Resolution: 1/4,096 Conversion period: 100 ms/4 pts | Variable range setting Output scaling (±32,000) Process value alarms (HH, H, L, LL) Rate-of-change calculation and alarm Input disconnection detection |

Process and Analog I/O Units

Overview of Process Analog I/O Units

| Name | Model | Number of I/O | I/O type | Main specifications (See note.) | Main functions |
|---|------------|---------------|---|--|--|
| Isolated-type 2-Wire Transmitter Input Unit | CS1W-PTW01 | 4 inputs | 4 to 20 mA, 1 to 5 V | Standard accuracy: $\pm 0.2\%$ Temp. coefficient: $\pm 0.015\%/^{\circ}\text{C}$ Resolution: 1/4,096 Conversion period: 100 ms/4 pts | Built-in power supply for 2-wire transmitter Output scaling ($\pm 32,000$) Process value alarms (HH, H, L, LL) Rate-of-change calculation and alarm Square root Input error detection |
| Isolated-type Analog Input Unit | CS1W-PDC01 | 4 inputs | -10 to 10 V, 0 to 10 V, -5 to 5 V, 0 to 5 V, 1 to 5 V, ± 10 V DC variable range, 4 to 20 mA, 0 to 20 mA | Standard accuracy: $\pm 0.1\%$ Temp. coefficient: $\pm 0.015\%/^{\circ}\text{C}$ Resolution: 1/4,096 Conversion cycle: 100 ms/4 pts | Process value alarms (HH, H, L, LL) Output scaling ($\pm 32,000$) Square root Rate-of-change calculation and alarm Input error detection |
| Isolated-type Pulse Input Unit | CS1W-PPS01 | 4 inputs | Max. counting speed: 20 k pulses/s (voltage input or no-voltage semiconductor input) 20 pulses/s (contact input) | --- | Built-in sensor power supply Contact bounce filter Unit pulse conversion Accumulated value output Instantaneous value output and 4 instantaneous value alarms |
| Isolated-type Analog Output Unit | CS1W-PMV01 | 4 outputs | 4 to 20 mA, 1 to 5 V | Standard accuracy: $\pm 0.1\%$ (4 to 20 mA) Standard accuracy: $\pm 0.2\%$ (1 to 5 V) Temperature coefficient: $\pm 0.015\%/^{\circ}\text{C}$ 4,000 (outputs) Conversion period: 100 ms/4 pts | Output disconnection alarm Control output answer input Output rate-of-change limit Output high/low limits |
| | CS1W-PMV02 | 4 outputs | 0 to 10 V, ± 10 V, 0 to 5 V, ± 5 V, 0 to 1 V, ± 1 V | Standard accuracy: $\pm 0.1\%$ Temp. coefficient: $\pm 0.015\%/^{\circ}\text{C}$ Resolution (full scale): ± 10 V, ± 1 V: 1/16,000 0 to 10 V, 0 to 1 V, and ± 5 V: 1/8,000 0 to 5 V: 1/4,000 Conversion period: 40 ms/4 pts | Output rate-of-change limit Output high/low limits Output scaling ($\pm 32,000$) |
| Power Transducer Input Unit | CS1W-PTR01 | 8 inputs | ± 1 mA, 0 to 1 mA | Standard accuracy: $\pm 0.2\%$ Temp. coefficient: $\pm 0.015\%/^{\circ}\text{C}$ Resolution: 1/4,096 Conversion cycle: 200 ms/8 pts | Anti-overshooting at motor startup Process value alarms (H, L) Output scaling ($\pm 32,000$) |
| Analog Input Unit (100 mV) | CS1W-PTR02 | 8 inputs | ± 100 mV, 0 to 100 mV | Standard accuracy: $\pm 0.2\%$ Temp. coefficient: $\pm 0.015\%/^{\circ}\text{C}$ Resolution: 1/4,096 Conversion period: 200 ms/8 pts | Process value alarms (H, L) Output scaling ($\pm 32,000$) |

Note: Varies depending on usage conditions. Refer to the *Analog I/O Units User's Manual (W368)* for details.

Overview of Analog I/O Units

| Name | Model | Number of I/O | I/O signal ranges | Overall accuracy |
|--------------------|-----------------------------|-----------------------|--|--|
| Analog Input Unit | CS1W-AD041-V1 | 4 inputs | 1 to 5 V, 0 to 5 V, 0 to 10 V, -10 to 10 V, 4 to 20 mA | Voltage input: $\pm 0.2\%$ of F.S.: current input $\pm 0.4\%$ of F.S. ($23\pm 2^\circ\text{C}$) Voltage input: $\pm 0.4\%$ of F.S.: current input $\pm 0.6\%$ of F.S. (0 to 55°C) Resolution: 1/8,000 (See note 1.) Conversion speed: 250 μs /point max. (See note 1.) (Can be used with a resolution of 1/4,000 and conversion speed of 1 ms.) |
| | CS1W-AD081-V1 | 8 inputs | 1 to 5 V, 0 to 5 V, 0 to 10 V, -10 to 10 V, 4 to 20 mA | Voltage input: $\pm 0.2\%$ of F.S.: current input $\pm 0.4\%$ of F.S. ($23\pm 2^\circ\text{C}$) Voltage input: $\pm 0.4\%$ of F.S.: current input $\pm 0.6\%$ of F.S. (0 to 55°C) Resolution: 1/8,000 (See note 1.) Conversion speed: 250 μs /point max. (See note 1.) (Can be used with a resolution of 1/4,000 and conversion speed of 1 ms.) |
| | CS1W-AD161 (See note 2.) | 16 inputs | 1 to 5 V, 0 to 5 V, 0 to 10 V, -10 to 10 V, 4 to 20 mA | Voltage input: $\pm 0.2\%$ of F.S.: current input $\pm 0.2\%$ of F.S. ($23\pm 2^\circ\text{C}$) Voltage input: $\pm 0.4\%$ of F.S.: current input $\pm 0.4\%$ of F.S. (0 to 55°C) Resolution: 1/8,000 (See note 1.) Conversion speed: 250 μs /point max. (See note 1.) (Can be used with a resolution of 1/4,000 and conversion speed of 1 ms.) |
| Analog Output Unit | CS1W-DA041 | 4 outputs | 1 to 5 V, 0 to 5 V, 0 to 10 V, -10 to 10 V, 4 to 20 mA | Voltage output: $\pm 0.3\%$ of F.S.: current output $\pm 0.5\%$ of F.S. ($23\pm 2^\circ\text{C}$) Voltage output: $\pm 0.5\%$ of F.S.: current output $\pm 0.8\%$ of F.S. (0 to 55°C) Resolution: 1/4,000 Conversion speed: 1 ms/point max. |
| | CS1W-DA08V | 8 outputs | 1 to 5 V, 0 to 5 V, 0 to 10 V, -10 to 10 V | $\pm 0.3\%$ of F.S. ($23\pm 2^\circ\text{C}$) $\pm 0.5\%$ of F.S. (0 to 55°C) Resolution: 1/4,000 Conversion speed: 1 ms/point max. |
| | CS1W-DA08C | 8 outputs | 4 to 20 mA | $\pm 0.5\%$ of F.S. ($23\pm 2^\circ\text{C}$) $\pm 0.8\%$ of F.S. (0 to 55°C) Resolution: 1/4,000 Conversion speed: 1 ms/point max. |
| Analog I/O Unit | CS1W-MAD44 | 4 inputs 4 outputs | Input: 1 to 5 V, 0 to 5 V, 0 to 10 V, -10 to 10 V, 4 to 20 mA Output: 1 to 5 V, 0 to 5 V, 0 to 10 V, -10 to 10 V | Voltage input: $\pm 0.2\%$ of F.S.: current input $\pm 0.4\%$ of F.S. ($23\pm 2^\circ\text{C}$) Voltage input: $\pm 0.4\%$ of F.S.: current input $\pm 0.6\%$ of F.S. (0 to 55°C) Output: $\pm 0.3\%$ of F.S. ($23\pm 2^\circ\text{C}$) Output: $\pm 0.5\%$ of F.S. (0 to 55°C) I/O resolution: 1/4,000 Conversion speed: 1 ms/point max. |

- Note: 1.** The resolution and conversion speed can be switched with a DM setting. If it isn't necessary to change the setting, the Unit can be used with the earlier model's mode (resolution of 1/4,000 and conversion speed of 1 ms) just like the conventional model.
- 2.** Use the OMRON XW2D-34G6 Connector-Terminal Block Conversion Unit and XW2Z-200C Connecting Cable to wire inputs.

Common Specifications for Process and Analog I/O Units

| Item | Specifications | | | | |
|--|--|----------------------------------|-----------------------------|-----------------|---------------------|
| Unit classification | CS-series Special I/O Unit | | | | |
| Dimensions | 35 × 130 × 126 mm (W × H × D) | | | | |
| Weight | 450 g max. | | | | |
| External connection terminals | CS1W-PTS55/56, PDC55: 24-point detachable terminal block (lever type) (M3 screws, with tightening torque of 0.5 N·m) CS1W-AD161: MIL connectors (34-pin × 2) Other models: 21-point detachable terminal block (M3 screws, with tightening torque of 0.5 N·m) | | | | |
| Unit number switch | 00 to 95 | | | | |
| Self-diagnostic function | Results shown by LED indicators. | | | | |
| Mounting position | CS-series CPU Rack or CS-series Expansion Rack | | | | |
| Internal current consumption | Confirm that the total current consumption of all the Units (including the CPU Unit) mounted to a single CPU Rack or Expansion Rack does not exceed the maximum power supplied by the Power Supply Unit. | | | | |
| | Name | Model | Current consumption (power) | | |
| | | | 5 V | 26 V | |
| Isolated-type Thermocouple Input Unit | | CS1W-PTS01-V1 | 0.15 A (0.75 W) | 0.15 A (3.9 W) | |
| | | CS1W-PTS11 | 0.12 A (0.6 W) | 0.08 A (2.08 W) | |
| | | CS1W-PTS51 | 0.25 A (1.25 W) | Unused. | |
| | | CS1W-PTS55 | 0.18 A (0.9 W) | 0.06 A (1.56 W) | |
| Isolated-type Resistance Thermometer Input Unit (Pt100, JPt100) | | CS1W-PTS02 | 0.15 A (0.75 W) | 0.15 A (3.9 W) | |
| Isolated-type Resistance Thermometer Input Unit (Ni508.4 Ω) | | CS1W-PTS03 | 0.15 A (0.75 W) | 0.15 A (3.9 W) | |
| Isolated-type Resistance Thermometer Input Unit (Pt100, JPt100, Ni508.4 Ω) | | CS1W-PTS12 | 0.12 A (0.6 W) | 0.07 A (1.82 W) | |
| Isolated-type Resistance Thermometer Input Unit (Pt100, JPt100) | | CS1W-PTS52 | 0.25 A (1.25 W) | Unused. | |
| | | CS1W-PTS56 | 0.18 A (0.9 W) | 0.06 A (1.56 W) | |
| Isolated-type 2-Wire Transmitter Input Unit | | CS1W-PTW01 | 0.15 A (0.75 W) | 0.16 A (4.2 W) | |
| Isolated-type DC Input Unit | | CS1W-PDC01 | 0.15 A (0.75 W) | 0.16 A (4.2 W) | |
| | | CS1W-PDC11 | 0.12 A (0.6 W) | 0.12 A (3.12 W) | |
| | | CS1W-PDC55 | 0.18 A (0.9 W) | 0.06 A (1.56 W) | |
| Power Transducer Input Unit | | CS1W-PTR01 | 0.15 A (0.75 W) | 0.08 A (2.1 W) | |
| Analog Input Unit (100 mV) | | CS1W-PTR02 | 0.15 A (0.75 W) | 0.08 A (2.1 W) | |
| Isolated-type Pulse Input Unit | | CS1W-PPS01 | 0.20 A (1.0 W) | 0.16 A (4.2 W) | |
| Isolated-type Analog Output Units | | CS1W-PMV01 | 0.15 A (0.75 W) | 0.16 A (4.2 W) | |
| | | CS1W-PMV02 | 0.12 A (0.6 W) | 0.12 A (3.2 W) | |
| Analog Input Units | | CS1W-AD041-V1 | 0.12 A (0.6 W) | 0.09 A (2.34 W) | |
| | | CS1W-AD081-V1 | | | |
| | | CS1W-AD161 | 0.15 A (0.75 W) | 0.06 A (1.56 W) | |
| Analog Output Units | | CS1W-DA041 | 0.13 A (0.65 W) | 0.18 A (4.68 W) | |
| | | CS1W-DA08V | | | |
| | | CS1W-DA08C | | 0.25 A (6.5 W) | |
| Analog I/O Unit | | CS1W-MAD44 | 0.2 A (1.0 W) | 0.2 A (5.2 W) | |
| | (Reference) Maximum current and total power supplied | | | | |
| | Power Supply Unit | Maximum current supplied (power) | | | Maximum total power |
| | | 5 V | 26 V | 24 V | |
| | C200HW-PA204 | 4.6 A (23 W) | 0.6 A (15.6 W) | None | 30 W |
| | C200HW-PA204S | | | 0.8 A (19.2 W) | |
| | C200HW-PA204R | | | None | |
| | C200HW-PD024 | | | | |
| | C200HW-PD025 | 5.3 A (26.5 W) | 1.3 A (33.8 W) | | 40 W |
| | C200HW-PA209R | 9 A (45 W) | 1.3 A (33.8 W) | | 45 W |
| | CS1D-PA207R | 7 A (35 W) | 1.3 A (33.8 W) | | 35 W |
| | CS1D-PD024 | 4.3 A (21.5 W) | 0.56 A (14.6 W) | | 28 W |
| | CS1D-PD025 | 5.3 A (26.5 W) | 1.3 A (33.8 W) | | 40 W |
| Ambient operating temperature | 0 to 55°C | | | | |
| Ambient operating humidity | 10% to 90% (no condensation) | | | | |
| Isolation | Between I/O, and between inputs and the Backplane. There is no isolation, however, between inputs for Power Supply Transducer Input Units, Current Input Units (100 mV), Analog Input Units, Analog Output Units, and I/O Units. | | | | |
| Insulation resistance | 20 MΩ min. (at 500 V DC) between isolated sections | | | | |
| Dielectric strength | 1,000 V AC between isolated sections | | | | |

Note: Process Analog I/O Units can be used even if a Loop Control Board is not used.

Utility Software

Touch Panel Software

■ Face Plate Auto-Builder for NS

Simply specify the CSV tag file created using the CX-Process Tool to automatically create a project constructed with a Face Plate for Loop-control CPU Units for use with OMRON's NS-series Programmable Terminals.

Function Overview

- Create windows for monitoring and tuning PID and other function blocks for up to 100 loops (NS System version 4 or higher).
- NS project files for monitoring multiple Loop-control CPU Units from a single NS-series PT can be generated from CX-Process projects for up to 32 multiple nodes.
- When a Segment Program 2 or 3 function block is used for program operation, the Detailed Setting Windows (Time Interval vs. Output Value Setting Window, Wait Interval Setting Window) used for the parameter settings are also automatically generated.

Basic Specifications

| Item | | Specifications |
|-------------------------|--|--|
| Name | | Face Plate Auto-Builder for NS (Included in CX-One Package) |
| Model number | | CXONE-AL□□D-V□ |
| Applicable PLC products | | CJ-series Loop-control CPU Units CS-series Loop Control Boards (unit version 1.0 or later) CS1D Process-control CPU Units |
| Applicable PTs | | NS-series NS12, NS10, and NS8 (PT version 2.0 or later) CX-Designer |
| System requirements | Computer | IBM PC/AT or compatible |
| | Operating system (OS) (See note 1, 2.) Japanese or English system | Windows 7 (32-bit/64-bit version) / Windows 8 (32-bit/64-bit version) / Windows 8.1 (32-bit/64-bit version) / Windows 10 (32-bit/64-bit version) |
| | CPU | Processor recommended by Microsoft. |
| | Memory (See note 3.) | Memory recommended by Microsoft. |
| | Hard disk | Approx. 2.8 GB or more available space is required to install the complete CX-One. |
| | Display | XGA (1,024 x 768), High-Color (16-bit) or higher. |
| | Disk drive | CD-ROM drive or DVD-ROM drive |
| Communications ports | | RS-232C port, USB port, or Ethernet port (see note 2.) |
| Basic functions | | Number of generated loops: 100 max., control windows and tuning windows Applicable face plates: 2-position ON/OFF, 3-position ON/OFF, Basic PID, Advanced PID, Indication and Operation, Indicator, Segment Program 2 (includes the parameter setting windows), Segment Program 3 (includes the parameter setting windows) Number of loops in control windows: 6 loops per window for NS12, 4 loops per window for NS10/NS8 Realtime trend in tuning window: 1-second cycle |

Note: 1. CX-One Operating System Precaution :

- 1) System requirements and hard disk space may vary with the system environment.
2. Refer to the hardware manual for your PLC for hardware connection methods and cables to connect the computer and PLC.

Example of Automatically Created Windows

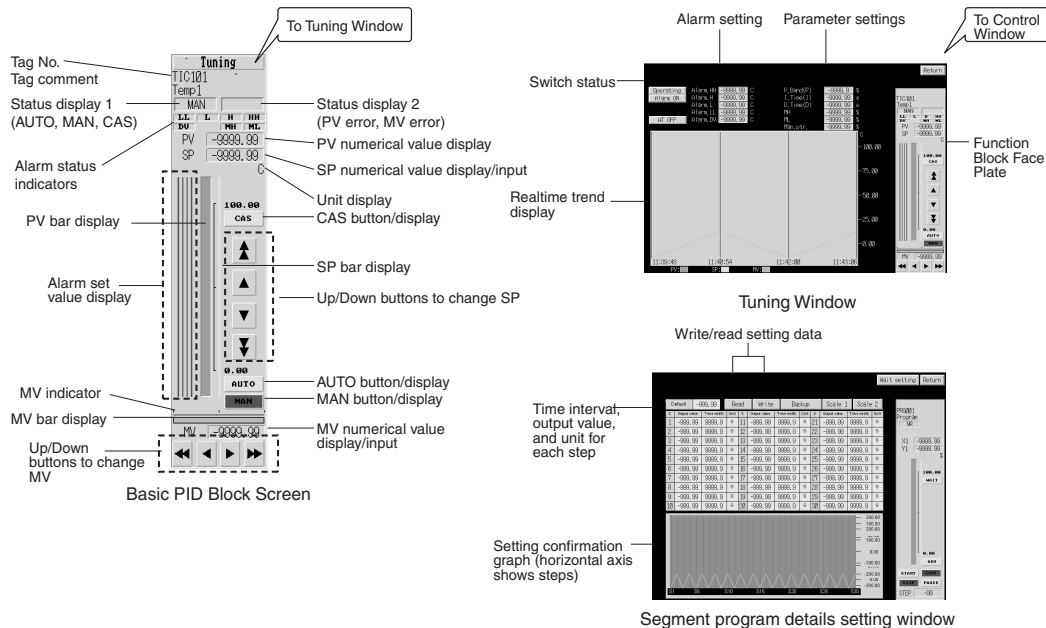

RSView 32-related Software

■ SYSMAC OPC Server (Product no longer available to order.)

The SYSMAC OPC Server is an application that runs on Windows 2000, NT, or XP as a local/remote server for OPC Data Access 2.0. It is required to connect to RSView32.

Basic Specifications

| Item | Specifications | |
|-------------------------|---------------------------------------|--|
| Name | SYSMAC OPC Server V2 | |
| Model number | WS02-OPCC1-E | |
| Applicable PLC products | CS, CJ, CV, CMV1, C200HX/HG/HE, CQM1H | |
| System requirements | Computer | IBM PC/AT or compatible |
| | CPU | Intel Pentium, Celeron 400 MHz or better recommended |
| | OS | Microsoft Windows NT4.0, 2000, or XP |
| | Memory | Recommended: 128 Mbytes min. |
| | Hard disk storage | Recommended: 100 Mbytes free space min. |

Note: FinsGateway version 3 is included with this product, so there is no need to purchase it separately.

■ Faceplate Components for Loop Controllers (Product no longer available to order.)

Function block control and monitoring is enabled by simply pasting faceplate objects corresponding to Loop Controller function blocks into RSView32. (SYSMAC OPC Server is required to use this function.)

Basic Specifications

| Item | Specifications |
|-------------------------|---|
| Name | Loop Controller Faceplate Objects (CX-Process 2 Control) |
| Model number | WS02-LCFC1-EV2 |
| Applicable PLC products | CS-series Loop Control Boards CS1D Process-control CPU Units CJ-series Loop-control CPU Units |

Utility Software

RSView 32-related Software

| Item | | Specifications |
|---------------------|---|--|
| System requirements | Computer | IBM PC/AT or compatible |
| | CPU | SYSMAC OPC Server version 2.6 or later and RSView32 version 7.0 or later |
| | OS | |
| | Memory | |
| | Hard disk storage | |
| Basic functions | <p>Applicable face plates: 2-position ON/OFF (See note.), 3-position ON/OFF (See note.), Basic PID (See note.), Advanced PID (See note.), Blended PID (See note.), Batch Flowrate Capture (See note.), Indication and Setting (See note.), Indication and Operation (See note.), Ratio Setting (See note.), Indicator (See note.), ES100X Controller Terminal (See note.), High/Low Alarm, Segment Program 2, Timer, Counter, ON/OFF Valve Manipulator, Motor Manipulator, Reversible Motor Manipulator, Motor Opening Manipulator, User Link Table tags</p> <p>Number of loops in control windows: 8 loops per window Realtime trend in tuning window: 1-second cycle The control log from the faceplate can be recorded in the RSView32 activity log.</p> | |

Note: Includes the Tuning Parameter Screen. Enabled when using the sample project included with the product.

Dimensions

Dimensions

CPU Units

■ CS1D Process-control CPU Units (Unit: mm)

CS1D-CPU65P
CS1D-CPU67P

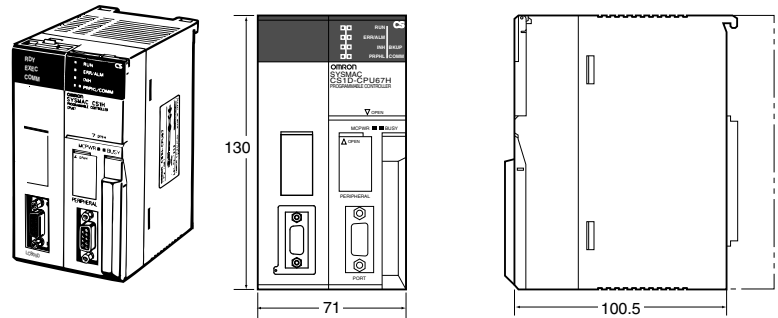

Inner Boards

■ Loop Control Boards (Unit: mm)

CS1W-LCB01
CS1W-LCB05(-GTC)

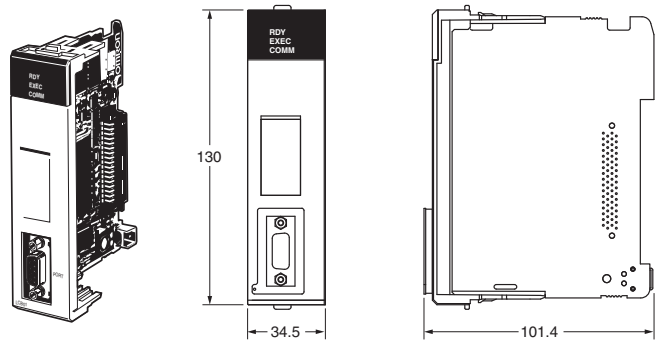

Dimensions

Special I/O Units

■ Analog I/O Units (Unit: mm)

Process Analog I/O Units

- CS1W-PTS11
- CS1W-PTS12
- CS1W-PDC11
- CS1W-PTS51
- CS1W-PTS52
- CS1W-PTS55
- CS1W-PTS56
- CS1W-PTS01-V1
- CS1W-PTS02
- CS1W-PTS03
- CS1W-PTW01
- CS1W-PDC01
- CS1W-PDC55
- CS1W-PPS01
- CS1W-PMV01
- CS1W-PMV02
- CS1W-PTR01
- CS1W-PTR02

Standard Analog I/O Units

- CS1W-AD041-V1
- CS1W-AD081-V1
- CS1W-DA041
- CS1W-DA08V
- CS1W-DA08C

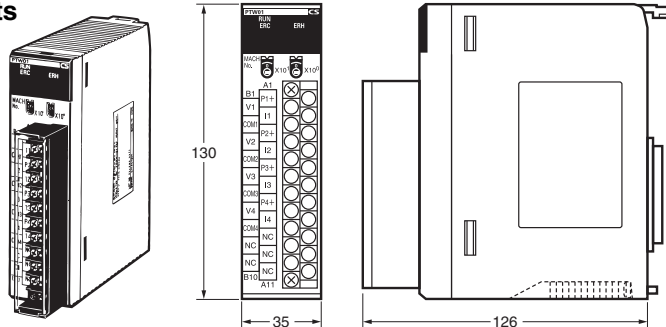

Analog Input Units

- CS1W-AD161

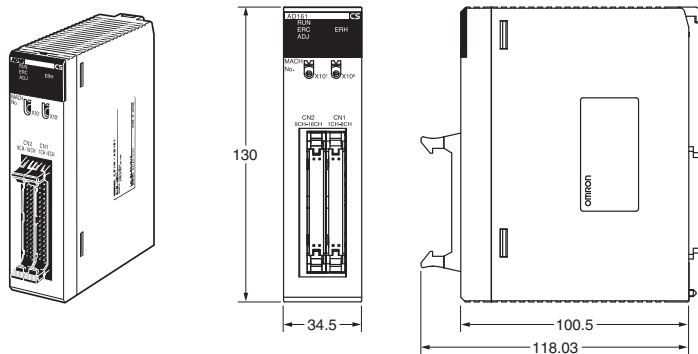

Ordering Information

| | |
|---|----|
| Selection Guide | 33 |
| Basic PLC Components | 34 |
| CS1D Duplex Systems | 35 |
| Loop Control Boards | 36 |
| Process Analog I/O Units | 36 |
| Standard Analog I/O Units | 37 |
| Connector-Terminal Block Conversion Unit and Connecting Cable for CS1W-AD161 | 37 |
| SYSMAC SPU Units (Storage and Processing Units) | 37 |
| Basic I/O Units | 38 |
| CPU Bus Units (Network Units) | 39 |
| Support Software | 40 |
| NS-series Programmable Terminals | 45 |
| NS-Runtime | 45 |

Applicable Standards

Refer to the OMRON website (www.ia.omron.com) or ask your OMRON representative for the most recent applicable standards for each model.

■ EU Directives

The EU Directives applicable to PLCs include the EMC Directives and the Low Voltage Directive. OMRON complies with these directives as described below.

EMC Directives

Applicable Standards

EMI:EN61000-6-4

EMS:EN61131-2 and EN61000-6-2 (See note.)

PLCs are electrical devices that are incorporated in machines and manufacturing installations. OMRON PLCs conform to the related EMC standards so that the devices and machines into which they are built can more easily conform to EMC standards. The actual PLCs have been checked for conformity to EMC standards. Whether these standards are satisfied for the actual system, however, must be checked by the customer.

EMC-related performance will vary depending on the configuration, wiring, and other conditions of the equipment or control panel in which the PLC is installed. The customer must, therefore, perform final checks to confirm that the overall machine or device conforms to EMC standards.

Note: The applicable EMI standard depends on the product.

Low Voltage Directive

Applicable Standard

EN61131-2

Devices that operate at voltages from 50 to 1,000 VAC or 75 to 150 VDC must satisfy the appropriate safety requirements. With PLCs, this applies to Power Supply Units and I/O Units that operate in these voltage ranges.

These Units have been designed to conform to EN61131-2, which is the applicable standard for PLCs.





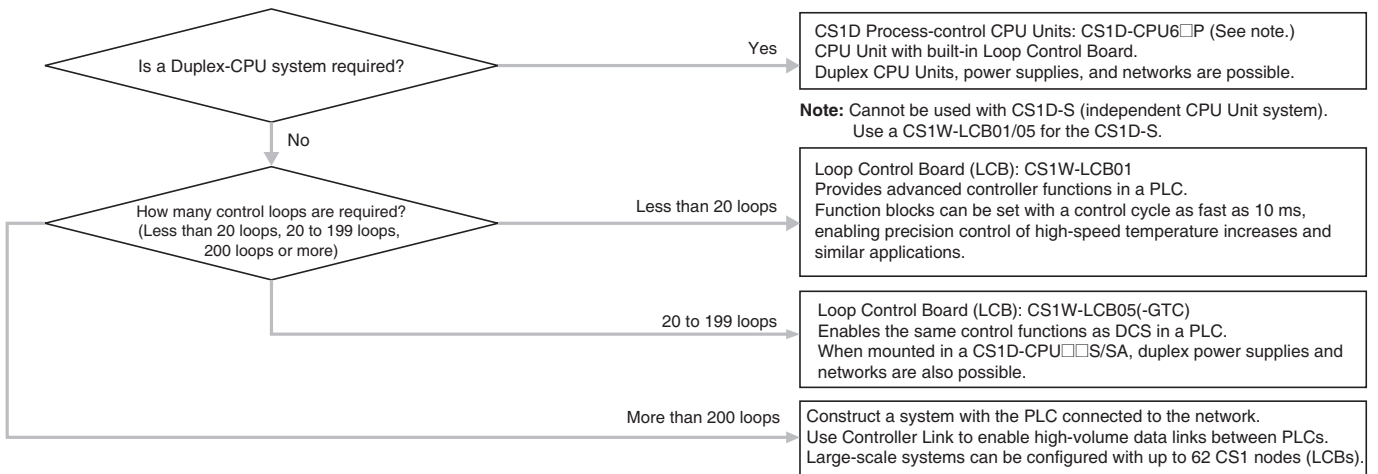

Ordering Information

Selection Guide

■ Process Control



Basic PLC Components

| Name | Specifications | | | Model |
|--|---|--|---|-------------------------------|
|  <p>CPU Units</p> | I/O bits | Program capacity | Data memory capacity | --- |
| | 5,120 | 250K steps | 448K words (DM: 32K words, EM: 32K words ×13 banks) | CS1H-CPU67H |
| | 5,120 | 120K steps | 256K words (DM: 32K words, EM: 32K words ×7 banks) | CS1H-CPU66H |
| | 5,120 | 60K steps | 128K words (DM: 32K words, EM: 32K words ×3 banks) | CS1H-CPU65H |
| | 5,120 | 30K steps | 64K words (DM: 32K words, EM: 32K words ×1 bank) | CS1H-CPU64H |
| | 5,120 | 20K steps | 64K words (DM: 32K words, EM: 32K words ×1 bank) | CS1H-CPU63H |
| | 5,120 | 60K steps | 128K words (DM: 32K words, EM: 32K words ×3 banks) | CS1G-CPU45H |
| | 1,280 | 30K steps | 64K words (DM: 32K words, EM: 32K words ×1 bank) | CS1G-CPU44H |
| | 960 | 20K steps | 64K words (DM: 32K words, EM: 32K words ×1 bank) | CS1G-CPU43H |
| 960 | 10K steps | 64K words (DM: 32K words, EM: 32K words ×1 bank) | CS1G-CPU42H | |
|  <p>CPU Backplanes</p> | 2 slots (Does not connect to Expansion Rack.) | | | CS1W-BC023 |
| | 3 slots | | | CS1W-BC033 |
| | 5 slots | | | CS1W-BC053 |
| | 8 slots | | | CS1W-BC083 |
| | 10 slots | | | CS1W-BC103 |
|  <p>Power Supply Units</p> | 100 to 240 V AC (wide range) Output capacity: 4.6 A, 5 VDC, with maintenance forecast function | | | C200HW-PA204C |
| | 100 to 120 V AC or 200 to 240 V AC, Output capacity: 4.6 A, 5 V DC, 0.625 A, 26 V DC, Total: 30 W max. | | | C200HW-PA204 |
| | 100 to 120 V AC or 200 to 240 V AC (with 0.8 A 24 V DC service power supply) Output capacity: 4.6 A, 5 V DC, 0.625 A, 26 V DC, Total: 30 W max. | | | C200HW-PA204S |
| | 100 to 120 V AC or 200 to 240 V AC (with RUN output) Output capacity: 4.6 A, 5 V DC, 0.625 A, 26 V DC, Total: 30 W max. | | | C200HW-PA204R |
| | 100 to 120 V AC or 200 to 240 V AC (with RUN output) Output capacity: 9 A, 5 VDC, 1.3 A, 26 V DC, Total: 45 W max. | | | C200HW-PA209R |
| | 24 V DC, Output capacity: 4.6 A, 5 V DC, 0.625 A, 26 V DC, Total: 30 W max. | | | C200HW-PD024 |
| 24 V DC, Output capacity: 5.3 A, 5 V DC, 1.3 A, 26 V DC, Total: 40 W max. | | | C200HW-PD025 | |
|  <p>Memory Cards</p> | Flash memory, 128 MB | | | HMC-EF183 |
| | Memory Card Adapter (for computer PCMCIA slot) | | | HMC-AP001 |
| <p>Serial Communications Boards</p> | 2 × RS-232C ports, protocol macro function | | | CS1W-SCB21-V1 |
| | 1 × RS-232C port + 1 × RS-422/485 port, protocol macro function | | | CS1W-SCB41-V1 |
|  <p>Programming Consoles</p> | An English Keyboard Sheet (CS1W-KS001-E) is required. Note: Connects to peripheral port on CPU Unit only. (Cannot connect to RS-232C port.) | | | CQM1-PRO01-E C200H-PRO27-E |
| | For C200H-PRO27 and CQM1-PRO01 | | | CS1W-KS001-E |
|  <p>Programming Console Connecting Cables</p> | Connects the C200H-PRO27-E Programming Console. (Length: 2.0 m) | | | CS1W-CN224 |
| | Connects the C200H-PRO27-E Programming Console. (Length: 6.0 m) | | | CS1W-CN624 |
| <p>Connector Cover</p> | Protects unused Backplane connectors (Power Supply Unit connectors) | | | C500-COV01 |
| | Protects unused Backplane connectors (I/O Unit connectors) | | | CV500-COV01 |
| <p>Space Unit</p> | For unused I/O slot spaces | | | CS1W-SP001 |
| | For unused power supply slot spaces (same shape as PA207R) | | | CS1D-SP001 |
| | For unused power supply slot spaces (same shape as PA204) | | | CS1D-SP002 |

CS1D Duplex Systems

■ For Duplex-CPU Systems

| Name | Specifications | | | | Model |
|---|--|------------------|----------------------|---------------------|--------------|
| | I/O bits | Program capacity | Data memory capacity | Programming | |
| CS1D CPU Units (For Duplex-CPU Systems) | 5,120 | 60K steps | 128K words | Ladder | CS1D-CPU65H |
| | | 250K steps | 448K words | Ladder | CS1D-CPU67H |
| | | 250K steps | 448K words | Ladder, FB, ST, SFC | CS1D-CPU67HA |
| | | 400K steps | 832K words | Ladder, FB, ST, SFC | CS1D-CPU68HA |
| CS1D Process-control CPU Units (For Duplex-CPU Systems) | CPU Unit: CS1D-CPU65H Loop Control Board: CS1D-LCB05D, 500 function blocks max. | | | | CS1D-CPU65P |
| | CPU Unit: CS1D-CPU67H Loop Control Board: CS1D-LCB05D, 500 function blocks max. | | | | CS1D-CPU67P |
| Duplex Unit (For Duplex-CPU Systems) | Unit for Duplex CPU Systems | | | | CS1D-DPL01 |
| | Unit for Duplex CPU Systems (Can be replaced online.) | | | | CS1D-DPL02D |
| CPU Backplane (For Duplex-CPU Systems) | 5 slots | | | | CS1D-BC052 |
| CS1D Power Supply Unit (Used for both Duplex-CPU Systems and Single-CPU Systems) | 100 to 120 V AC or 200 to 240 V AC (supports output during operation) Output capacity: 7 A, 5 V DC, 1.3 A, 26 V DC, Total: 35 W max. (Used for both Duplex-CPU Systems and Single-CPU Systems) | | | | CS1D-PA207R |
| | 24 V DC, Output capacity: 4.3 A, 5 V DC, 0.56 A, 26 V DC, Total: 28 W max. (Used for both Duplex-CPU Systems and Single-CPU Systems) | | | | CS1D-PD024 |
| | 24 V DC, Output capacity: 5.3 A, 5 V DC, 1.3 A, 26 V DC, Total: 40 W max. (Used for both Duplex-CPU Systems and Single-CPU Systems) | | | | CS1D-PD025 |

■ For Single-CPU Systems (See note.)

| Name | Specifications | | | | Model |
|---|--|------------------|----------------------|---------------------|---------------------|
| | I/O bits | Program capacity | Data memory capacity | Programming | |
| CS1D CPU Units (for Single-CPU Systems) | 5,120 | 60K steps | 128K words | Ladder | CS1D-CPU65S |
| | | 250K steps | 448K words | Ladder | CS1D-CPU67S |
| | 1,280 | 30K steps | 64K words | Ladder | CS1D-CPU44S |
| | | 960 | 10K steps | 64K words | Ladder |
| | 5,120 | 250K steps | 448K words | Ladder, FB, ST, SFC | CS1D-CPU67SA |
| | | 1,280 | 30K steps | 64K words | Ladder, FB, ST, SFC |
| CPU Backplane (for Single-CPU Systems) | 8 slots | | | | CS1D-BC082S |
| CS1D Power Supply Unit (Used for both Duplex-CPU Systems and Single-CPU Systems) | 100 to 120 V AC or 200 to 240 V AC (supports output during operation) Output capacity: 7 A, 5 V DC, 1.3 A, 26 V DC, Total: 35 W max. (Used for both Duplex-CPU Systems and Single-CPU Systems) | | | | CS1D-PA207R |
| | 24 V DC, Output capacity: 4.3 A, 5 V DC, 0.56 A, 26 V DC, Total: 28 W max. (Used for both Duplex-CPU Systems and Single-CPU Systems) | | | | CS1D-PD024 |
| | 24 V DC, Output capacity: 5.3 A, 5 V DC, 1.3 A, 26 V DC, Total: 40 W max. (Used for both Duplex-CPU Systems and Single-CPU Systems) | | | | CS1D-PD025 |

Note: Loop Control Board Unit Ver. 1.5 or later is required when using the Loop Control Board. Do not use a unit version earlier than Unit Ver. 1.5.

■ Expansion Units

| Name | Specifications | Model |
|---|---|------------|
| I/O Control Unit | For distances exceeding 12 m (50 m max.), equipped with two terminating resistors | CS1W-IC102 |
| I/O Interface Unit | For distances exceeding 12 m (50 m max.) | CS1W-II102 |
| Expansion Backplane (supports online replacement) (Used for both Duplex-CPU Systems and Single-CPU Systems) | 9 slots | CS1D-BI092 |

Loop Control Boards

| Unit name | Specifications | Model |
|---------------------|---|----------------|
| Loop Control Boards | No. of function blocks: 50 blocks max. | CS1W-LCB01 |
| | No. of function blocks: 500 blocks max. | CS1W-LCB05 |
| | | CS1W-LCB05-GTC |

Note: Use a CS1D-CPU6□P CS1D Process-control CPU Unit (for Duplex-CPU System) when duplex operation is required.
Use the CS1W-LCB0□ Loop Control Board when using a CS1D CPU Unit for a Single-CPU System

Process Analog I/O Units

| Name | Specifications | Model |
|--|---|---------------|
| Isolated-type Thermocouple Input Unit (high-resolution type) | 4 inputs, B, E, J, K, L, N, R, S, T, U, WRe5-26, PL II, ± 100 mV | CS1W-PTS11 |
| Isolated-type Resistance Thermometer Input Unit (high-resolution type) | 4 inputs, Pt100 Ω (JIS, IEC), JPt100 Ω , Pt50 Ω , Ni508.4 Ω | CS1W-PTS12 |
| Isolated-type DC Input Unit (high-resolution type) | 4 inputs, 4 to 20 mA, 0 to 20 mA, 0 to 10 V, ± 10 V, 0 to 5 V, ± 5 V, 1 to 5 V, 0 to 1.25 V, ± 1.25 V | CS1W-PDC11 |
| Isolated-type Thermocouple Input Unit (economical type) | 4 inputs, R, S, K, J, T, L, B | CS1W-PTS51 |
| | 8 inputs, R, S, K, J, T, L, B | CS1W-PTS55 |
| Isolated-type Resistance Thermometer Input Unit (economical type) | 4 inputs, JPt100, Pt100 (JIS, IEC) | CS1W-PTS52 |
| | 8 inputs, JPt100, Pt100 (JIS, IEC) | CS1W-PTS56 |
| Isolated-type Analog Input Unit (economical type) | 8 inputs, 4 to 20 mA, 0 to 10 V, 0 to 5 V, 1 to 5 V | CS1W-PDC55 |
| Isolated-type Thermocouple Input Unit | 4 inputs, B, E, J, K, N, R, S, T; ± 80 mV | CS1W-PTS01-V1 |
| Isolated-type Resistance Thermometer Input Unit | 4 inputs, Pt100, JPt100 | CS1W-PTS02 |
| Isolated-type Resistance Thermometer Input Unit (Ni508.4 Ω) | 4 inputs, Ni508.4 Ω | CS1W-PTS03 |
| Isolated-type 2-Wire Transmitter Input Unit | 4 inputs, 4 to 20 mA, 1 to 5 V | CS1W-PTW01 |
| Isolated-type Analog Input Unit | 4 inputs, 4 to 20 mA, 0 to 20 mA, 1 to 5 V, 0 to 5 V, ± 5 V, 0 to 10 V, ± 10 V | CS1W-PDC01 |
| Isolated-type Pulse Input Unit | 4 inputs | CS1W-PPS01 |
| Isolated-type Analog Output Unit | 4 outputs, 4 to 20 mA, 1 to 5 V | CS1W-PMV01 |
| | 4 outputs, 0 to 10 V, ± 10 V, 0 to 5 V, ± 5 V, 0 to 1 V, ± 1 V | CS1W-PMV02 |
| Power Transducer Input Unit | 8 inputs, 0 to 1 mA, ± 1 mA | CS1W-PTR01 |
| Analog Input Unit (100 mV) | 8 inputs, 0 to 100 mV, ± 100 mV | CS1W-PTR02 |

Ordering Information

Standard Analog I/O Units

Standard Analog I/O Units

| Name | Specifications | Model |
|---------------------|---|---------------|
| Analog Input Units | 4 inputs (1 to 5 V, 0 to 5 V, 0 to 10 V, -10 to 10 V, 4 to 20 mA), Resolution: 1/8,000 (See note.) | CS1W-AD041-V1 |
| | 8 inputs (1 to 5 V, 0 to 5 V, 0 to 10 V, -10 to 10 V, 4 to 20 mA), Resolution: 1/8,000 (See note.) | CS1W-AD081-V1 |
| | 16 inputs (1 to 5 V, 0 to 5 V, 0 to 10 V, -10 to 10 V, 4 to 20 mA), Resolution: 1/8,000 (See note.) | CS1W-AD161 |
| Analog Output Units | 4 outputs (1 to 5 V, 0 to 5 V, 0 to 10 V, -10 to 10 V, 4 to 20 mA), Resolution: 1/4,000 | CS1W-DA041 |
| | 8 outputs (1 to 5 V, 0 to 5 V, 0 to 10 V, -10 to 10 V), Resolution: 1/4,000 | CS1W-DA08V |
| | 8 outputs (4 to 20 mA), Resolution: 1/4,000 | CS1W-DA08C |
| Analog I/O Unit | 4 inputs (1 to 5 V, 0 to 5 V, 0 to 10 V, -10 to 10 V, 4 to 20 mA), Resolution: 1/4,000 | CS1W-MAD44 |
| | 4 outputs (1 to 5 V, 0 to 5 V, 0 to 10 V, -10 to 10 V), Resolution: 1/4,000 | |

Note: Resolution: 1/4,000 is also possible.

Connector-Terminal Block Conversion Unit and Connecting Cable for CS1W-AD161

| Name | Specifications | Model |
|---|---|-----------|
| Connector-Terminal Block Conversion Unit | 34 terminal, dimensions: 128 × 40 × 39 mm | XW2D-34G6 |
| Connector-Terminal Block Conversion Unit Connecting Cable | Length: 2 m | XW2Z-200C |

SYSMAC SPU Units (Storage and Processing Units)

| Name | Specifications | Model |
|-----------------------------------|--------------------------------------|---------------|
| SYSMAC SPU Unit | One Ethernet port, one PC card slot | CS1W-SPU01-V2 |
| | Two Ethernet ports, one PC card slot | CS1W-SPU02-V2 |
| SPU Basic Software (See note 1.) | SPU Unit Setting Software | WS02-SPTC1-V2 |
| Memory Cards | 128-MB compact flash card | HMC-EF183 |
| | 256-MB compact flash card | HMC-EF283 |
| | 512-MB compact flash card | HMC-EF583 |
| Memory Card Adapter (See note 2.) | For PC card slot | HMC-AP001 |
| Ethernet Cross Cables | 2-m cable (made by corega KK) | CG-UTP02WXA |
| | 3-m cable (made by corega KK) | CG-UTP03WXA |

- Note:**
1. Required for data collection settings.
 2. Required to install the Memory Card in the SPU Unit.

Basic I/O Units

| Classification | Name | Specifications | Model |
|---|--------------------------|---|--|
| Input Units | DC Input Units | 24 V DC, 16 inputs, 7 mA | CS1W-ID211 |
| | | 24 V DC, 32 inputs, 6 mA | CS1W-ID231 |
| | | 24 V DC, 64 inputs, 6 mA | CS1W-ID261 |
| | | 24 V DC, 96 inputs, approx. 5 mA | CS1W-ID291 |
| | AC Input Units | 100 to 120 V AC, 100 to 120 V DC, 16 inputs | CS1W-IA111 |
| | | 200 to 240 V AC, 16 inputs | CS1W-IA211 |
| | Interrupt Input Unit | 24 V DC, 16 inputs, 7 mA | CS1W-INT01 |
| High-speed Input Unit | 24 V DC, 16 inputs, 7 mA | CS1W-IDP01 | |
| Output Units | Relay Output Units | 250 V AC, 2 A max.; 24 VDC, 2 A max.; 120 V DC, 0.1 A max.; independent contacts, 8 outputs | CS1W-OC201 |
| | | 250 V AC or 24 V DC, 2 A max.; 120 V DC 0.1 A max.; 16 outputs | CS1W-OC211 |
| | Transistor Output Units | 12 to 24 V DC, 0.5 A, 16sinking outputs | CS1W-OD211 |
| | | 24 V DC, 0.5A, 16sourcing outputs (load short-circuit protection, with alarm) | CS1W-OD212 |
| | | 12 to 24 V DC, 0.5 A, 32sinking outputs | CS1W-OD231 |
| | | 24 V DC, 0.5 A, 32 sourcing outputs (load short-circuit protection, with alarm) | CS1W-OD232 |
| | | 12 to 24 V DC, 0.3 A, 64 sinking outputs | CS1W-OD261 |
| | | 24 V DC, 0.3 A, 64 sourcing outputs (load short-circuit protection, with alarm) | CS1W-OD262 |
| | | 12 to 24 V DC, 0.1 A, 96 sinking outputs | CS1W-OD291 |
| | Triac Output Units | 12 to 24 V DC, 0.1 A, 96 sourcing outputs | CS1W-OD292 |
| | | 250 V AC, 1.2 A max., 8 outputs | CS1W-OA201 |
| | | 250 V AC, 0.5 A max., 16 outputs | CS1W-OA211 |
| | I/O Units | DC Input/ Transistor Output Units | 24 V DC, 6 mA, 32 inputs, 12 to 24 V DC, 0.3 A, 32 sinking outputs |
| 24 V DC, 6 mA, 32 inputs, 24 V DC, 0.3 A, 32 sourcing outputs (load short-circuit protection, with alarm) | | | CS1W-MD262 |
| 24 V DC, approx. 5 A, 48 inputs, 12 to 24 V DC, 0.1 A, 48 outputs, sinking inputs/outputs | | | CS1W-MD291 |
| 24 V DC, approx. 5 A, 48 inputs, 12 to 24 V DC, 0.1 A, 48 outputs, sourcing inputs/outputs | | | CS1W-MD292 |
| TTL I/O Unit | | 5 V DC, 32 inputs, 32 outputs | CS1W-MD561 |

Note: C200H/C200HW Basic I/O Units can also be mounted.

Ordering Information

CPU Bus Units (Network Units)

CPU Bus Units (Network Units)

| Name | Specifications | Model |
|----------------------------|--|---------------|
| Controller Link Units | Wired Unit, shielded twisted-pair cable (See note 1.) | CS1W-CLK23 |
| | Optical ring for H-PCF cable (See note 2.), supports duplex communications | CS1W-CLK13 |
| | Optical ring for GI cable (See note 3.), supports duplex communications | CS1W-CLK53 |
| SYSMAC LINK Units | Coaxial cable (5C-2V cable) | CS1W-SLK21 |
| | Optical cable (H-PCF cable) | CS1W-SLK11 |
| Serial Communications Unit | Two RS-232C Ports | CS1W-SCU21-V1 |
| | Two RS-422A/485 ports | CS1W-SCU31-V1 |
| Ethernet Unit | 100Base-TX (10Base-T) FINS communications (TCP/IP and UDP/IP format), socket service, FTP server, mail transmission | CS1W-ETN21 |
| | 100Base-TX (10Base-T), supports duplex communications (FINS communications (TCP/IP, UDP/IP), socket service, FTP server, mail send/receive) | CS1D-ETN21D |
| FL-net Unit | FL-net (OPCN-2), 100Base-TX | CS1W-FLN22 |
| DeviceNet Unit | Functions as remote I/O master and/or slave. | CS1W-DRM21-V1 |
| CompoNet Master Unit | Word Slaves: 2,048 max. (1,024 inputs and 1,024 outputs) Bit Slaves: 512 max. (256 inputs and 256 outputs) | CS1W-CRM21 |

Note: 1. Use the following special cable for shielded, twisted-pair cable.

- ESVC0.5 x 2C-13262 (Bando Electric Wire: Japanese Company)
- ESNC0.5 x 2C-99-087B (JMACS Japan Co., Ltd.: Japanese Company)
- ESPC 1P x 0.5 mm² (Nagaoka Electronic Wire Co., Ltd.: Japanese Company)
- Li2Y-FCY2 x 0.56qmm (Kromberg & Schubert, Komtec Department: German Company)
- 1 x 2 x AWG-20PE + Tr.CUSN + PVC (Draka Cables Industrial: Spanish Company)
- #9207 (Belden: US Company)

2. When using wire-to-optical (H-PCF) cable, use a H-PCF cable (for both Controller Link and SYSMAC LINK) or a H-PCF optical fiber cable with connector.
3. When using wire-to-optical (GI) cable, use a GI optical cable (for Controller Link)

Support Software

■ Support Software

| Product name | Specifications | Media | | Model |
|--|--|-----------------|-----|----------------|
| | | No. of licenses | | |
| FA Integrated Tool Package CX-One Ver. 4.□ | The CX-One is a comprehensive software package that integrates Support Software for OMRON PLC's and components. CX-One runs on the following OS. OS: Windows 7 (32-bit/64-bit version) / Windows 8 (32-bit/64-bit version) / Windows 8.1 (32-bit/64-bit version) / Windows 10 (32-bit/64-bit version) CX-One version 4.□ includes CX-Process Tool Ver.5.□ and FacePlate Auto-Builder for NS Ver.3.□. For details, refer to the CX-One Introduction Guide (Cat. No. R134). | --- | DVD | CXONE-AL00D-V4 |
| | | (Media only)* | | |
| | | 1 license | | CXONE-AL01D-V4 |
| | | 3 licenses | | CXONE-AL03D-V4 |
| | | 10 licenses | | CXONE-AL10D-V4 |
| | | 30 licenses | | CXONE-AL30D-V4 |
| 50 licenses | CXONE-AL50D-V4 | | | |

Note: Site licenses are available for users who will run CX-One on multiple computers. Ask your OMRON sales representative for details.

* The CXONE-AL00D-V4 contains only the DVD installation media for users who have purchased the CX-One Version 4.□ and does not include the license number. Enter the license number of the CX-One Version 4.□ when installing.
(The license number of the CX-One Version 3.□ or lower cannot be used for installation.)



Support Software in CX-One Ver.4.□

The following tables lists the Support Software that can be installed from CX-One.

| Support Software in CX-One | Outline |
|--------------------------------------|--|
| CX-Programmer | Application software to create and debug programs for SYSMAC CS/CJ/CP/NSJ-series, C-series, and CVM1/C-series CPU Units. Data can be created and monitored for high-speed-type Position Control Units and Position Control Units with EtherCAT interface. |
| CX-Integrator | Application software to build and set up FA networks, such as Controller Link, DeviceNet, CompoNet, CompoWay, and Ethernet networks. The Routing Table Component and Data Link Component can be started from here. DeviceNet Configuration functionality is also included. |
| Switch Box Utility | Utility software that helps you to debug PLCs. It helps you to monitor the I/O status and to monitor/change present values within the PLC you specify. |
| CX-Protocol | Application software to create protocols (communications sequences) between SYSMAC CS/CJ/CP/NSJ-series or C200HX/HG/HE Serial Communications Boards/Units and general-purpose external devices. |
| CX-Simulator | Application software to simulate SYSMAC CS/CJ/CP/NSJ-series CPU Unit operation on the computer to debug PLC programs without a CPU Unit. |
| CX-Position | Application software to create and monitor data for SYSMAC CS/CJ-series Position Control Units. (except for High-speed type) |
| CX-Motion-NCF | Application software to create and monitor data for SYSMAC CS/CJ-series Position Control Units with MECHATROLINK-II interface (NC□71). |
| CX-Motion-MCH | Application software to create data and monitor program and monitor data SYSMAC CS/CJ-series Motion Control Units with MECHATROLINK-II interface (MCH71). |
| CX-Motion | Application software to create data for SYSMAC CS/CJ-series, C200HX/HG/HE, and CVM1/CV-series Motion Control Units, and to create and monitor motion control programs. |
| CX-Drive | Application software to set and control data for Inverters and Servos. |
| CX-Process Tool | Application software to create and debug function block programs for SYSMAC CS/CJ-series Loop Controllers (Boards, Process Control CPU Units, and Loop Control CPU Units). |
| Faceplate Auto-Builder for NS | Application software that automatically outputs screen data as project files for NS-series PTs from tag information in function block programs created with the CX-Process Tool. |
| CX-Designer | Application software to create screen data for NS-series PTs. |
| NV-Designer | Application software to create screen data for NV-series small PTs. |
| CX-Configurator FDT | Application software for setting various units by installing its DTM module. |
| CX-Thermo | Application software to set and control parameters in components such as Temperature Control Units. |
| CX-FLnet | Application software for system setting and monitoring of SYSMAC CS/CJ-series FL-net Units |
| Network Configurator | Application software for set up and monitor tag datalink for CJ2 (Built-in EtherNet/IP) CPU Units and EtherNet/IP Units. |
| CX-Server | Middleware necessary for CX-One applications to communicate with OMRON components, such as PLCs, Display Devices, and Temperature Control Units. |
| PLC Tools (Installed automatically.) | A group of components used with CX-One applications, such as the CX-Programmer and CX-Integrator. Includes the following: I/O tables, PLC memory, PLC Setup, Data Tracing/Time Chart Monitoring, PLC Error Logs, File Memory, PLC clock, Routing Tables, and Data Link Tables. |

Ordering Information

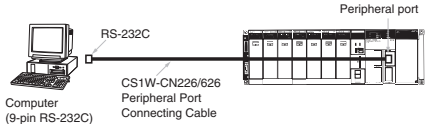
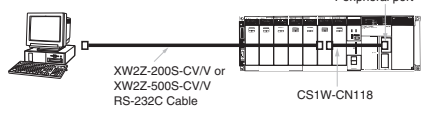
■ Connecting Cables for CX-One Components (e.g. CX-Programmer)

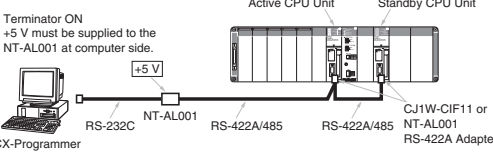
| Name | Specifications | | | | Model |
|---|--|--|--------------|--|--------------|
| | Applicable computers | Connection configuration | Cable length | Remarks | |
| Connecting Cables between Programming Device (computer) and peripheral port  | IBM PC/AT or compatible computer (D-Sub 9-pin) | IBM PC/AT or compatible computer ↔ CS1W-CN226/626 ↔ Peripheral port of CPU Unit (See note.)  <p>Note: If the system is a Duplex CPU System, connect to the active CPU Unit.</p> | 2 m | Can be used for both peripheral bus and host link. | CS1W-CN226 |
| | | CS1W-CN226/626 Peripheral Port Connecting Cable | 6 m | | CS1W-CN626 |
| | | The following configuration can be used when using an RS-232C cable to connect to an IBM PC/AT or compatible computer. IBM PC/AT or compatible computer ↔ XW2Z-200S-CV/V or XW2Z-500S-CV/V ↔ Peripheral port of CPU Unit (See note.)  <p>Note: If the system is a Duplex CPU System, connect to the active CPU Unit.</p> | 0.1 m | Use when connecting to the peripheral port with a CXW2Z-200S-CV/V or XW2Z-500S-CV/V RS-232C Cable. | CS1W-CN118 |
| Connecting Cables between Programming Device (computer) and RS-232C port  | IBM PC/AT or compatible computer (D-Sub 9-pin) | IBM PC/AT or compatible computer ↔ XW2Z-200S-CV/V or XW2Z-500S-CV/V ↔ RS-232C port of CPU Unit (see note 1) or Serial Communications Board/Unit  <p>Note: 1. If the system is a Duplex CPU System, connect to the active CPU Unit. 2. We recommend the following configuration if the CX-Programmer is always connected and you want to avoid switching to the other CPU Unit when an error occurs.</p>  <p>Terminator ON +5 V must be supplied to the NT-AL001 at computer side.</p> | 2 m | Can be used for both peripheral bus and host link, and is equipped with an anti-static connector. | XW2Z-200S-CV |
| | | | 5 m | | XW2Z-500S-CV |
| | | | 2 m | Can be used for host link only. Cannot be used for peripheral bus. | XW2Z-200S-V |
| | | | 5 m | | XW2Z-500S-V |

Ordering Information

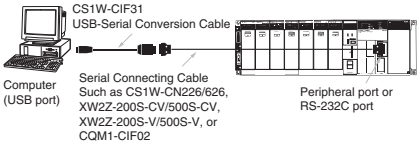

| Name | Specifications | | | | Model |
|---|---|---|--------------|--|------------|
| | Applicable computers | Connection configuration | Cable length | Remarks | |
| USB-Serial Conversion Cable (PC driver CD-ROM included)  Conforms to USB 2.0 Specifications. | IBM PC/AT or compatible computer (USB port) | IBM PC/AT or compatible computer ↔ CS1W-CIF31 ↔ CS1W-CN226/626 ↔ Peripheral port of CPU Unit (See note.)  Note: If the system is a Duplex CPU System, connect to the active CPU Unit. | 0.5 m | Can be used for both peripheral bus and host link. | CS1W-CIF31 |
| | | IBM PC/AT or compatible computer ↔ CS1W-CIF31 ↔ XW2Z-200S-CV/500S-CV ↔ CS1W-CN118 ↔ Peripheral port of CPU Unit | | Can be used for both peripheral bus and host link. | |
| | | IBM PC/AT or compatible computer ↔ CS1W-CIF31 ↔ XW2Z-200S-V/500S-V ↔ CS1W-CN118 ↔ Peripheral port of CPU Unit | | Can be used for host link only. Cannot be used for peripheral bus. | |
| | | IBM PC/AT or compatible computer ↔ CS1W-CIF31 ↔ XW2Z-200S-CV/500S-CV ↔ CS1W-CN118 ↔ RS-232C port of CPU Unit or Serial Communications Board/Unit | | Can be used for both peripheral bus and host link. | |
| | | IBM PC/AT or compatible computer ↔ CS1W-CIF31 ↔ XW2Z-200S-V/500S-V ↔ RS-232C port of CPU Unit or Serial Communications Board/Unit | | Can be used for host link only. Cannot be used for peripheral bus. | |

Note: Either of the serial communications modes listed in the following table can be used to connect CX-One Support Software (e.g., the CX-Programmer) to a CS1-series PLC.

| Serial communications mode | Features |
|----------------------------|--|
| Peripheral bus | This mode can provide high-speed communications, so this mode is normally used to connect when using CX-One component software such as the CX-Programmer. <ul style="list-style-type: none"> • Supports 1:1 connections only. • The Programming Device's baud rate can be detected automatically and matched. |
| Host Link (SYSWAY) | This is a general host computer communications protocol, which supports 1:1 and 1:N connections. <ul style="list-style-type: none"> • Host link operates at a slower speed than peripheral bus. • Host link supports 1:N connections as well as long-distance connections when RS-422A/RS-485 is used for a connection through a modem or optical adapter. |

Ordering Information

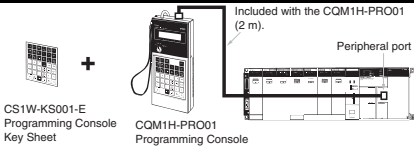
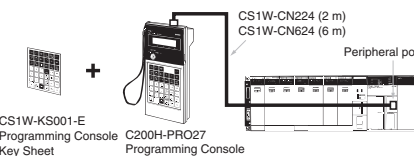
■ Programming Consoles

| Name | Specifications | Cable model (Separate item) | Connection configuration | Model |
|--|---|------------------------------------|--|---------------|
| Programming Console  | Can be connected to the CPU Unit's peripheral port only (see note). Cannot be connected to the RS-232C port. A CS1W-KS001-E Programming Console Key Sheet is required (sold separately). Note: If the system is a Duplex CPU System, connect to the active CPU Unit. | Not required (Cable included) |  | CQM1H-PRO01-E |
| | | CS1W-CN224: 2 m CS1W-CN624: 6 m |  | C200H-PRO27-E |
| Programming Console Key Sheet | For the following Programming Consoles: CQM1H-PRO01, C200H-PRO27, and CQM1-PRO01 | | | CS1W-KS001-E |
| Programming Console Connecting Cable  | For CQM1-PRO01 connection, Cable length: 0.05 m | | | CS1W-CN114 |
| | For C200H-PRO27 connection, Cable length: 2 m | | | CS1W-CN224 |
| | For C200H-PRO27 connection, Cable length: 6 m | | | CS1W-CN624 |



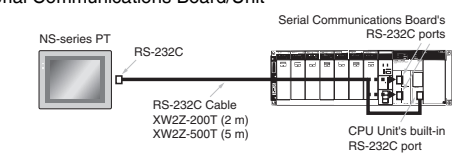
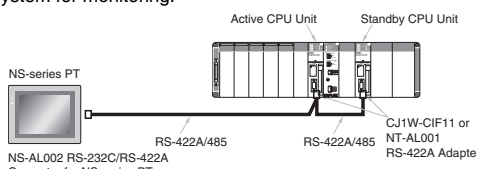



■ Connecting Cables for NS-series PTs

| Name | Specifications | | Model |
|---|---|--------------|-------------|
| | Connection configuration | Cable length | |
| Connecting Cables for NS-series PTs  | Connecting Cables between an NS-series PT and the RS-232C port of CPU Unit (see note 1) or Serial Communications Board/Unit  | 2 m | XW2Z-200T |
| | Note: 1. If the system is a Duplex CPU System, connect to the active CPU Unit. 2. We recommend the following configuration if the PT is always connected to a Duplex CPU System for monitoring.  | 5 m | |
| | Connecting Cables between an NS-series PT and the peripheral port of CPU Unit | | 2 m |
| | | 5 m | XW2Z-500T-2 |

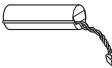
Ordering Information





Accessories and Maintenance Parts

| Name | Specifications | Model |
|--|--|-----------|
| Memory Cards  | Flash Memory, 128 MB | HMC-EF183 |
| | Memory Card Adapter (Adapts to a computer's PCMCIA card slot.) | HMC-AP001 |

| Name | Specifications | Model |
|--|--|--------------|
| Battery Set  | Battery for CS-series maintenance Note: <ol style="list-style-type: none"> 1. A battery is included with the CPU Unit as standard equipment. 2. The battery life is 5 years at an ambient temperature of 25°C, although the lifetime can be as short as 1.1 years under adverse temperature and power conditions. 3. Use a replacement battery that was manufactured within the last two years. | CS1W-BAT01 |
| I/O Terminal Cover  | Cover for 10-pin Terminal Blocks | C200H-COV11 |
| Connector Cover  | Protective cover for unused Power Supply Unit connector in CS1D Backplane | C500-COV01 |
| | Protective cover for unused CS-series Unit connector in Backplane | CV500-COV01 |
| Space Units  | For unused I/O slot spaces In the CS1D-BC□□(S) or CS1D-BI□□□ Backplanes | CS1W-SP001 |
| | For unused power supply slot spaces (same shape as PA207R) | CS1D-SP001 |
| | For unused power supply slot spaces (same shape as PD024) | CS1D-SP002 |
| Programming Console Mounting Bracket  | Use to mount a C200H-PRO27 Programming Console in a control panel. | C200H-ATT01* |
| Terminator  | Connect a Terminator to the last CS1D Long-distance Expansion Rack in each series (for use with the CS1W-IC102). Two Terminators are included with the CS1W-IC102 I/O Control Unit. | CV500-TER01 |
| RS-422A Converter | The RS-422A Converter converts RS-232C to RS-422A/RS-485 format. | CJ1W-CIF11 |
| RS-232C/RS-422A Link Adapter | One RS-232C port One RS-422 terminal block | NT-AL001 |

* Product no longer available to order.

DIN Track Mounting Accessories

| Name | Specifications | Model |
|--|---|-------------|
| DIN Track Mounting Bracket  | 1 set (package of 2 brackets) | C200H-DIN01 |
| DIN Track  | Track length: 50 cm Height: 7.3 mm | PFP-50N |
| | Track length: 1 m Height: 7.3 mm | PFP-100N |
| | Track length: 1 m Height: 16 mm | PFP-100N2 |
| End Plate  | Note: Order in lots of 10. | PFP-M |
| Spacer  | | PFP-S |

Ordering Information

■ NS-series Programmable Terminals

| Model name | Specifications | | | | Model number |
|---|--|------------------|-------------|------------------------------------|----------------|
| | Effective display area | Number of dots | Ethernet | Case color | |
| NS5-V2 (See note1.) | 5.7-inch TFT color | 320 × 240 dots | No | Ivory | NS5-SQ10-V2 |
| | | | | Black | NS5-SQ10B-V2 |
| | | | Yes | Ivory | NS5-SQ11-V2 |
| | Black | | | NS5-SQ11B-V2 | |
| | 5.7-inch High-luminance TFT color | | No | Ivory | NS5-TQ10-V2 |
| | | | | Black | NS5-TQ10B-V2 |
| Yes | | Ivory | NS5-TQ11-V2 | | |
| | Black | NS5-TQ11B-V2 | | | |
| NS8-V2 | 8.4-inch TFT | 640 × 480 dots | No | Ivory | NS8-TV00-V2 |
| | | | | Black | NS8-TV00B-V2 |
| | | | Yes | Ivory | NS8-TV01-V2 |
| | | | | Black | NS8-TV01B-V2 |
| NS10-V2 | 10.4-inch TFT | 640 × 480 dots | No | Ivory | NS10-TV00-V2 |
| | | | | Black | NS10-TV00B-V2 |
| | | | Yes | Ivory | NS10-TV01-V2 |
| | | | | Black | NS10-TV01B-V2 |
| NS12-V2 | 12.1-inch TFT | 800 × 600 dots | No | Ivory | NS12-TS00-V2 |
| | | | | Black | NS12-TS00B-V2 |
| | | | Yes | Ivory | NS12-TS01-V2 |
| | | | | Black | NS12-TS01B-V2 |
| NS15-V2 | 15-inch TFT | 1,024 × 768 dots | Yes | Silver | NS15-TX01S-V2 |
| | | | | Black | NS15-TX01B-V2 |
| NSH5-V2 (See note1.) Hand-held | 5.7-inch TFT | 320 × 240 dots | No | Black (Emergency stop button: Red) | NSH5-SQR10B-V2 |
| | | | | Black (Stop button: Gray) | NSH5-SQG10B-V2 |
| Cable (See note2.)  | Screen transfer cable for DOS/V (CX-Designer ↔ PT) | | | Length: 2 m | XW2Z-S002 |
| | USB-Serial Conversion Cable | | | Length: 0.5 m | CS1W-CIF31 |
| | USB relay cable | | | Length: 1 m | NS-USBEXT-1M |
| NSH5 Cables | RS-422A cable (loose wires + D-Sub 9-pin) | | | Length: 10 m | NSH5-422CW-10M |
| | RS-232C cable (loose wires + D-Sub 9-pin) | | | Length: 3 m | NSH5-232CW-3M |
| | RS-232C cable (loose wires + D-Sub 9-pin) | | | Length: 10 m | NSH5-232CW-10M |
| UL-compliant NSH5 Cable | RS-422A cable (loose wires) | | | Length: 10 m | NSH5-422UL-10M |
| | RS-232C cable (loose wires + relay cable) | | | Length: 3 m | NSH5-232UL-3M |
| | RS-232C cable (loose wires + relay cable) | | | Length: 10 m | NSH5-232UL-10M |
| PT-to-PLC Connecting Cable | PT connection: 9 pins | | | Length: 2 m | XW2Z-200T |
| | PLC connection: 9 pins | | | Length: 5 m | XW2Z-500T |
| | PT connection: 9 pins | | | Length: 2 m | XW2Z-200T-2 |
| | PLC peripheral port | | | Length: 5 m | XW2Z-500T-2 |

- Note:** 1. As of July 2008, the image memory has been increased to 60 MB.
 2. Use an OMRON USB Host Cable to connect an NS-series PT to a printer.
 Use a standard USB cable to connect the NS-series PT to a PictBridge-compatible printer.

NS-Runtime

| Model name | Specifications | Media | Model number | |
|------------|--|-------------|--------------|------------|
| NS-Runtime | NS-Runtime Installer, manual PDF, hardware key (See note.) | 1 license | CD | NS-NSRCL1 |
| | | 3 licenses | | NS-NSRCL3 |
| | | 10 licenses | | NS-NSRCL10 |

Note: A hardware key (USB dongle) is required to run NS-Runtime.

Read and Understand this Catalog

Please read and understand this catalog before purchasing the products. Please consult your OMRON representative if you have any questions or comments.

Warranty and Limitations of Liability

WARRANTY

OMRON's exclusive warranty is that the products are free from defects in materials and workmanship for a period of one year (or other period if specified) from date of sale by OMRON.

OMRON MAKES NO WARRANTY OR REPRESENTATION, EXPRESS OR IMPLIED, REGARDING NON-INFRINGEMENT, MERCHANTABILITY, OR FITNESS FOR PARTICULAR PURPOSE OF THE PRODUCTS. ANY BUYER OR USER ACKNOWLEDGES THAT THE BUYER OR USER ALONE HAS DETERMINED THAT THE PRODUCTS WILL SUITABLY MEET THE REQUIREMENTS OF THEIR INTENDED USE. OMRON DISCLAIMS ALL OTHER WARRANTIES, EXPRESS OR IMPLIED.

LIMITATIONS OF LIABILITY

OMRON SHALL NOT BE RESPONSIBLE FOR SPECIAL, INDIRECT, OR CONSEQUENTIAL DAMAGES, LOSS OF PROFITS, OR COMMERCIAL LOSS IN ANY WAY CONNECTED WITH THE PRODUCTS, WHETHER SUCH CLAIM IS BASED ON CONTRACT, WARRANTY, NEGLIGENCE, OR STRICT LIABILITY.

In no event shall the responsibility of OMRON for any act exceed the individual price of the product on which liability is asserted.

IN NO EVENT SHALL OMRON BE RESPONSIBLE FOR WARRANTY, REPAIR, OR OTHER CLAIMS REGARDING THE PRODUCTS UNLESS OMRON'S ANALYSIS CONFIRMS THAT THE PRODUCTS WERE PROPERLY HANDLED, STORED, INSTALLED, AND MAINTAINED AND NOT SUBJECT TO CONTAMINATION, ABUSE, MISUSE, OR INAPPROPRIATE MODIFICATION OR REPAIR.

Application Considerations

SUITABILITY FOR USE

OMRON shall not be responsible for conformity with any standards, codes, or regulations that apply to the combination of the product in the customer's application or use of the product.

At the customer's request, OMRON will provide applicable third party certification documents identifying ratings and limitations of use that apply to the products. This information by itself is not sufficient for a complete determination of the suitability of the products in combination with the end product, machine, system, or other application or use.

The following are some examples of applications for which particular attention must be given. This is not intended to be an exhaustive list of all possible uses of the products, nor is it intended to imply that the uses listed may be suitable for the products:

- Outdoor use, uses involving potential chemical contamination or electrical interference, or conditions or uses not described in this document.
- Nuclear energy control systems, combustion systems, railroad systems, aviation systems, medical equipment, amusement machines, vehicles, safety equipment, and installations subject to separate industry or government regulations.
- Systems, machines, and equipment that could present a risk to life or property.
Please know and observe all prohibitions of use applicable to the products.

NEVER USE THE PRODUCT FOR AN APPLICATION INVOLVING SERIOUS RISK TO LIFE OR PROPERTY WITHOUT ENSURING THAT THE SYSTEM AS A WHOLE HAS BEEN DESIGNED TO ADDRESS THE RISKS, AND THAT THE OMRON PRODUCT IS PROPERLY RATED AND INSTALLED FOR THE INTENDED USE WITHIN THE OVERALL EQUIPMENT OR SYSTEM.

PROGRAMMABLE PRODUCTS

OMRON shall not be responsible for the user's programming of a programmable product, or any consequence thereof.

Disclaimers

CHANGE IN SPECIFICATIONS

Product specifications and accessories may be changed at any time based on improvements and other reasons. Consult with your OMRON representative at any time to confirm actual specifications of purchased products.

DIMENSIONS AND WEIGHTS

Dimensions and weights are nominal and are not to be used for manufacturing purposes, even when tolerances are shown.

PERFORMANCE DATA

Performance data given in this catalog is provided as a guide for the user in determining suitability and does not constitute a warranty. It may represent the result of OMRON's test conditions, and the users must correlate it to actual application requirements. Actual performance is subject to the OMRON *Warranty and Limitations of Liability*.

Note: Do not use this document to operate the Unit.

OMRON Corporation Industrial Automation Company
Tokyo, JAPAN

Contact: www.ia.omron.com

Regional Headquarters

OMRON EUROPE B.V.

Wegalaan 67-69-2132 JD Hoofddorp
The Netherlands
Tel: (31)2356-81-300/Fax: (31)2356-81-388

OMRON ELECTRONICS LLC

One Commerce Drive Schaumburg,
IL 60173-5302 U.S.A.
Tel: (1) 847-843-7900/Fax: (1) 847-843-7787

OMRON ASIA PACIFIC PTE. LTD.

No. 438A Alexandra Road # 05-05/08 (Lobby 2),
Alexandra Technopark,
Singapore 119967
Tel: (65) 6835-3011/Fax: (65) 6835-2711

OMRON (CHINA) CO., LTD.

Room 2211, Bank of China Tower,
200 Yin Cheng Zhong Road,
PuDong New Area, Shanghai, 200120, China
Tel: (86) 21-5037-2222/Fax: (86) 21-5037-2200

Authorized Distributor:

© OMRON Corporation 2009-2020 All Rights Reserved.
In the interest of product improvement,
specifications are subject to change without notice.

CSM_9_9
Cat. No. P051-E1-11

Printed in Japan
0820 (0500)