

REVISIONS					
REV	ECO	DESCRIPTION	DATE	BY	APPR
A1		RELEASE DRAWING	17/AUG/22	SULLEN	TOMMY

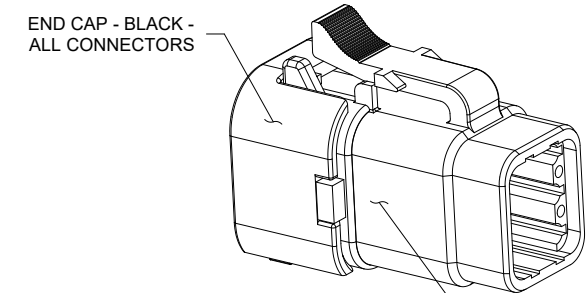
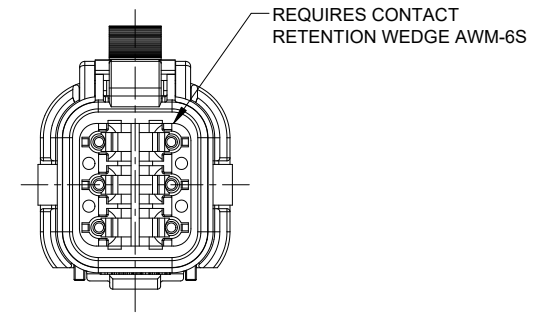
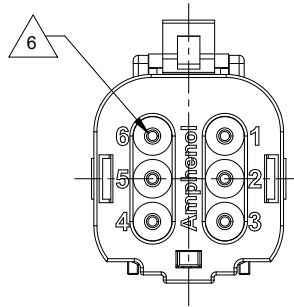
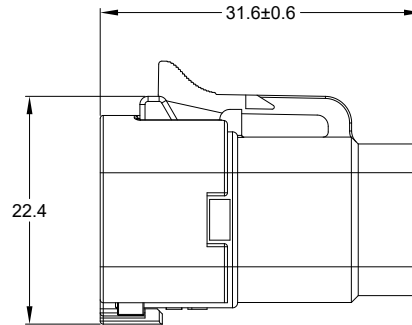
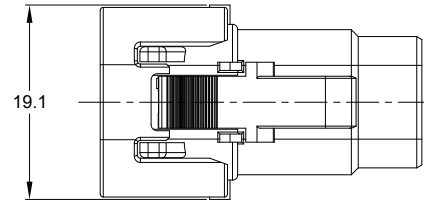

STANDARD MOLDED COLOR IS GREY.
ADDITIONAL COLORS SHOWN IN PART NUMBER CHART ARE AVAILABLE VIA SPECIAL ORDER.

NOTES: UNLESS OTHERWISE SPECIFIED

- MATERIAL:
HOUSING: THERMOPLASTIC; COLOR: SEE PART NUMBER CHART
END CAP: THERMOPLASTIC; COLOR: BLACK
SEAL: SILICONE RUBBER; COLOR: RED
- MODIFICATIONS: SNAP FIT END CAP
- SPECIFICATIONS:
 - CURRENT RATING: 7.5 AMPS
 - OPERATING TEMPERATURE: -55°C TO +125°C
 - DIELECTRIC WITHSTANDING VOLTAGE: LESS THAN 2 MILLIAMPS CURRENT LEAKAGE @ 1500 VOLTS AC.
 - INSULATION RESISTANCE: 1000 MEGOHMS MIN @ 25°C
 - MOISTURE RESISTANCE:
IP68 (IM OF WATER FOR A PERIOD OF 24 HOURS, MATED CONDITION)
IP69K (MATED CONDITION)
 - MATING CYCLE DURABILITY: 100 CYCLES
 - RoHS COMPLIANT
- MATING PART: ATM04-6P* RECEPTACLE
(* = MODIFICATIONS AND COLORS)
- ALL DIMENSIONS ARE FOR REFERENCE USE ONLY

△ CONTACT SIZE AND REAR SEAL WIRE RANGE:

CONTACT SIZE	MIN. INSUL O.D.	MAX. INSUL O.D.	TYPICAL WIRE RANGE
20	1.35 mm (.053 in)	3.05 mm (.120 in)	16 - 22 AWG (1.5 - 0.35 mm ²)

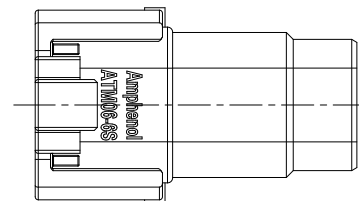



PART NUMBER CHART	
COLOR	PART NUMBER
GREY	ATM06-6S-SF01
BLACK	ATM06-6S-SF01BLK

QUANTITY	SEE PART NUMBER CHART	DESCRIPTION	ITEM
MATERIALS LIST			
UNLESS OTHERWISE SPECIFIED 1) All dimensions are in metric (mm). 2) Tolerances are as follows: 1 PL DEC ±0.30 2 PL DEC ±0.15 3 PL DEC ±0.08 Fractions ±1/64 Angles ±1° 3) Note reference = △		SIGNATURES DRAWN: SULLEN, ZHANG CHECKED: ORION LI ENGINEER: APPROVAL: TOMMY XIE CUSTOMER:	DATE 17/AUG/22 18/AUG/22 18/AUG/22
MATERIAL SPECIFICATIONS: WEIGHT: 6.6g		Amphenol Sine Systems - www.amphenol-sine.com 44724 Morley Drive Clinton Township, MI 48036	
PROCESS SPECIFICATIONS:		6 POS, PLUG, SOCKET, ATM SERIES, SNAP FIT	
NEXT ASSY:		THIS DRAWING IS SUPPLIED FOR INFORMATION ONLY. DESIGN FEATURES, SPECIFICATIONS AND PERFORMANCE DATA SHOWN HEREON ARE THE PROPERTY OF THE AMPHENOL CORPORATION. NO RIGHTS OF REPRODUCTION ARE IMPLIED. ALL DIMENSIONS ARE SUBJECT TO NORMAL MANUFACTURING VARIATIONS.	
SCALE: NONE		SIZE: B C- DWG NO.: ATM06-6S-SF01XXX REVISION: A1	SHEET 1 OF 1





TITLE: 6 POS, PLUG, SOCKET, ATM SERIES, SNAP FIT END CAP
 DWG NO.: ATM06-6S-SF01XXX
 REV: A1
 SH: 1
 OF: 1

ATM Series™ - Contact Size 20 Options

Machined Contacts, Sockets & Pins				
Part Number	Description	Size	AWG	Type
AT60-010-2031	Male Contact - Pin, Gold-plated	20	16-18	Machined
AT62-005-20141	Female Contact - Socket, Gold-plated	20	16-18	Machined
AT60-010-20141	Male Contact - Pin, Nickel-plated	20	16-18	Machined
AT62-005-2031	Female Contact - Socket, Nickel-plated	20	16-18	Machined
AT60-202-2031	Male Contact - Pin, Gold-plated	20	20-22	Machined
AT62-201-2031	Female Contact - Socket, Gold-plated	20	20-22	Machined
AT60-202-20141	Male Contact - Pin, Nickel-plated	20	20-22	Machined
AT62-201-20141	Female Contact - Socket, Nickel-plated	20	20-22	Machined

Tooling - Machined Contacts		
Part	Part Number	Description
	CA-5D12	Universal Hand Crimp Tool, Size 12/16/20 (Machined contacts only)
	CA-5E12	Pneumatic Crimp Tool, Size 12/16/20 (Machined contacts only)

Contact Removal Tools		
Part	Part Number	Description
	ATRT-100	Used for removal of contacts for A Series™ products
	AT11-240-2005	Contact Removal Tool, Plastic, Size 20

Sealing Plugs		
Part	Part Number	Description
	AT13-204-2005	Sealing Plug, Size 20, White
	AT13-204-2005-SR	Sealing Plug, Size 20, SR01 Series, Black
	ATM13-217-2005	Locking Sealing Plug, Size 20, Grey
	ATM13-217-2005-SR	Locking Sealing Plug, Size 20, SR01 Series, Blue

Stamped & Formed Contacts, Sockets & Pins				
Part Number	Description	Size	AWG	Type
AT60-20-0144	Male Contact - Pin, Gold-plated	20	16-22	Stamped & Formed
AT62-20-0144	Female Contact - Socket, Gold-plated	20	16-22	Stamped & Formed
AT60-20-0244	Male Contact - Socket, Gold-plated	20	16-22	Stamped & Formed
AT62-20-0244	Female Contact - Socket, Gold-plated	20	16-22	Stamped & Formed
AT60-20-0122	Male Contact - Pin, Nickel-plated	20	16-22	Stamped & Formed
AT62-20-0122	Female Contact - Socket, Nickel-plated	20	16-22	Stamped & Formed
AT60-20-0222	Male Contact - Socket, Nickel-plated	20	16-22	Stamped & Formed
AT62-20-0222	Female Contact - Socket, Nickel-plated	20	16-22	Stamped & Formed
AT60-20-0277	Male Contact - Socket, Tin-plated	20	16-22	Stamped & Formed
AT62-20-0277	Female Contact - Socket, Tin-plated	20	16-22	Stamped & Formed
AT60-20-0422	Male Contact - Socket, Nickel-plated	20	20-22	Stamped & Formed
AT62-20-0444	Female Contact - Socket, Gold-plated	20	20-22	Stamped & Formed

Tooling - Stamped & Formed Contacts		
Part	Part Number	Description
	MFx-3974	Crimp Die - Size 20 (S&F contacts only)
	MFx-3976	Crimp Die - Size 20 (S&F contacts only) 20-22AWG -04XX Series
	MFx-3978	Crimp Die - Size 20 (S&F contacts only) 20-22AWG -02XX Series
	ATT-20-00	Hand Crimp Tool - Size 20, 20AWG (S&F contacts only)