

Three Phase Superior Performance EMI Filter – Bookshelf Type Single Stage WYE Configuration

DATASHEET

Bookshelf design for motor drive applications requiring minimum space and convenient installation with superior performance at significant interference levels



Typical Circuit Diagram

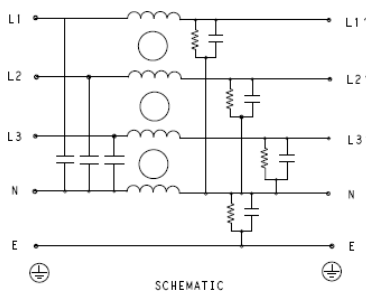

Specifications

Electrical Characteristics

Maximum Continuous Operating Voltage	440/520VAC
Current Ratings	7A to 150A @40°C, Din Mount 7A to 100A @40°C
Operating Frequency	50/60Hz
High Potential Test Voltage -440VAC	Line to Ground 2632VDC for 1 Minute Line to Line 1892VDC for 1 Minute
High Potential Test Voltage -520VAC	Line to Ground 2856VDC for 1 Minute Line to Line 2236VDC for 1 Minute
Overload Capability	135% of Rated current for 15 minutes

Functional Characteristics

Operating Temperature Range	-25°C to +85°C
Climatic Category	25/85/21
Termination	Shock Proof
Flammability corresponding to	UL 94 V-0

Reference Standards

Design Corresponding to	UL 60939-3 and CSA 22.2 No.8-13
-------------------------	---------------------------------

Approvals & Compliance

UL Recognised

CSA Certified *

*30th June 2021



Features

- 3 Phase filters for Drives/invertors
- Bookshelf Design
- Chassis mounting with neutral

Applications

- Industrial Automation
- HVAC
- CNC Machines
- Robotics

KEP-BS SERIES



Selection Table – Standard Version

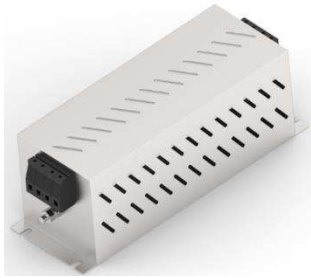

TE Ordering Number	Catalog Number	Rated Current @40°C	Rated Voltage @40°C	Leakage Current (mA)	Termination 	Weight (Kgs)
2-1609968-7	7KEPS10ABSW	7A	440 VAC	5	41	0.8
3-1609968-0	16KEPS10ABSW	16A	440 VAC	5	41	0.9
3-1609968-1	30KEPS10ABSW	30A	440 VAC	5	41	1.2
3-1609968-2	42KEPS10ABSW	42A	440 VAC	6	10	1.2
3-1609968-3	55KEPS10ABSW	55A	440 VAC	6	10	1.6
3-1609968-4	75KEPS10ABSW	75A	440 VAC	6	16	2
3-1609968-5	100KEPS10ABSW	100A	440 VAC	11	25	2.2
3-1609968-6	125KEPS10ABSW	120A	440 VAC	11	50	4
3-1609968-7	150KEPS10ABSW	150A	440 VAC	11	50	5
5-1609968-7	7KEPS10BBSW	7A	520 VAC	5	41	0.8
6-1609968-0	16KEPS10BBSW	16A	520 VAC	5	41	0.9
6-1609968-1	30KEPS10BBSW	30A	520 VAC	5	41	1.2
6-1609968-2	42KEPS10BBSW	42A	520 VAC	6	10	1.2
6-1609968-3	55KEPS10BBSW	55A	520 VAC	6	10	1.6
6-1609968-4	75KEPS10BBSW	75A	520 VAC	6	16	2
6-1609968-5	100KEPS10BBSW	100A	520 VAC	11	25	2.2
6-1609968-6	125KEPS10BBSW	120A	520 VAC	11	50	4
6-1609968-7	150KEPS10BBSW	150A	520 VAC	11	50	5

KEP-BS SERIES



Selection Table – Din Rail Mount



NEW

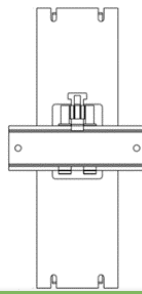

HORIZONTAL MOUNT

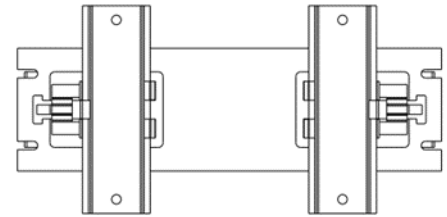

Note: Din Rail not supplied

VERTICAL MOUNT

TE Part Number	Catalog Number	Din Type	Rated Current @40°C	Rated Voltage @40°C	Leakage Current (mA)	Termination	Weight (Kgs)
9-1609968-3	7KEPS10ABSWHM	HORIZONTAL	7A	440 VAC	5	41	0.9
9-1609968-4	16KEPS10ABSWHM	HORIZONTAL	16A	440 VAC	5	41	1
9-1609968-5	30KEPS10ABSWHM	HORIZONTAL	30A	440 VAC	5	41	1.3
9-1609968-6	42KEPS10ABSWHM	HORIZONTAL	42A	440 VAC	6	10	1.3
9-1609968-7	7KEPS10ABSWVM	VERTICAL	7A	440 VAC	5	41	1.8
9-1609968-8	16KEPS10ABSWVM	VERTICAL	16A	440 VAC	5	41	1.4
9-1609968-9	30KEPS10ABSWVM	VERTICAL	30A	440 VAC	5	41	1.4
7-1609969-0	42KEPS10ABSWVM	VERTICAL	42A	440 VAC	6	10	1.8
7-1609969-1	55KEPS10ABSWHM	HORIZONTAL	55A	440 VAC	6	10	2.2
7-1609969-2	75KEPS10ABSWHM	HORIZONTAL	75A	440 VAC	6	16	2.4
7-1609969-3	100KEPS10ABSWHM	HORIZONTAL	100A	440 VAC	11	25	3.2
8-1609969-5	7KEPS10BBSWHM	HORIZONTAL	7A	520 VAC	5	41	0.9
8-1609969-6	16KEPS10BBSWHM	HORIZONTAL	16A	520 VAC	5	41	1
8-1609969-7	30KEPS10BBSWHM	HORIZONTAL	30A	520 VAC	5	41	1.3
8-1609969-8	42KEPS10BBSWHM	HORIZONTAL	42A	520 VAC	6	10	1.3
8-1609969-9	7KEPS10BBSWVM	VERTICAL	7A	520 VAC	5	41	1.8
9-1609969-0	16KEPS10BBSWVM	VERTICAL	16A	520 VAC	5	41	1.4
9-1609969-1	30KEPS10BBSWVM	VERTICAL	30A	520 VAC	5	41	1.4
9-1609969-2	42KEPS10BBSWVM	VERTICAL	42A	520 VAC	6	10	1.8
9-1609969-3	55KEPS10BBSWHM	HORIZONTAL	55A	520 VAC	6	10	2.2
9-1609969-4	75KEPS10BBSWHM	HORIZONTAL	75A	520 VAC	6	16	2.4
9-1609969-5	100KEPS10BBSWHM	HORIZONTAL	100A	520 VAC	11	25	3.2

Connectors Cross Section

	41	10	16	25	50
Wire Section (mm ²)	4mm ²	10 mm ²	16 mm ²	25 mm ²	50 mm ²
Wire Section (AWG)	12AWG	8 AWG	6 AWG	4 AWG	1/0 AWG
Wire Stripping	Max 10mm	max 13.5 mm	max 17 mm	max 17 mm	max 20 mm
Max Recommended Torque	0.5 Nm / 4.5 in.lbs	1.2 Nm / 10.8 in.lbs	2÷2.2 Nm / 18÷19.8 in.lbs	2 Nm / 18 in.lbs	6 Nm / 54 in.lbs

Insertion Loss (Typical) – Measured in Closed 50Ω System

Common Mode 50Ω / 50Ω

		Frequency in MHz								
		0.01	0.05	0.15	0.5	1	3	5	10	30
Current Rating	7A	22	18	48	60	70	65	58	31	11
	16A	20	25	56	64	75	70	60	31	11
	30A	21	23	35	61	67	50	43	37	19
	42A	35	42	55	54	52	48	34	24	10
	55A	32	40	55	56	52	48	34	24	12
	75A	30	35	48	60	64	57	30	22	15
	100A	24	24	29	56	46	50	54	23	12
	125A	25	25	32	55	45	32	28	22	12
	150A	24	25	31	50	41	30	26	21	13

Differential Mode 50Ω / 50Ω

		Frequency in MHz								
		0.01	0.05	0.15	0.5	1	3	5	10	30
Current Rating	7A	24	22	63	50	67	60	56	70	50
	16A	32	40	63	60	70	65	60	50	60
	30A	28	29	38	75	67	59	48	21	24
	42A	32	40	50	65	62	68	62	40	18
	55A	32	41	52	68	62	68	56	40	16
	75A	27	32	41	56	68	60	49	38	19
	100A	17	20	23	42	40	52	58	20	20
	125A	44	45	49	48	40	31	25	17	16
	150A	42	43	47	48	41	30	24	18	18

Common Mode Insertion Loss (Typical in dB – refer to Table above)

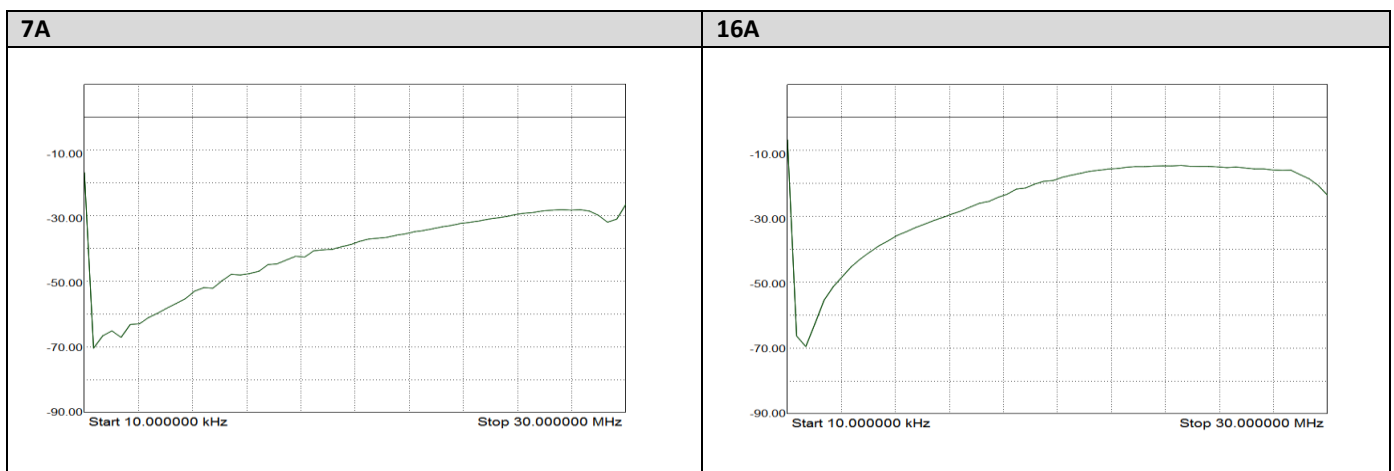

KEP-BS SERIES

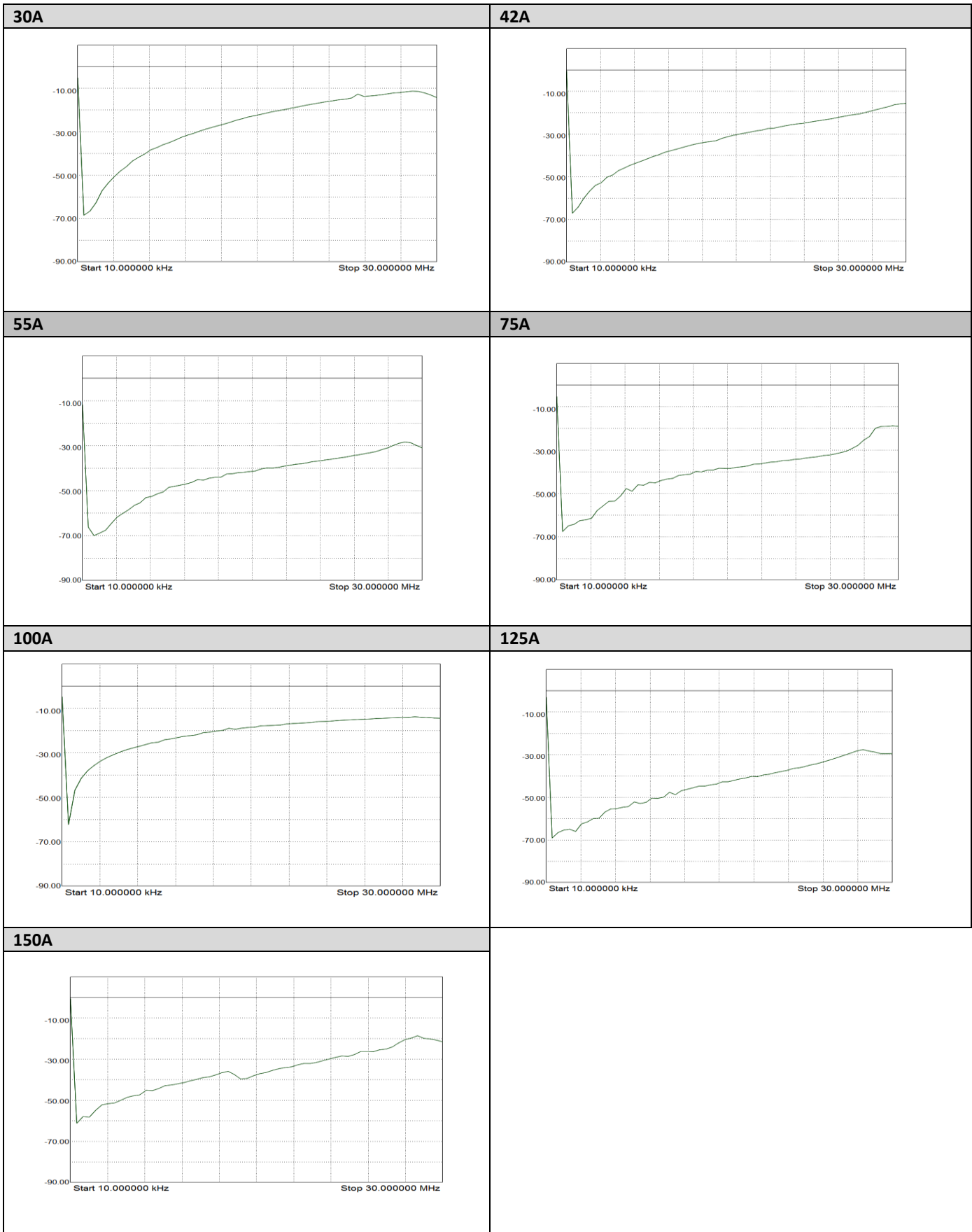

KEP-BS SERIES



Case Dimensions – Standard Version

7A Shock Proof Type	16A Shock Proof Type
30A Shock Proof Type	42 Shock Proof Type
55A Shock Proof Type	75A Shock Proof Type

KEP-BS SERIES

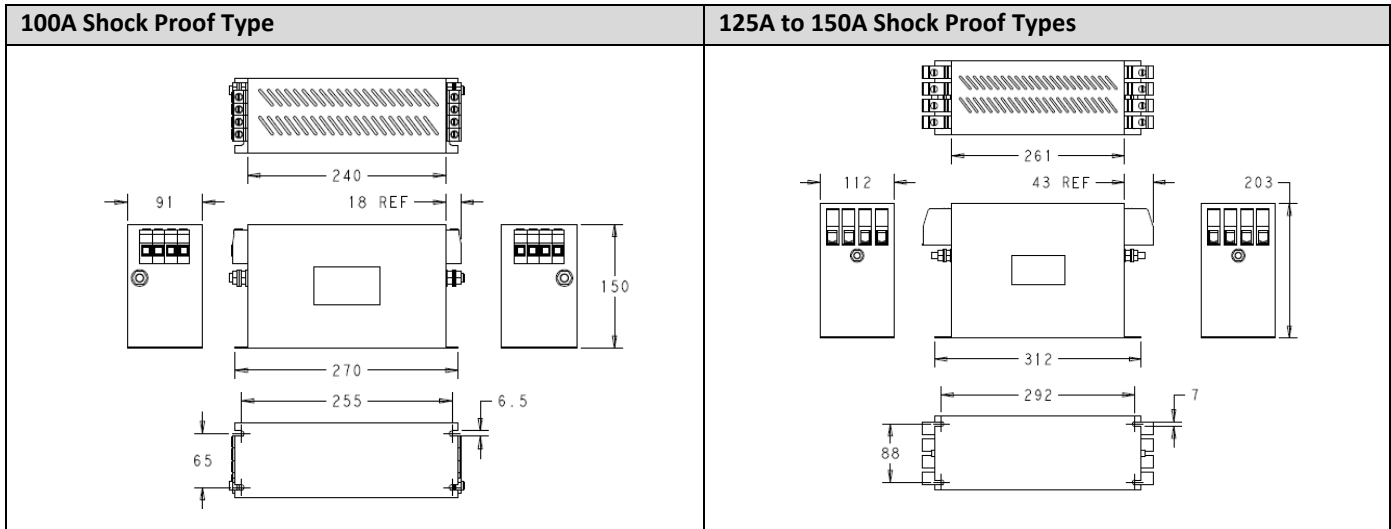

All dimensions in mm; Tolerances according: ISO2768-m

Case Dimensions – Din Rail Mount

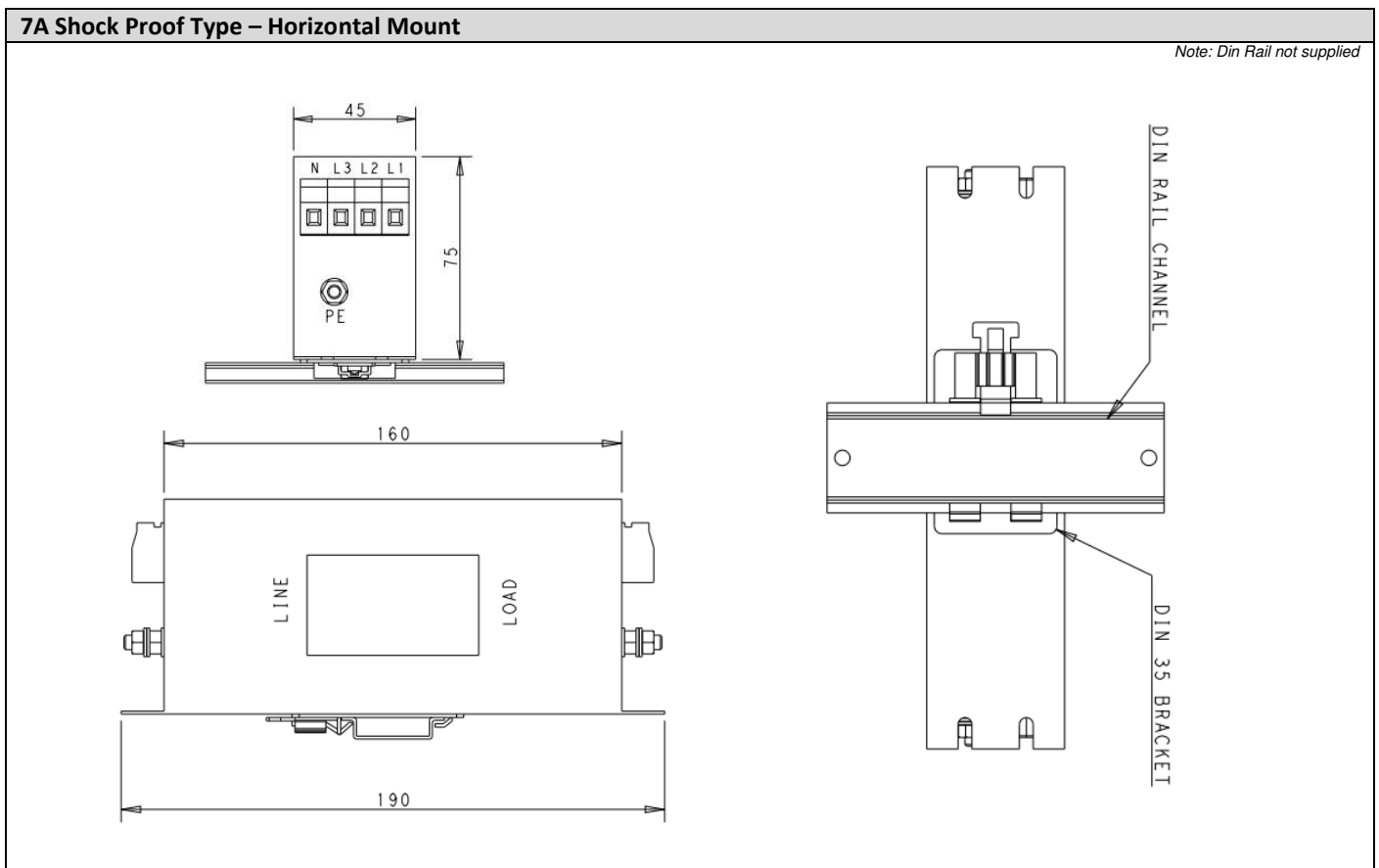

KEP-BS SERIES



7A Shock Proof Type – Vertical Mount

Note: Din Rail not supplied

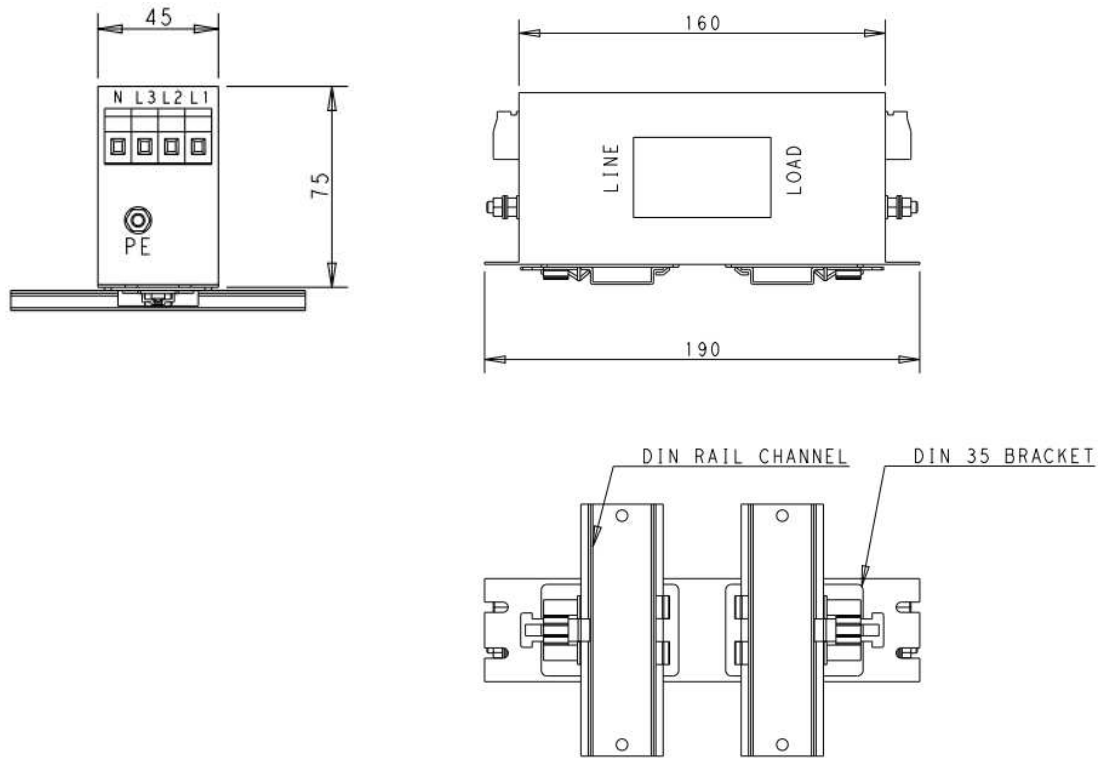

16A Shock Proof Type – Horizontal Mount

Note: Din Rail not supplied

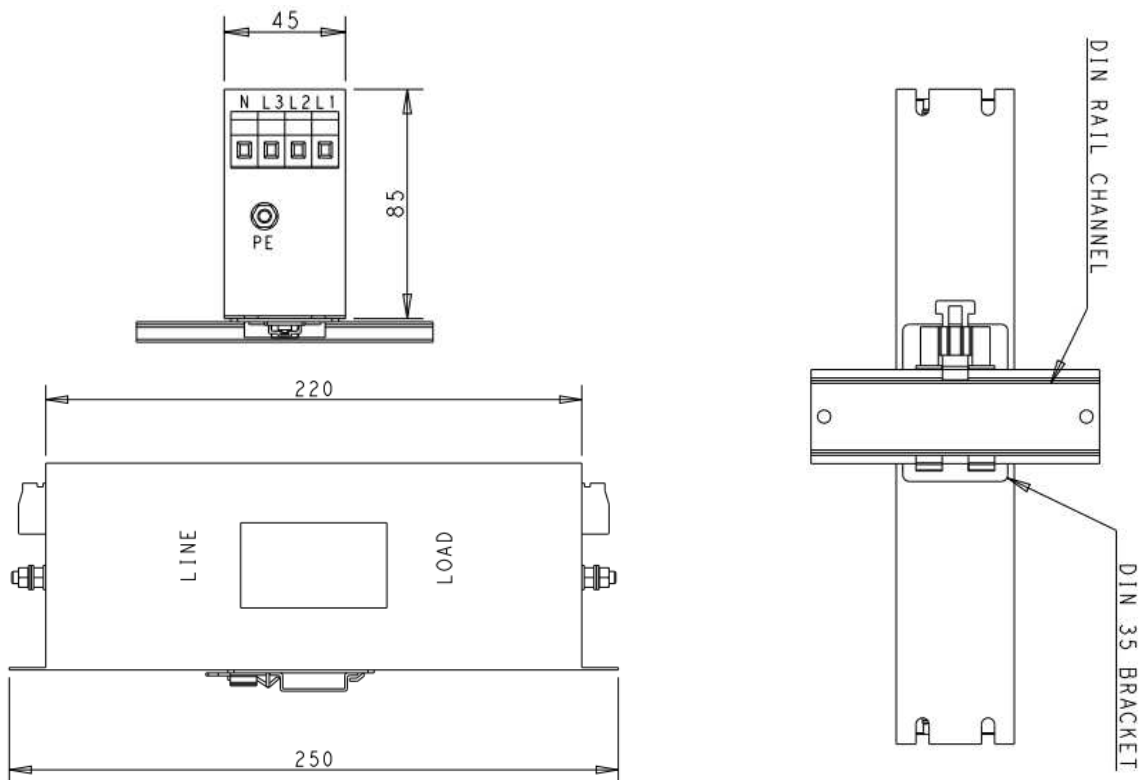

KEP-BS SERIES



16A Shock Proof Type – Vertical Mount

Note: Din Rail not supplied

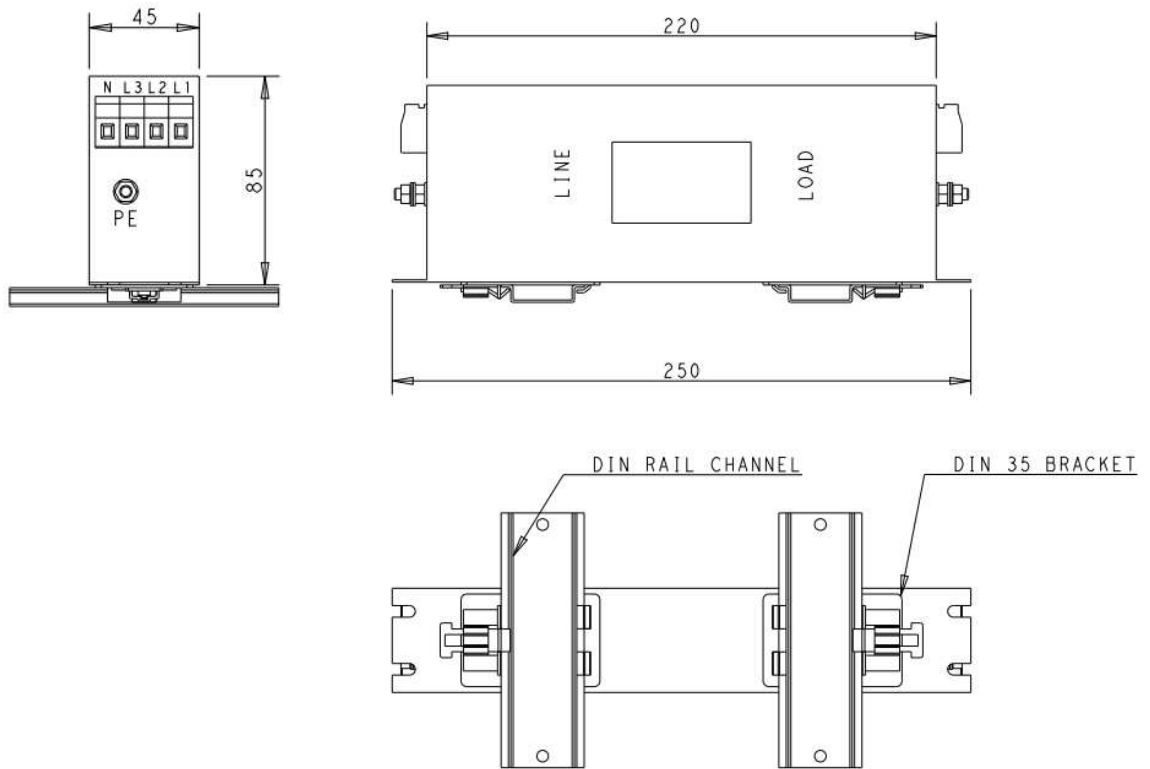

30A Shock Proof Type – Horizontal Mount

Note: Din Rail not supplied

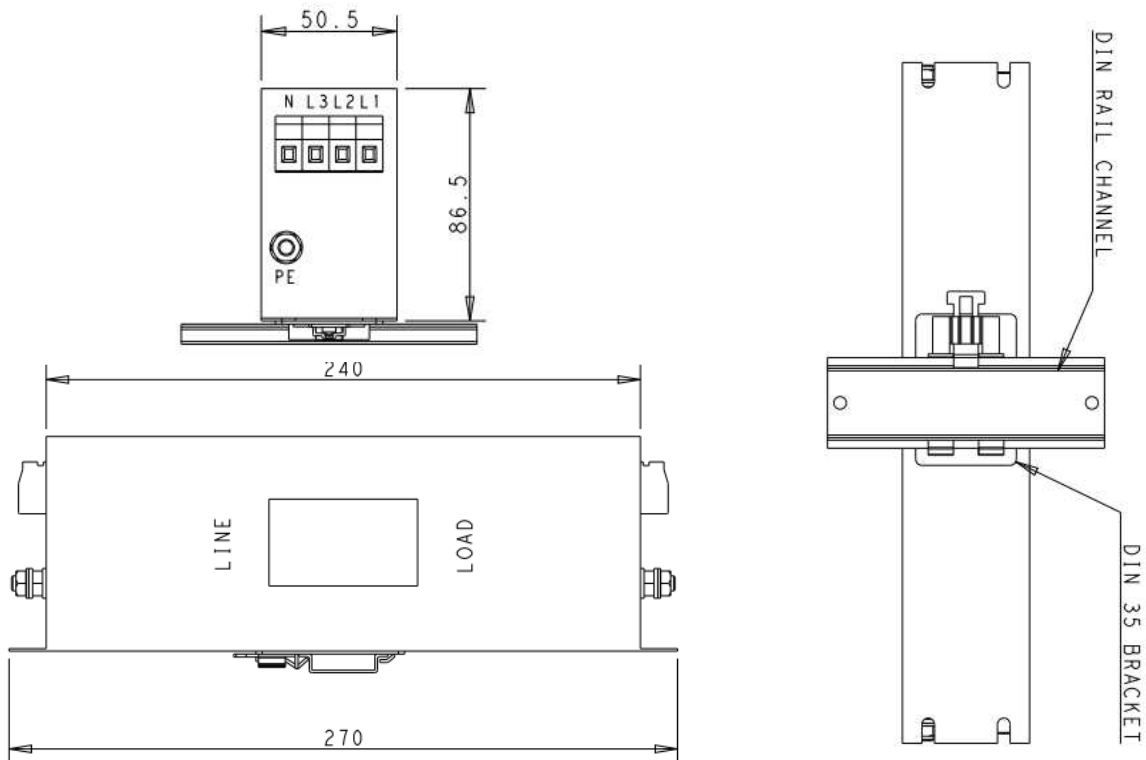

KEP-BS SERIES



30A Shock Proof Type – Vertical Mount

Note: Din Rail not supplied

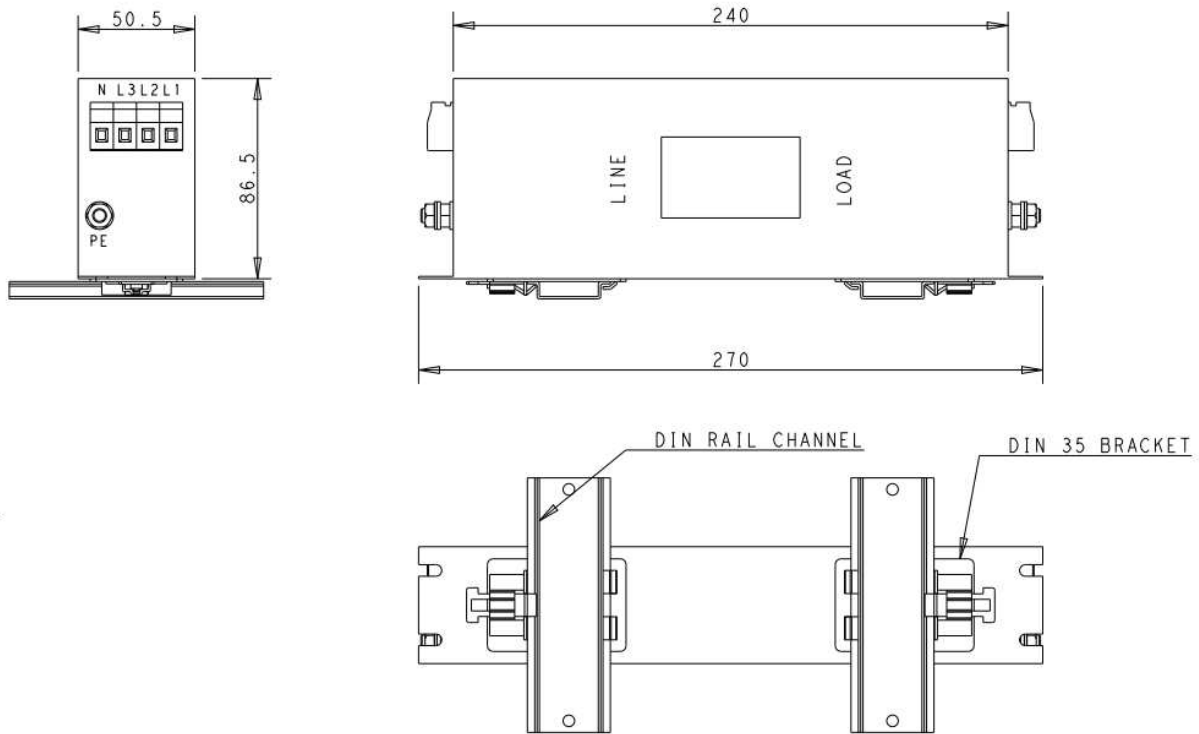

42A Shock Proof Type – Horizontal Mount

Note: Din Rail not supplied

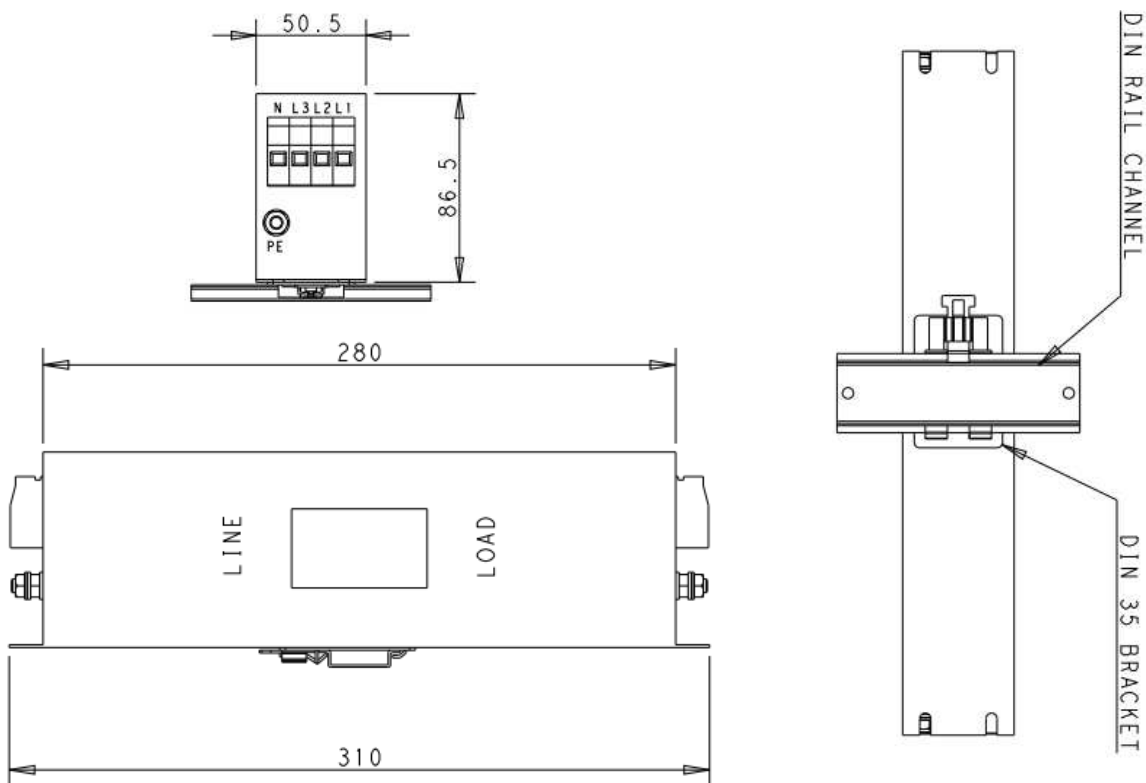

KEP-BS SERIES



42A Shock Proof Type – Vertical Mount

Note: Din Rail not supplied

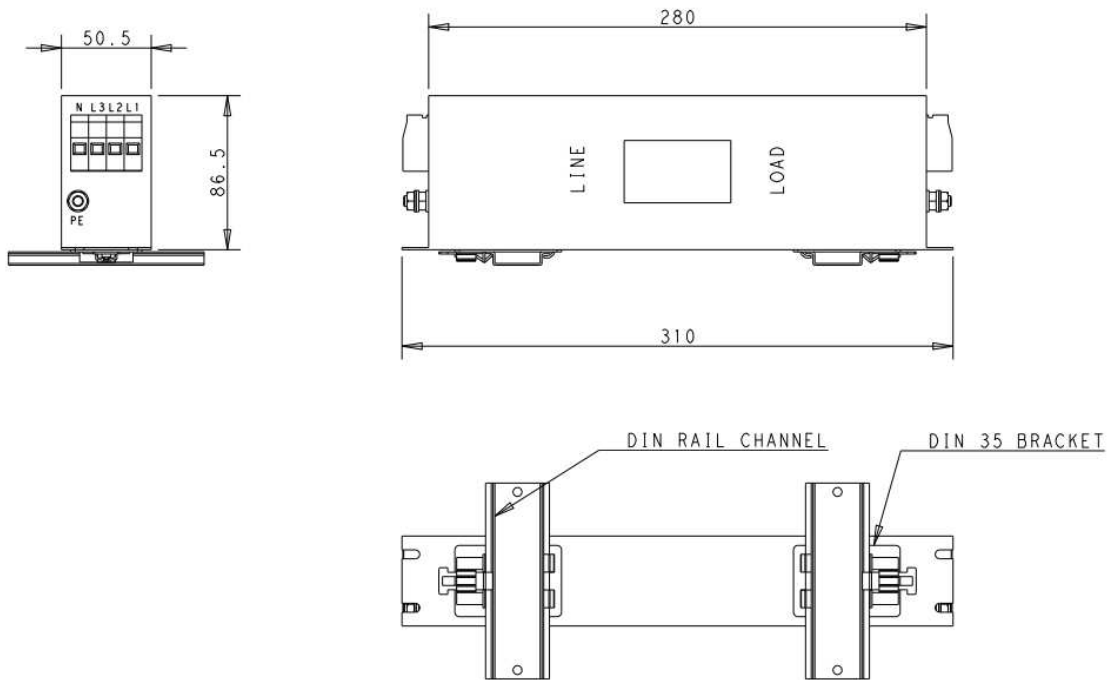

55A Shock Proof Type – Horizontal Mount

Note: Din Rail not supplied

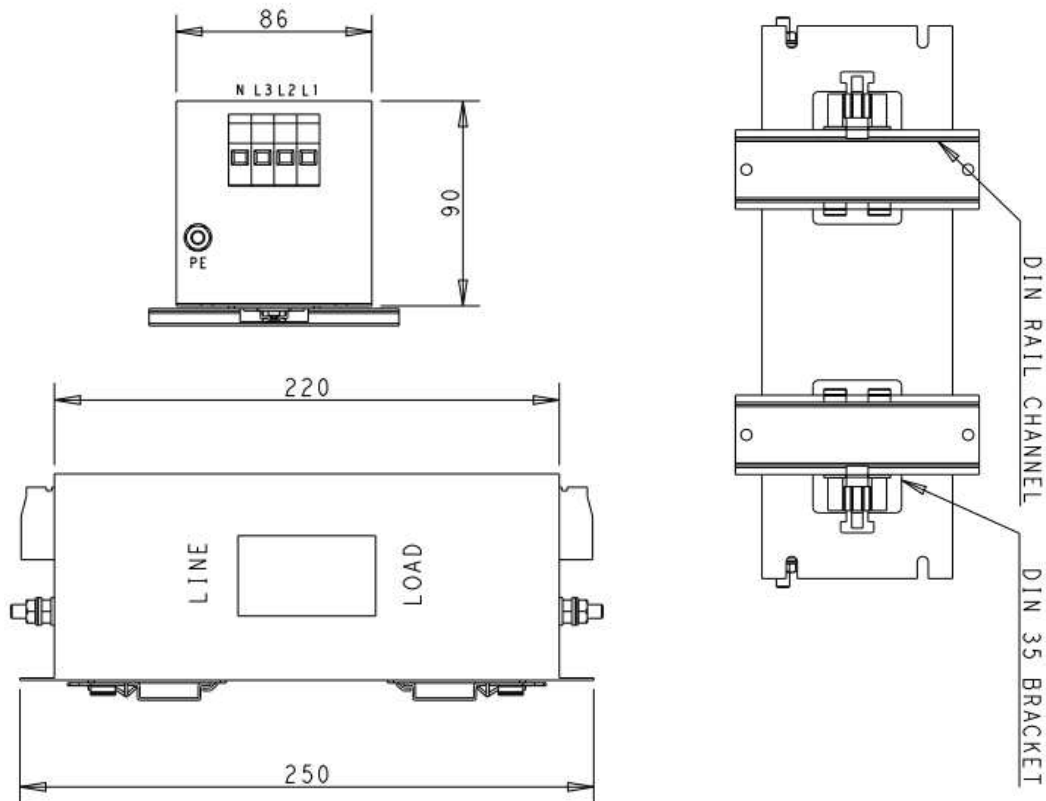

KEP-BS SERIES



75A Shock Proof Type – Horizontal Mount

Note: Din Rail not supplied

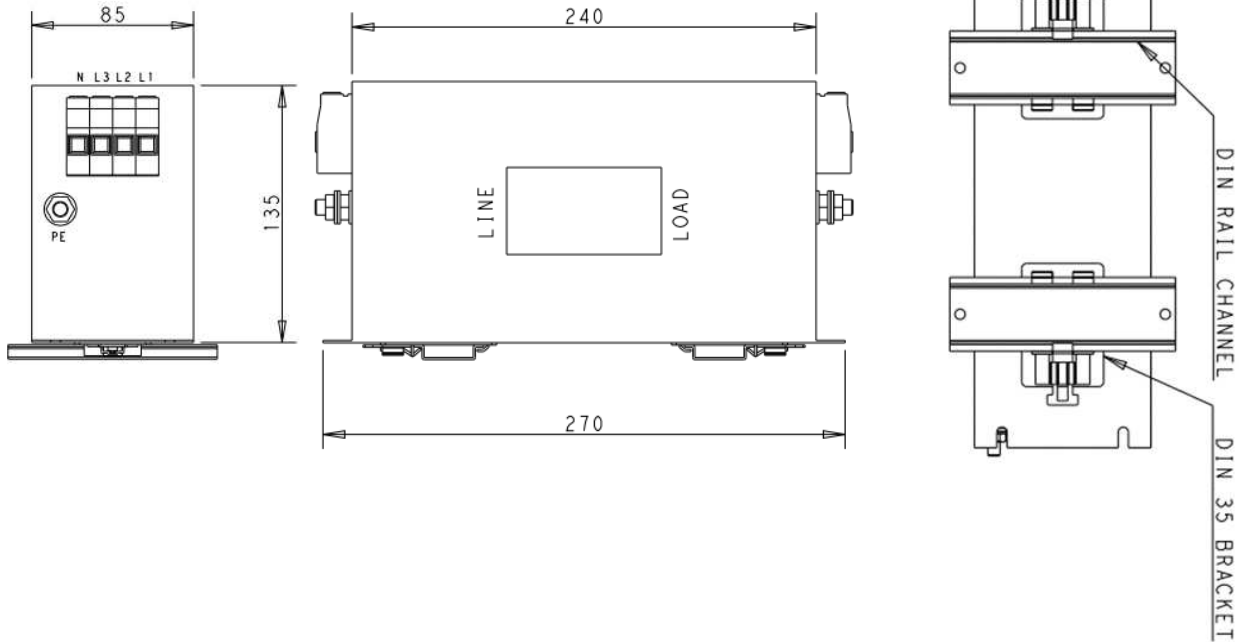

100A Shock Proof Type – Horizontal Mount

Note: Din Rail not supplied

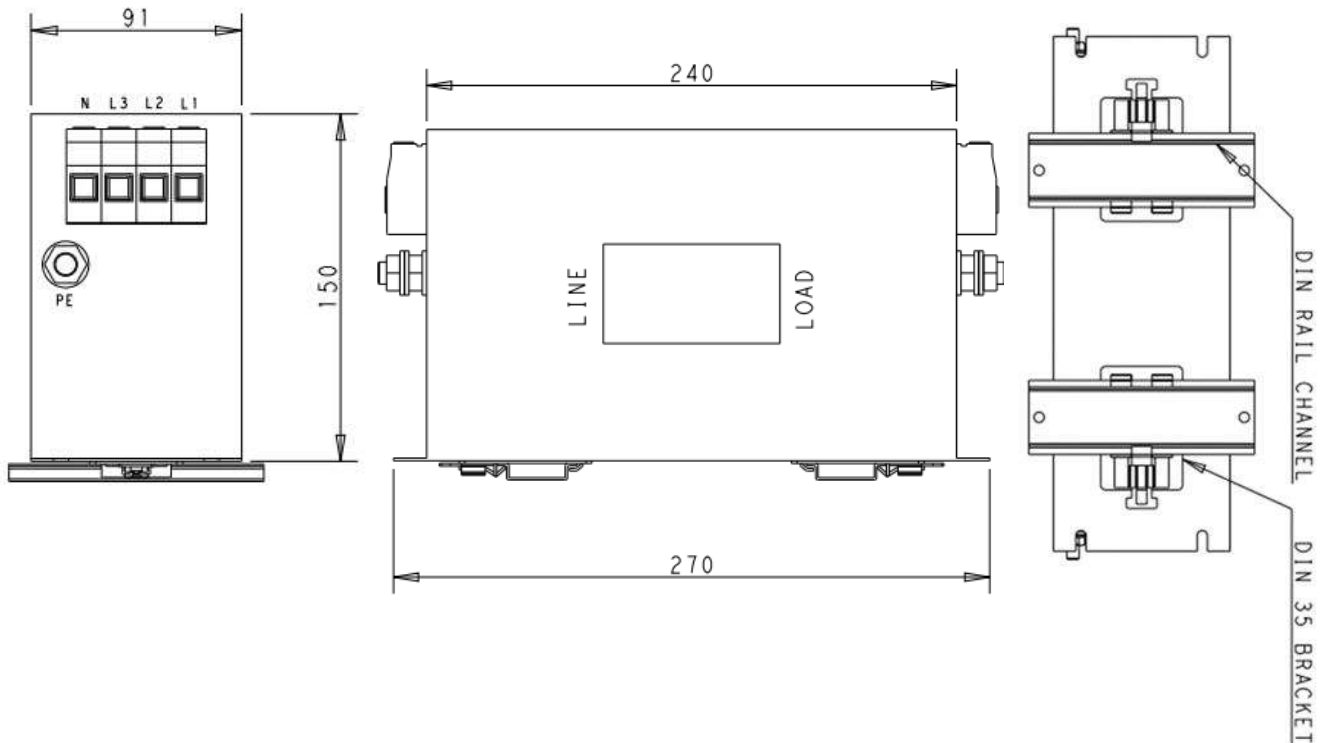

KEP-BS SERIES



All dimensions in mm; Tolerances according: ISO2768-m

How to Order

