

RECOMMENDED PCB LAYOUT(CONNECTOR SIDE VIEW)
THICKNESS=1.6mm MIN. TOLERANCE:±0.05

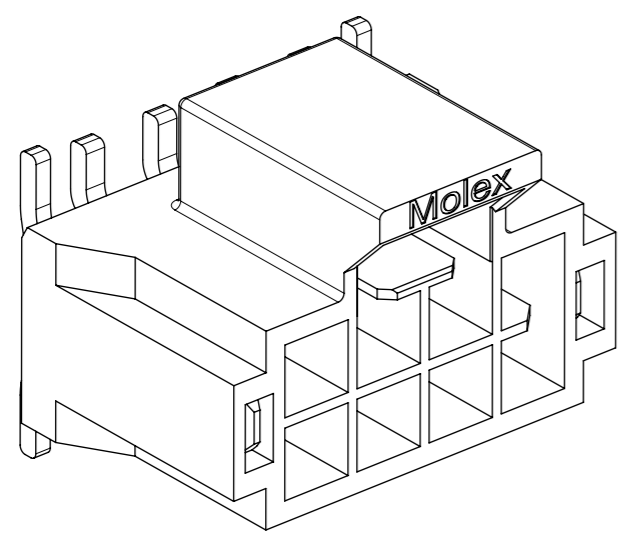

WITHOUT MYLAR

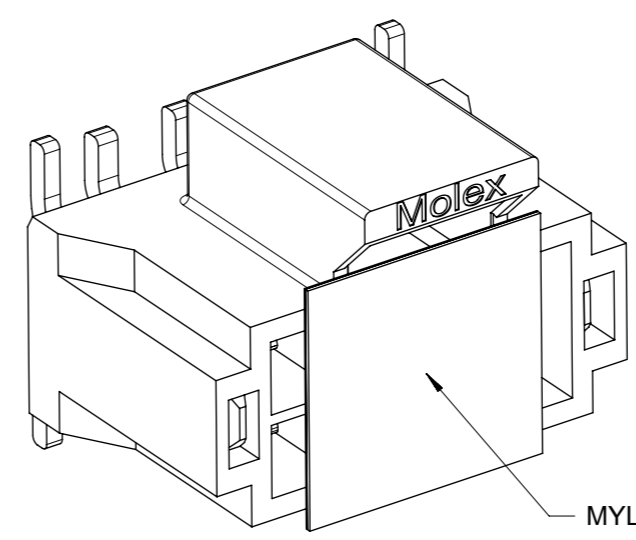

WITH MYLAR
DELIVER TO CUSTOMER

QUALITY SYMBOLS ▽A = 0 ▽E = 0 ▽F = 0 ▽ = 0 ▽C = 0 ▽X = 0 ▽ = 0 ▽ = 0	THIS DRAWING CONTAINS INFORMATION THAT IS PROPRIETARY TO MOLEX ELECTRONIC TECHNOLOGIES, LLC AND SHOULD NOT BE USED WITHOUT WRITTEN PERMISSION										
	RE-MASTER IN ECTR EC NO: 625433 DRWN: GLLI CHK'D: YXZHENG APPR: YXZHENG	2019/10/10	2019/10/10	2019/10/10	GENERAL TOLERANCES (UNLESS SPECIFIED)		DIMENSION UNITS	SCALE			
					ANGULAR TOL ± 3.0 °		mm	5:1			
					4 PLACES	±	DRWN BY	DATE	SD DRAWING FOR NANO-FIT HEADER OF SMT VERTICAL DUAL		
					3 PLACES	±	WJHUO	2014/10/30			
					2 PLACES	± 0.2	CHK'D BY	DATE			
				1 PLACE	± 0.3	APPR BY	DATE	PRODUCT CUSTOMER DRAWING			
				0 PLACES	±	AYIN	2015/03/12	SERIES	MATERIAL NUMBER	CUSTOMER	
				DRAFT WHERE APPLICABLE MUST REMAIN WITHIN DIMENSIONS		DRAWING SIZE	THIRD ANGLE PROJECTION	105429	SEE TABLE	GENERAL MARKET	
						A3		DOCUMENT NUMBER	DOC TYPE	DOC PART	SHEET NUMBER
							SD-105429-001	PSD	000	1 OF 4	

PART NUMBER	DIM. A	DIM. B	DIM. C	CKT SIZE	PLATING	LUBE
105429-1104	8.23	2.50	6.11	4	TIN	
105429-1106	10.73	5.00	8.61	6		
105429-1108	13.23	7.50	11.11	8		
105429-1110	15.73	10.00	13.61	10		
105429-1112	18.23	12.50	16.11	12		
105429-1114	20.73	15.00	18.61	14		
105429-1116	23.23	17.50	21.11	16		
105429-1204	8.23	2.50	6.11	4		
105429-1206	10.73	5.00	8.61	6		
105429-1208	13.23	7.50	11.11	8		
105429-1210	15.73	10.00	13.61	10		
105429-1212	18.23	12.50	16.11	12		
105429-1214	20.73	15.00	18.61	14		
105429-1216	23.23	17.50	21.11	16		
105429-1304	8.23	2.50	6.11	4	GOLD 0.76	
105429-1306	10.73	5.00	8.61	6		
105429-1308	13.23	7.50	11.11	8		
105429-1310	15.73	10.00	13.61	10		
105429-1312	18.23	12.50	16.11	12		
105429-1314	20.73	15.00	18.61	14		
105429-1316	23.23	17.50	21.11	16		
105429-1404	8.23	2.50	6.11	4		
105429-1406	10.73	5.00	8.61	6		
105429-1408	13.23	7.50	11.11	8		
105429-1410	15.73	10.00	13.61	10		
105429-1412	18.23	12.50	16.11	12		
105429-1414	20.73	15.00	18.61	14		
105429-1416	23.23	17.50	21.11	16		

COLOR: BLACK

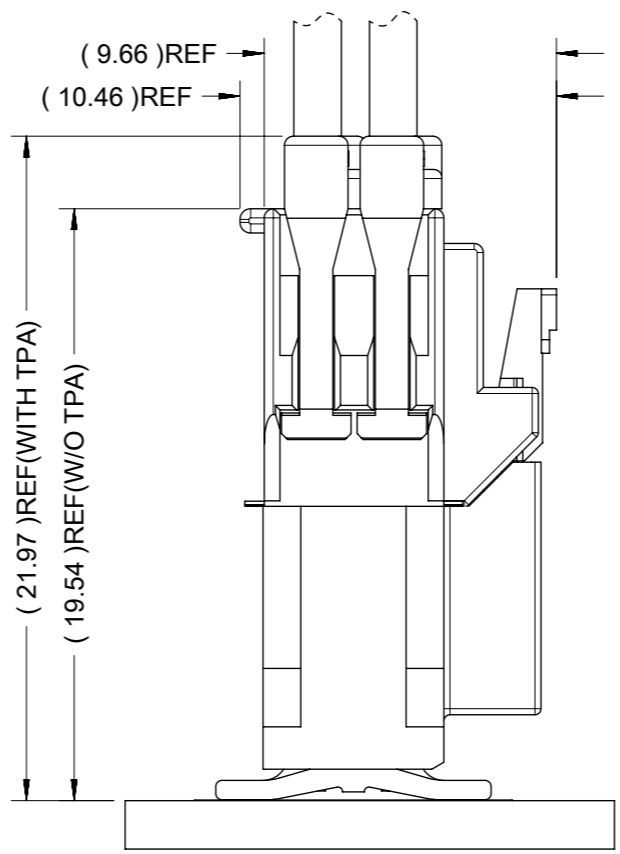

PART NUMBER	DIM. A	DIM. B	DIM. C	CKT SIZE	PLATING	LUBE
105429-2104	8.23	2.50	6.11	4	TIN	
105429-2106	10.73	5.00	8.61	6		
105429-2108	13.23	7.50	11.11	8		
105429-2110	15.73	10.00	13.61	10		
105429-2112	18.23	12.50	16.11	12		
105429-2114	20.73	15.00	18.61	14		
105429-2116	23.23	17.50	21.11	16		
105429-2204	8.23	2.50	6.11	4		
105429-2206	10.73	5.00	8.61	6		
105429-2208	13.23	7.50	11.11	8		
105429-2210	15.73	10.00	13.61	10		
105429-2212	18.23	12.50	16.11	12		
105429-2214	20.73	15.00	18.61	14		
105429-2216	23.23	17.50	21.11	16		
105429-2304	8.23	2.50	6.11	4	GOLD 0.76	
105429-2306	10.73	5.00	8.61	6		
105429-2308	13.23	7.50	11.11	8		
105429-2310	15.73	10.00	13.61	10		
105429-2312	18.23	12.50	16.11	12		
105429-2314	20.73	15.00	18.61	14		
105429-2316	23.23	17.50	21.11	16		
105429-2404	8.23	2.50	6.11	4		
105429-2406	10.73	5.00	8.61	6		
105429-2408	13.23	7.50	11.11	8		
105429-2410	15.73	10.00	13.61	10		
105429-2412	18.23	12.50	16.11	12		
105429-2414	20.73	15.00	18.61	14		
105429-2416	23.23	17.50	21.11	16		

COLOR: NATURAL

NOTES FOR ALL PARTS

1> MATERIAL:
HOUSING: LCP, UL 94V-0.
TERMINAL: BRASS.
SOLDER CLIP: BRASS.

2> PLATING FINISHED:
TERMINAL:
CONTACT AREA:
a. REFLOWED MATTE TIN 0.76 MICRONS MIN; b. GOLD 0.38 MICRONS MIN; c. GOLD 0.76 MICRONS MIN.
SOLDER AREA: TIN 0.76 MICRONS MINIMUM.
UNDER PLATING NICKEL 1.25 MICRONS MINIMUM.
SOLDER CLIP: TIN 2.5 MICRONS MINIMUM; UNDER PLATING NICKEL 1.25 MICRONS MINIMUM.

3> PRODUCT SPECIFICATION: PS-105405-001.
4> PACKAGE: TAPE REEL, DETAILS REFER TO DRAWING 1054291000-PK.
5> ALL COMPONENTS AND PRODUCT COMPLIANT TO RoHS DIRECTIVE 2011/65/EU AND ELV DIRECTIVE 2000/53/EC.
6> PRODUCT MATE WITH SERIES OF 105308(RECEPTACLE), 105300(CRIMP TERMINAL).
7> PARTS CONFORM TO CLASS 'B' REQUIREMENTS OF COSMETIC SPECIFICATION PS-45499-002.

THIS DRAWING CONTAINS INFORMATION THAT IS PROPRIETARY TO MOLEX ELECTRONIC TECHNOLOGIES, LLC AND SHOULD NOT BE USED WITHOUT WRITTEN PERMISSION													
QUALITY SYMBOLS ▽A = 0 ▽E = 0 ▽B = 0 ▼ = 0 ▽C = 0 ⊗ = 0 ■ = 0 ▽ = 0		RE-MASTER IN ECTR EC NO: 625433 DRWN: GLLI CHK'D: YXZHENG APPR: YXZHENG		GENERAL TOLERANCES (UNLESS SPECIFIED) ANGULAR TOL ± 3.0 ° 4 PLACES ± 3 PLACES ± 2 PLACES ± 0.2 1 PLACE ± 0.3 0 PLACES ±		DIMENSION UNITS: mm SCALE: 5:1 DRWN BY: WJHUO DATE: 2014/10/30 CHK'D BY: DATE: APPR BY: AYIN DATE: 2015/03/12				SD DRAWING FOR NANO-FIT HEADER OF SMT VERTICAL DUAL		PRODUCT CUSTOMER DRAWING	
DRAFT WHERE APPLICABLE MUST REMAIN WITHIN DIMENSIONS		DRAWING SIZE: A3 THIRD ANGLE PROJECTION		SERIES: 105429 MATERIAL NUMBER: SEE TABLE CUSTOMER: GENERAL MARKET		DOCUMENT NUMBER: SD-105429-001 DOC TYPE: PSD DOC PART: 000 SHEET NUMBER: 3 OF 4							
RELEASE STATUS: P1 RELEASE DATE: 2019/10/10 06:03:14													

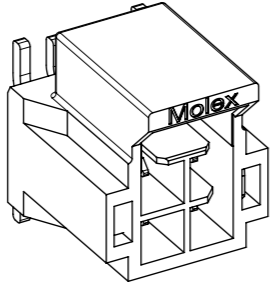
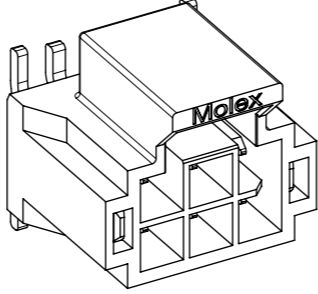
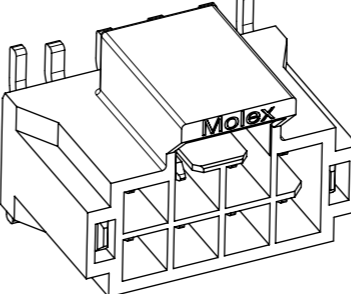
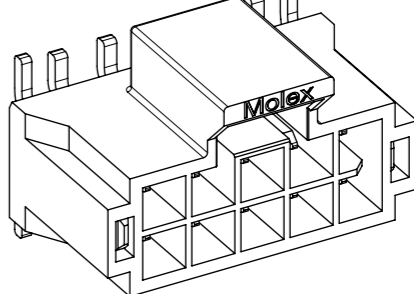
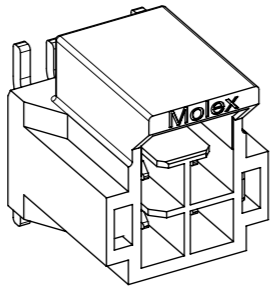
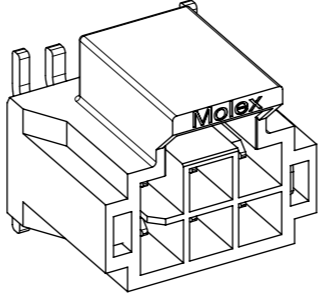
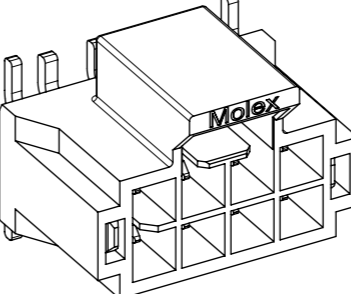
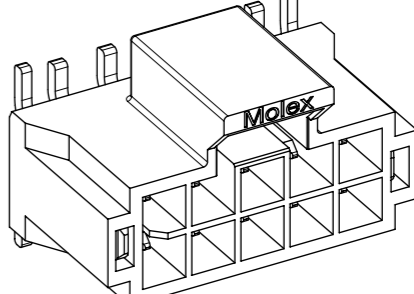
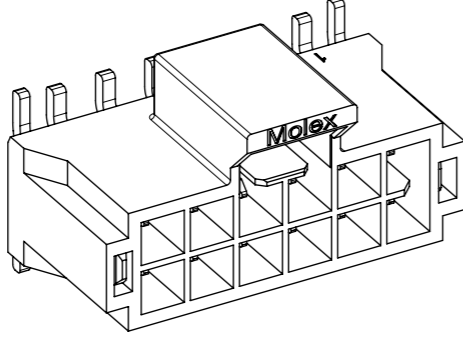
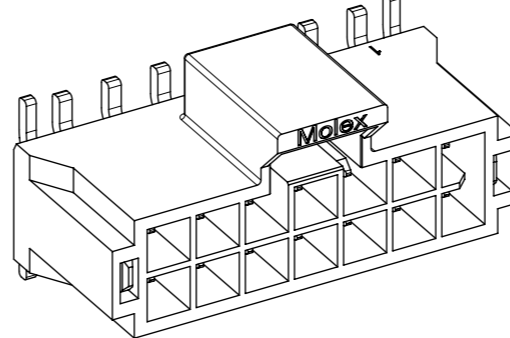
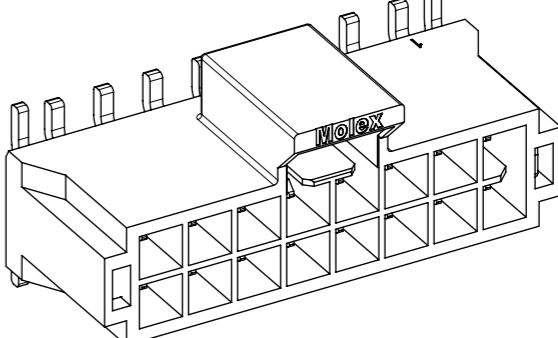
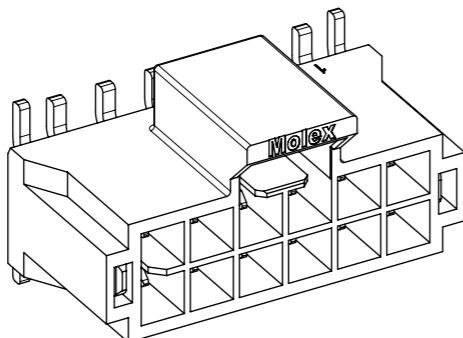
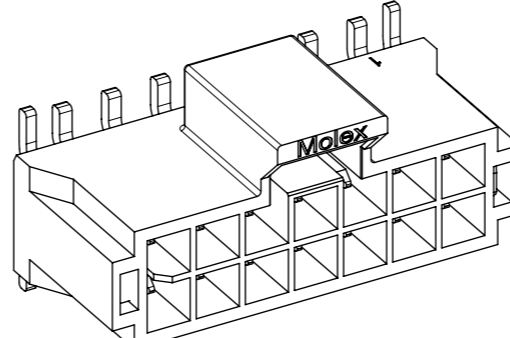
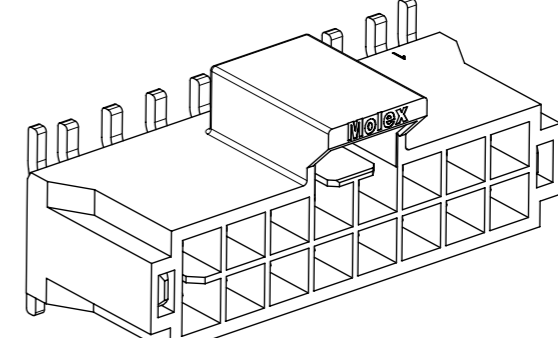
	4 CKT	6 CKT	8 CKT	10 CKT
BLACK				
NATURAL				
	12 CKT	14 CKT		16 CKT
BLACK				
NATURAL				

THIS DRAWING CONTAINS INFORMATION THAT IS PROPRIETARY TO MOLEX ELECTRONIC TECHNOLOGIES, LLC AND SHOULD NOT BE USED WITHOUT WRITTEN PERMISSION											
QUALITY SYMBOLS □ = 0 ▽ = 0 ▽ = 0 ▽ = 0 ▽ = 0 ▽ = 0 ▽ = 0 ▽ = 0 ▽ = 0 ▽ = 0 ▽ = 0 ▽ = 0		2019/10/10 2019/10/10 2019/10/10 2019/10/10		RE-MASTER IN ECTR EC NO: 625433 DRWN: GLLI CHK'D: YXZHENG APPR: YXZHENG		GENERAL TOLERANCES (UNLESS SPECIFIED) ANGULAR TOL ± 3.0 ° 4 PLACES ± 3 PLACES ± 2 PLACES ± 0.2 1 PLACE ± 0.3 0 PLACES ± DRAFT WHERE APPLICABLE MUST REMAIN WITHIN DIMENSIONS		DIMENSION UNITS: mm SCALE: 3:1 DRWN BY: RMV02 DATE: 2016/01/14 CHK'D BY: DATE: APPR BY: AYIN DATE: 2017/05/15 DRAWING SIZE: A3 THIRD ANGLE PROJECTION		 SD DRAWING FOR NANO-FIT HEADER OF SMT VERTICAL DUAL PRODUCT CUSTOMER DRAWING SERIES: 105429 MATERIAL NUMBER: CUSTOMER: GENERAL MARKET DOCUMENT NUMBER: SD-105429-001 DOC TYPE: PSD DOC PART: 000 SHEET NUMBER: 4 OF 4	