

**Data sheet | Item number: 281-612/281-417**

2-conductor fuse terminal block; with pivoting fuse holder; with blown fuse indication by neon lamp; 230 V; for DIN-rail 35 x 15 and 35 x 7.5; 4 mm<sup>2</sup>; CAGE CLAMP®; 4,00 mm<sup>2</sup>; gray

[www.wago.com/281-612/281-417](http://www.wago.com/281-612/281-417)



**i** Picture differs from the item.

Color: 

**Data**

**Electrical data**

**Ratings per IEC/EN**

Ratings per	IEC/EN 60947-7-3
Ratings (note)	Electrical ratings are given by the fuse and blown fuse indication.
Nominal voltage (III/3)	800 V
Rated impulse voltage (III/3)	8 kV

Subject to changes. Please also observe the further product documentation!

WAGO GmbH & Co. KG  
Hansastr. 27  
32423 Minden  
Phone: +49571 887-0 | Fax: +49571 887-169  
Email: [info.de@wago.com](mailto:info.de@wago.com) | Web: [www.wago.com](http://www.wago.com)

Do you have any questions about our products?  
We are always happy to take your call at +49 (571) 887-44222.



Rated current	10 A
Note (rated current)	Leakage current in case of a blown fuse: Neon lamp < 0.4 mA
Operation status indicator	230 V
Legend (ratings)	(III / 3) $\triangleq$ Overvoltage category III / Pollution degree 3

## Power loss

Power loss (max.) $P_{I(max)}$ (note)	When selecting glass cartridge fuses, make sure that the maximum power loss listed below is not exceeded. The power loss is determined according to IEC or EN 60947-7-3/VDE 0611-6 at 23°C. The temperature rise of the terminal block must be checked according to their application and mounting. Higher ambient temperatures represent an additional impact on miniature fuses. Therefore, in such applications, the rated current must be reduced if necessary. More details are available from the manufacturers.
Power loss $P_I$ max. overload and short-circuit protection (individual arrangement)	2.5 W
Power loss $P_I$ max. overload and short-circuit protection (group arrangement)	1.6 W
Power loss $P_I$ max. short-circuit protection (individual arrangement)	4 W
Power loss $P_I$ max. short-circuit protection (group arrangement)	4 W

## General

Fuse receptacle	pivoting
Fuse type	Cylindrical fuse; 5 x 25 mm

## Connection data

Connection points	2
Total number of potentials	2
Number of levels	1

## Connection 1

Connection technology	CAGE CLAMP®
Actuation type	Operating tool
Connectable conductor materials	Copper Aluminum
Connectable conductor materials (note)	

Subject to changes. Please also observe the further product documentation!



### Terminating Aluminum Conductors

WAGO spring clamp terminal blocks are suitable for solid aluminum conductors up to 4 mm<sup>2</sup>/12 AWG if WAGO "Alu-Plus" Contact Paste 249-130 is used for termination.

#### "Alu-Plus" Contact Paste Advantages:

- Automatically destroys the oxide film during clamping.
- Prevents fresh oxidation at the clamping point.
- Prevents electrolytic corrosion between aluminum and copper conductors (in the same terminal block).
- Provides long-term protection against corrosion.

Using terminal blocks with CAGE CLAMP® Spring Pressure Connection Technology, **aluminum conductors must first be cleaned with a blade** and then immediately be inserted into the clamping units filled with "Alu-Plus" Contact Paste.

It is also possible to apply WAGO "Alu-Plus" **additionally** on the whole surface of the aluminum conductor before termination.

Please note that the nominal currents must be adapted to the reduced conductivity of the aluminum conductors::

2.5 mm<sup>2</sup> = 16 A

4 mm<sup>2</sup> = 22 A

Solid conductor	0.08 ... 4 mm <sup>2</sup> / 28 ... 12 AWG
Fine-stranded conductor	0.08 ... 4 mm <sup>2</sup> / 28 ... 12 AWG
Strip length	9 ... 10 mm / 0.35 ... 0.39 inches
Wiring direction	Front-entry wiring

### Physical data

Width	8 mm / 0.315 inches
Height	60 mm / 2.362 inches
Depth from upper-edge of DIN-rail	60 mm / 2.362 inches

### Mechanical Data

Design	angled
Mounting type	DIN-35 rail
Marking level	Center marking

Subject to changes. Please also observe the further product documentation!

WAGO GmbH & Co. KG  
 Hansastr. 27  
 32423 Minden  
 Phone: +49571 887-0 | Fax: +49571 887-169  
 Email: [info.de@wago.com](mailto:info.de@wago.com) | Web: [www.wago.com](http://www.wago.com)

Do you have any questions about our products?  
 We are always happy to take your call at +49 (571) 887-44222.

## Material Data

Note (material data)

Information on material specifications can be found here

Color	gray
Material group	I
Insulation material	Polyamide (PA66)
Flammability class per UL94	V0
Fire load	0.324 MJ
Weight	17.7 g

## Environmental requirements

Processing temperature	-35 ... +85 °C
Continuous operating temperature	-60 ... +105 °C

## Commercial data

Product Group	1 (Rail Mounted Terminal Blocks)
eCl@ss 10.0	27-14-11-16
eCl@ss 9.0	27-14-11-16
ETIM 8.0	EC000899
ETIM 7.0	EC000899
PU (SPU)	50 pcs
Packaging type	box
Country of origin	DE
GTIN	4045454197001
Customs tariff number	85369095000

## Environmental Product Compliance

RoHS Compliance Status	Compliant, No Exemption
------------------------	-------------------------

## Approvals / Certificates



### General approvals

Logo	Approval	Additional Approval Text	Certificate name
	CSA DEKRA Certification B.V.	C22.2 No. 158	1505034



Subject to changes. Please also observe the further product documentation!

	KEMA/KEUR DEKRA Certification B.V.	EN 60947	NTR NL- 7135
	KEMA/KEUR DEKRA Certification B.V.	EN 60947	2160584.31
	UR UL International Germany GmbH	UL 1059	E45172

## Declarations of conformity and manufacturer's declarations

Logo	Approval	Additional Approval Text	Certificate name
	EU-Declaration of Conformity WAGO GmbH & Co. KG	-	-
	UK-Declaration of Conformity WAGO GmbH & Co. KG	-	-

## Approvals for marine applications

Logo	Approval	Additional Approval Text	Certificate name
	ABS American Bureau of Shipping	-	20- HG1941090- PDA
	DNV GL Det Norske Veritas, Germanischer Lloyd	-	TAE00001V2

## Required accessories

## End plate

End plate

Subject to changes. Please also observe the further product documentation!



**Item no.: 281-309**  
End and intermediate plate; 2.5 mm thick; orange

[www.wago.com/281-309](http://www.wago.com/281-309)



**Item no.: 281-311**  
End and intermediate plate; 2.5 mm thick; gray

[www.wago.com/281-311](http://www.wago.com/281-311)

## Optional accessories

### Push-in type wire jumper

#### Jumper



**Item no.: 249-123**  
Push-in type wire jumper; 0.75 mm<sup>2</sup>; insulated; 180 mm long; black

[www.wago.com/249-123](http://www.wago.com/249-123)



**Item no.: 249-126**  
Push-in type wire jumper; 0.75 mm<sup>2</sup>; insulated; 110 mm long; black

[www.wago.com/249-126](http://www.wago.com/249-126)

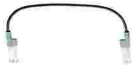

**Item no.: 249-127**  
Push-in type wire jumper; 0.75 mm<sup>2</sup>; insulated; 250 mm long; black

[www.wago.com/249-127](http://www.wago.com/249-127)



**Item no.: 249-125**  
Push-in type wire jumper; insulated; 60 mm long; black

[www.wago.com/249-125](http://www.wago.com/249-125)

### Mounting

#### Cover carrier



**Item no.: 709-167**  
Cover carrier; Type 1; incl. fixing/retaining screws and knurled nut; suitable for 279 to 282 and 880 Series rail-mounted terminal blocks; suitable for 264 Series miniature rail-mounted terminal blocks; suitable for 270 Series sensor and actuator terminal blocks; gray

[www.wago.com/709-167](http://www.wago.com/709-167)

#### Cover



**Item no.: 709-153**  
Cover; Type 1; suitable for cover carrier, type 1; 1 m long; transparent

[www.wago.com/709-153](http://www.wago.com/709-153)

#### Mounting accessories



**Item no.: 209-106**  
Mounting carrier; for isolated mounting on DIN 35 rails; gray

[www.wago.com/209-106](http://www.wago.com/209-106)



**Item no.: 249-116**  
Screwless end stop; 6 mm wide; for DIN-rail 35 x 15 and 35 x 7.5; gray

[www.wago.com/249-116](http://www.wago.com/249-116)

### Locking levers

#### Locking system













**Item no.: 210-254**  
Interlocking link; mechanically locks multiple links; 1 m long; transparent

[www.wago.com/210-254](http://www.wago.com/210-254)

Subject to changes. Please also observe the further product documentation!

## Marking accessories

Marker		
	<b>Item no.: 2009-115/000-002</b> WMB-Inline; for Smart Printer; 1500 pieces on roll; stretchable 5 - 5.2 mm; plain; snap-on type; yellow	<a href="http://www.wago.com/2009-115/000-002">www.wago.com/2009-115/000-002</a>
	<b>Item no.: 2009-115/000-007</b> WMB-Inline; for Smart Printer; 1500 pieces on roll; stretchable 5 - 5.2 mm; plain; snap-on type; gray	<a href="http://www.wago.com/2009-115/000-007">www.wago.com/2009-115/000-007</a>
	<b>Item no.: 2009-115/000-017</b> WMB-Inline; for Smart Printer; 1500 pieces on roll; stretchable 5 - 5.2 mm; plain; snap-on type; light green	<a href="http://www.wago.com/2009-115/000-017">www.wago.com/2009-115/000-017</a>
	<b>Item no.: 2009-115/000-023</b> WMB-Inline; for Smart Printer; 1500 pieces on roll; stretchable 5 - 5.2 mm; plain; snap-on type; green	<a href="http://www.wago.com/2009-115/000-023">www.wago.com/2009-115/000-023</a>
	<b>Item no.: 2009-115/000-024</b> WMB-Inline; for Smart Printer; 1500 pieces on roll; stretchable 5 - 5.2 mm; plain; snap-on type; violet	<a href="http://www.wago.com/2009-115/000-024">www.wago.com/2009-115/000-024</a>
	<b>Item no.: 2009-115</b> WMB-Inline; for Smart Printer; 1500 pieces on roll; stretchable 5 - 5.2 mm; plain; snap-on type; white	<a href="http://www.wago.com/2009-115">www.wago.com/2009-115</a>
	<b>Item no.: 793-5501/000-007</b> WMB marking card; as card; for terminal block width 5 - 17.5 mm; stretchable 5 - 5.2 mm; plain; snap-on type; gray	<a href="http://www.wago.com/793-5501/000-007">www.wago.com/793-5501/000-007</a>
	<b>Item no.: 793-5501/000-012</b> WMB marking card; as card; for terminal block width 5 - 17.5 mm; stretchable 5 - 5.2 mm; plain; snap-on type; orange	<a href="http://www.wago.com/793-5501/000-012">www.wago.com/793-5501/000-012</a>
	<b>Item no.: 793-5501/000-017</b> WMB marking card; as card; for terminal block width 5 - 17.5 mm; stretchable 5 - 5.2 mm; plain; snap-on type; light green	<a href="http://www.wago.com/793-5501/000-017">www.wago.com/793-5501/000-017</a>
	<b>Item no.: 793-5501/000-023</b> WMB marking card; as card; for terminal block width 5 - 17.5 mm; stretchable 5 - 5.2 mm; plain; snap-on type; green	<a href="http://www.wago.com/793-5501/000-023">www.wago.com/793-5501/000-023</a>
	<b>Item no.: 793-5501/000-024</b> WMB marking card; as card; for terminal block width 5 - 17.5 mm; stretchable 5 - 5.2 mm; plain; snap-on type; violet	<a href="http://www.wago.com/793-5501/000-024">www.wago.com/793-5501/000-024</a>

Subject to changes. Please also observe the further product documentation!



**Item no.:** 793-501/000-002

WMB marking card; as card; not stretchable; plain; snap-on type; yellow

[www.wago.com/793-501/000-002](http://www.wago.com/793-501/000-002)



**Item no.:** 793-501/000-007

WMB marking card; as card; not stretchable; plain; snap-on type; gray

[www.wago.com/793-501/000-007](http://www.wago.com/793-501/000-007)



**Item no.:** 793-501/000-017

WMB marking card; as card; not stretchable; plain; snap-on type; light green

[www.wago.com/793-501/000-017](http://www.wago.com/793-501/000-017)



**Item no.:** 793-501/000-012

WMB marking card; as card; not stretchable; plain; snap-on type; orange

[www.wago.com/793-501/000-012](http://www.wago.com/793-501/000-012)



**Item no.:** 793-501/000-023

WMB marking card; as card; not stretchable; plain; snap-on type; green

[www.wago.com/793-501/000-023](http://www.wago.com/793-501/000-023)



**Item no.:** 793-501/000-006

WMB marking card; as card; not stretchable; plain; snap-on type; blue

[www.wago.com/793-501/000-006](http://www.wago.com/793-501/000-006)



**Item no.:** 793-501/000-005

WMB marking card; as card; not stretchable; plain; snap-on type; red

[www.wago.com/793-501/000-005](http://www.wago.com/793-501/000-005)



**Item no.:** 793-501

WMB marking card; as card; not stretchable; plain; snap-on type; white

[www.wago.com/793-501](http://www.wago.com/793-501)

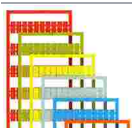

**Item no.:** 793-501/000-024

WMB marking card; as card; not stretchable; plain; snap-on type; violet

[www.wago.com/793-501/000-024](http://www.wago.com/793-501/000-024)

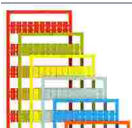

**Item no.:** 793-5501/000-005

WMB marking card; as card; for terminal block width 5 - 17.5 mm; stretchable 5 - 5.2 mm; plain; snap-on type; red

[www.wago.com/793-5501/000-005](http://www.wago.com/793-5501/000-005)

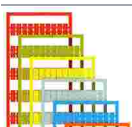

**Item no.:** 793-5501/000-002

WMB marking card; as card; for terminal block width 5 - 17.5 mm; stretchable 5 - 5.2 mm; plain; snap-on type; yellow

[www.wago.com/793-5501/000-002](http://www.wago.com/793-5501/000-002)

Subject to changes. Please also observe the further product documentation!

WAGO GmbH & Co. KG

Hansastr. 27

32423 Minden

Phone: +49571 887-0 | Fax: +49571 887-169

Email: [info.de@wago.com](mailto:info.de@wago.com) | Web: [www.wago.com](http://www.wago.com)

Do you have any questions about our products?

We are always happy to take your call at +49 (571) 887-44222.





**Item no.: 793-5501/000-006**

WMB marking card; as card; for terminal block width 5 - 17.5 mm; stretchable 5 - 5.2 mm; plain; snap-on type; blue [www.wago.com/793-5501/000-006](http://www.wago.com/793-5501/000-006)



**Item no.: 793-5501**

WMB marking card; as card; for terminal block width 5 - 17.5 mm; stretchable 5 - 5.2 mm; plain; snap-on type; white [www.wago.com/793-5501](http://www.wago.com/793-5501)



**Item no.: 2009-115/000-012**

WMB-Inline; for Smart Printer; 1500 pieces on roll; stretchable 5 - 5.2 mm; plain; snap-on type; orange [www.wago.com/2009-115/000-012](http://www.wago.com/2009-115/000-012)



**Item no.: 2009-115/000-006**

WMB-Inline; for Smart Printer; 1500 pieces on roll; stretchable 5 - 5.2 mm; plain; snap-on type; blue [www.wago.com/2009-115/000-006](http://www.wago.com/2009-115/000-006)

**Carrier rail**

Mounting accessories



**Item no.: 210-197**

Steel carrier rail; 35 x 15 mm; 1.5 mm thick; 2 m long; slotted; similar to EN 60715; silver-colored [www.wago.com/210-197](http://www.wago.com/210-197)



**Item no.: 210-198**

Copper carrier rail; 35 x 15 mm; 2.3 mm thick; 2 m long; unslotted; according to EN 60715; copper-colored [www.wago.com/210-198](http://www.wago.com/210-198)



**Item no.: 210-504**

Steel carrier rail; 35 x 7.5 mm; 1 mm thick; 2 m long; slotted; galvanized; according to EN 60715; silver-colored [www.wago.com/210-504](http://www.wago.com/210-504)



**Item no.: 210-505**

Steel carrier rail; 35 x 7.5 mm; 1 mm thick; 2 m long; unslotted; galvanized; according to EN 60715; silver-colored [www.wago.com/210-505](http://www.wago.com/210-505)



**Item no.: 210-506**

Steel carrier rail; 35 x 15 mm; 1.5 mm thick; 2 m long; unslotted; galvanized; similar to EN 60715; silver-colored [www.wago.com/210-506](http://www.wago.com/210-506)



**Item no.: 210-508**

Steel carrier rail; 35 x 15 mm; 1.5 mm thick; 2 m long; slotted; galvanized; similar to EN 60715; silver-colored [www.wago.com/210-508](http://www.wago.com/210-508)



**Item no.: 210-113**

Steel carrier rail; 35 x 7.5 mm; 1 mm thick; 2 m long; unslotted; according to EN 60715; silver-colored [www.wago.com/210-113](http://www.wago.com/210-113)

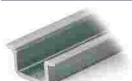

**Item no.: 210-118**

Steel carrier rail; 35 x 15 mm; 2.3 mm thick; 2 m long; unslotted; according to EN 60715; silver-colored [www.wago.com/210-118](http://www.wago.com/210-118)



**Item no.: 210-112**

Steel carrier rail; 35 x 7.5 mm; 1 mm thick; 2 m long; slotted; according to EN 60715; "Hole width 25 mm; silver-colored [www.wago.com/210-112](http://www.wago.com/210-112)



**Item no.: 210-114**

Steel carrier rail; 35 x 15 mm; 1.5 mm thick; 2 m long; unslotted; similar to EN 60715; silver-colored [www.wago.com/210-114](http://www.wago.com/210-114)

Subject to changes. Please also observe the further product documentation!



**Item no.: 210-115**

Steel carrier rail; 35 x 7.5 mm; 1 mm thick; 2 m long; slotted; according to EN 60715; "Hole width 18 mm; [www.wago.com/210-115](http://www.wago.com/210-115)  
silver-colored



**Item no.: 210-196**

Aluminum carrier rail; 35 x 8.2 mm; 1.6 mm thick; 2 m long; unslotted; similar to EN 60715; silver-colored [www.wago.com/210-196](http://www.wago.com/210-196)

**Ferrule**

Ferrule



**Item no.: 216-106**

Ferrule; Sleeve for 2.5 mm<sup>2</sup> / AWG 14; uninsulated; electro-tin plated; silver-colored [www.wago.com/216-106](http://www.wago.com/216-106)



**Item no.: 216-203**

Ferrule; Sleeve for 1 mm<sup>2</sup> / AWG 18; insulated; electro-tin plated; red [www.wago.com/216-203](http://www.wago.com/216-203)



**Item no.: 216-206**

Ferrule; Sleeve for 2.5 mm<sup>2</sup> / AWG 14; insulated; electro-tin plated; blue [www.wago.com/216-206](http://www.wago.com/216-206)



**Item no.: 216-202**

Ferrule; Sleeve for 0.75 mm<sup>2</sup> / 18 AWG; insulated; electro-tin plated; gray [www.wago.com/216-202](http://www.wago.com/216-202)



**Item no.: 216-204**

Ferrule; Sleeve for 1.5 mm<sup>2</sup> / AWG 16; insulated; electro-tin plated; black [www.wago.com/216-204](http://www.wago.com/216-204)



**Item no.: 216-205**

Ferrule; Sleeve for 2.08 mm<sup>2</sup> / AWG 14; insulated; electro-tin plated; yellow [www.wago.com/216-205](http://www.wago.com/216-205)



**Item no.: 216-201**

Ferrule; Sleeve for 0.5 mm<sup>2</sup> / 20 AWG; insulated; electro-tin plated; white [www.wago.com/216-201](http://www.wago.com/216-201)



**Item no.: 216-241**

Ferrule; Sleeve for 0.5 mm<sup>2</sup> / 20 AWG; insulated; electro-tin plated; electrolytic copper; gastight crimped; acc. to DIN 46228, Part 4/09.90; white [www.wago.com/216-241](http://www.wago.com/216-241)



**Item no.: 216-242**

Ferrule; Sleeve for 0.75 mm<sup>2</sup> / 18 AWG; insulated; electro-tin plated; electrolytic copper; gastight crimped; acc. to DIN 46228, Part 4/09.90; gray [www.wago.com/216-242](http://www.wago.com/216-242)



**Item no.: 216-243**

Ferrule; Sleeve for 1 mm<sup>2</sup> / AWG 18; insulated; electro-tin plated; electrolytic copper; gastight crimped; acc. to DIN 46228, Part 4/09.90; red [www.wago.com/216-243](http://www.wago.com/216-243)



**Item no.: 216-244**

Ferrule; Sleeve for 1.5 mm<sup>2</sup> / AWG 16; insulated; electro-tin plated; electrolytic copper; gastight crimped; acc. to DIN 46228, Part 4/09.90; black [www.wago.com/216-244](http://www.wago.com/216-244)



**Item no.: 216-246**

Ferrule; Sleeve for 2.5 mm<sup>2</sup> / AWG 14; insulated; electro-tin plated; electrolytic copper; gastight crimped; acc. to DIN 46228, Part 4/09.90; blue [www.wago.com/216-246](http://www.wago.com/216-246)



**Item no.: 216-301**

Ferrule; Sleeve for 0.25 mm<sup>2</sup> / AWG 24; insulated; electro-tin plated; yellow [www.wago.com/216-301](http://www.wago.com/216-301)



**Item no.: 216-302**

Ferrule; Sleeve for 0.34 mm<sup>2</sup> / 22 AWG; insulated; electro-tin plated; light turquoise [www.wago.com/216-302](http://www.wago.com/216-302)

**Tool**

Subject to changes. Please also observe the further product documentation!

---

 Operating tool
 

---

**Item no.: 210-657**

Operating tool; Blade: 3.5 x 0.5 mm; with a partially insulated shaft; short; multicoloured

[www.wago.com/210-657](http://www.wago.com/210-657)**Item no.: 210-658**

Operating tool; Blade: 3.5 x 0.5 mm; with a partially insulated shaft; angled; short; multicoloured

[www.wago.com/210-658](http://www.wago.com/210-658)**Item no.: 210-720**

Operating tool; Blade: 3.5 x 0.5 mm; with a partially insulated shaft; multicoloured

[www.wago.com/210-720](http://www.wago.com/210-720)

---

 Testing and measuring
 

---

## Testing accessories

**Item no.: 281-407**Test plug; 6 mm wide; Nominal current 24 A; for 0.08 mm<sup>2</sup> - 2.5 mm<sup>2</sup>; 2,50 mm<sup>2</sup>; gray[www.wago.com/281-407](http://www.wago.com/281-407)**Item no.: 280-404**Test plug adapter; 5 mm wide; for test plug (2.3 mm Ø); suitable for 1.5 mm<sup>2</sup> - 4 mm<sup>2</sup> tbs; gray[www.wago.com/280-404](http://www.wago.com/280-404)

---

 Jumpers
 

---

## Jumper

**Item no.: 210-123**

Wire commoning chain; insulated; blue

[www.wago.com/210-123](http://www.wago.com/210-123)**Item no.: 210-103**

Wire commoning chain; insulated; black

[www.wago.com/210-103](http://www.wago.com/210-103)**Item no.: 281-402**

Jumper; insulated; gray

[www.wago.com/281-402](http://www.wago.com/281-402)**Item no.: 709-110**Wire commoning chain; 2.5 mm<sup>2</sup>; insulated; black[www.wago.com/709-110](http://www.wago.com/709-110)**Item no.: 709-112**Wire commoning chain; 2.5 mm<sup>2</sup>; insulated; black[www.wago.com/709-112](http://www.wago.com/709-112)**Item no.: 709-111**Wire commoning chain; 2.5 mm<sup>2</sup>; insulated; black[www.wago.com/709-111](http://www.wago.com/709-111)

---

 Downloads
 

---

## Documentation

## Bid Text

281-612/281-417

2019 Feb 19

xml  
3.7 kB

Download

Subject to changes. Please also observe the further product documentation!

WAGO GmbH &amp; Co. KG

Hansastr. 27

32423 Minden

Phone: +49571 887-0 | Fax: +49571 887-169

Email: [info.de@wago.com](mailto:info.de@wago.com) | Web: [www.wago.com](http://www.wago.com)

Do you have any questions about our products?

We are always happy to take your call at +49 (571) 887-44222.



X81 - Datei

281-612/281-417 doc - Datei	2017 Mar 14	doc 26.6 kB	Download
--------------------------------	-------------	----------------	----------

Additional Information

Technical Section Technical explanations		pdf 2.2 MB	Download
---	--	---------------	----------

CAD/CAE-Data

CAD data

2D/3D Models 281-612/281-417		URL	Download
------------------------------	--	-----	----------

CAE data

EPLAN Data Portal 281-612/281-417		URL	Download
-----------------------------------	--	-----	----------

WSCAD Universe 281-612/281-417		URL	Download
--------------------------------	--	-----	----------

ZUKEN Portal 281-612/281-417		URL	Download
------------------------------	--	-----	----------

WSCAD Universe 281-612/281-417		URL	Download
--------------------------------	--	-----	----------

EPLAN Data Portal 281-612/281-417		URL	Download
-----------------------------------	--	-----	----------

Environmental Product Compliance

Compliance Search

Environmental Product Compliance 281-612/281-417 2-conductor fuse terminal block; with pivoting fuse holder; with blown fuse indication by neon lamp; 230 V; for DIN-rail 35 x 15 and 35 x 7.5; 4 mm <sup>2</sup> ; CAGE CLAMP®; 4,00 mm <sup>2</sup> ; gray		URL	Download
---	--	-----	----------

Installation Notes

Conductor termination

Subject to changes. Please also observe the further product documentation!



#### CAGE CLAMP® connection

Inserting a conductor.

With ferruled conductors, it is necessary to use a terminal block one size smaller than the conductor's nominal cross-section.

#### Commoning

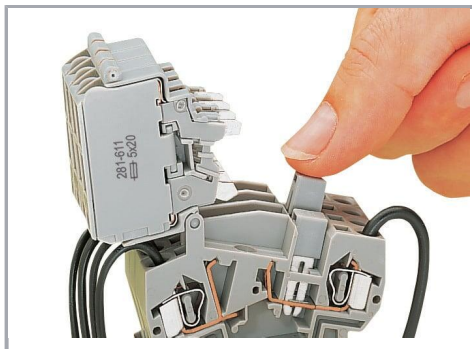

#### Commoning

Distributing current to several fuse-protected circuits via insulated push-in type jumpers.

#### Testing

Subject to changes. Please also observe the further product documentation!

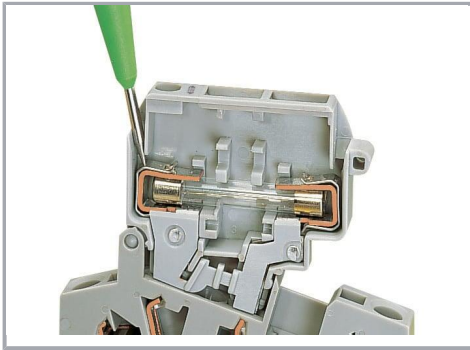

Voltage test, either at input or output with fuse holder in closed position (live)

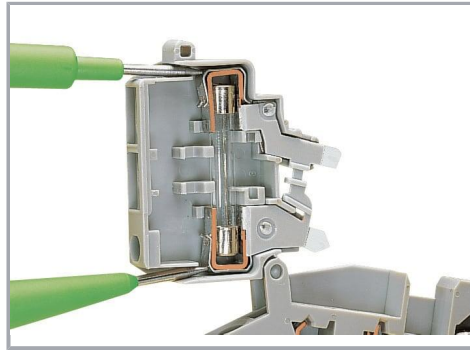

Through test with fuse holder in open position (no voltage)

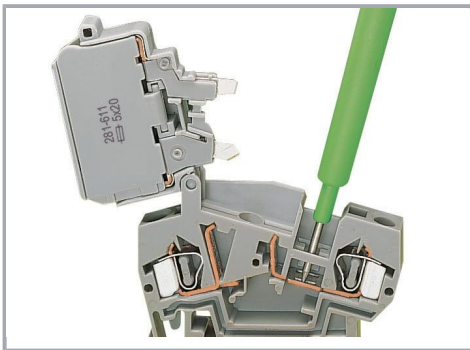

Voltage test at input in the test slot of the current bar

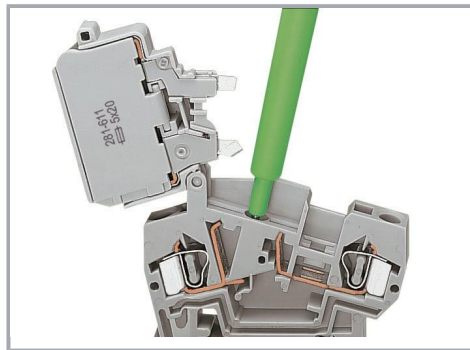

Testing voltage at the output via separate test slot.

Subject to changes. Please also observe the further product documentation!

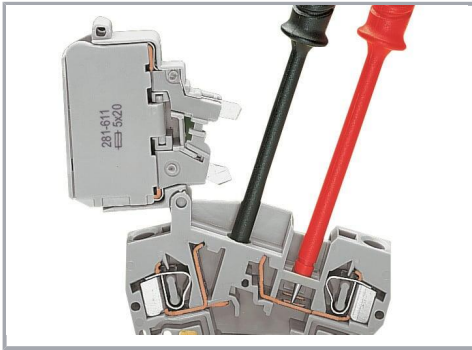

Measuring current between jumper slot and separate test slot.

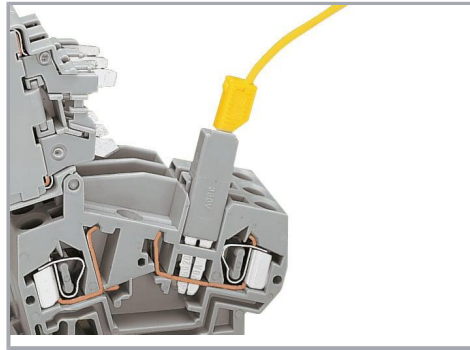

Testing voltage (input side) via test plug adapter (280-404, shown) or test plug (281-407).

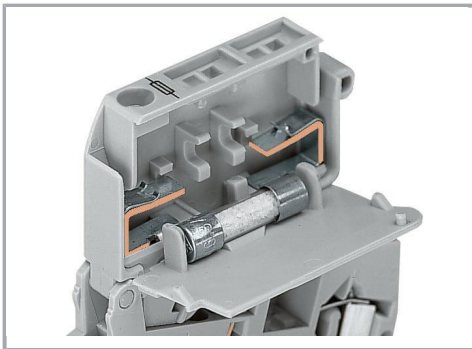

5 x 20 mm, 5 x 25 mm and 1/4" x 1" fuse holders are fitted with stops on the inside of the cover.

### Security

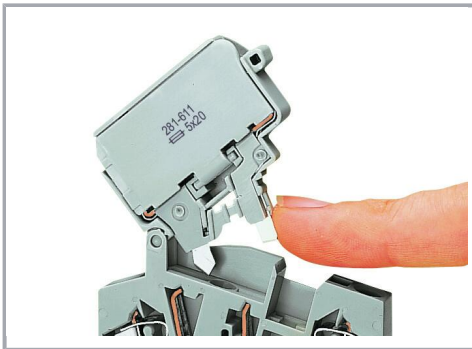

Touch-proof protection in all positions of the fuse holder



Fuse holder will remain safely locked open in vertical assemblies.

### Locking system

Subject to changes. Please also observe the further product documentation!



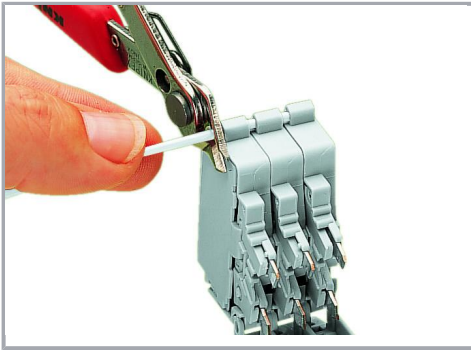

Ganging several fuse holders with an interlocking link (example shows 8 mm wide terminal blocks).



**Fuse replacement:**

Before replacing a fuse, pivot the fuse holder into the locked open position.

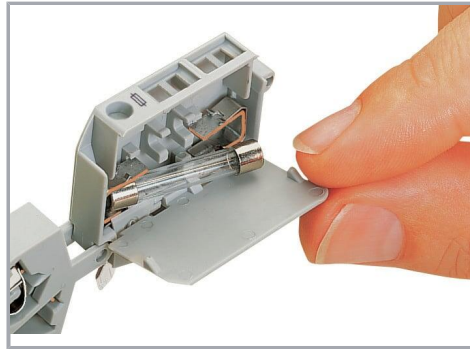

**Fuse replacement:**

One end of the fuse is automatically ejected from the holder when opening the cover.

Subject to changes. Please also observe the further product documentation!



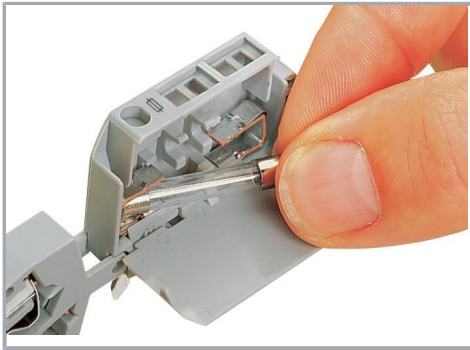

**Fuse replacement:**

Easily removing a fuse by hand.



**Fuse replacement:**

Insert a new fuse and snap the cover closed.

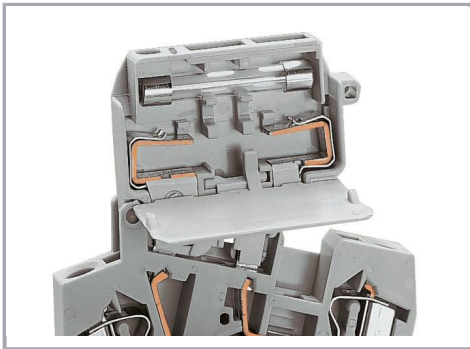

Storing a spare fuse (fuse holder without blown fuse indication).

Subject to changes. Please also observe the further product documentation!

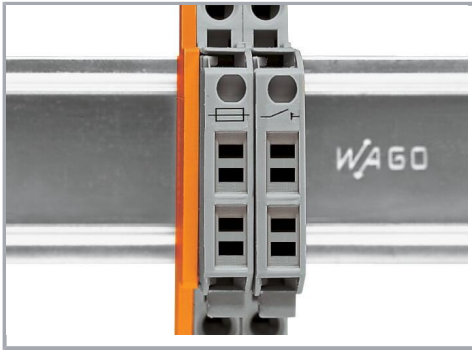

Fused disconnect or disconnect terminal blocks with a width of 8 mm can be assembled adjacently. At the end of an assembly, or if there is **no** adjacent fused disconnect or disconnect terminal block, an end or intermediate plate must be used.

#### Marking



All fuse holders are printed with correct fuse size.

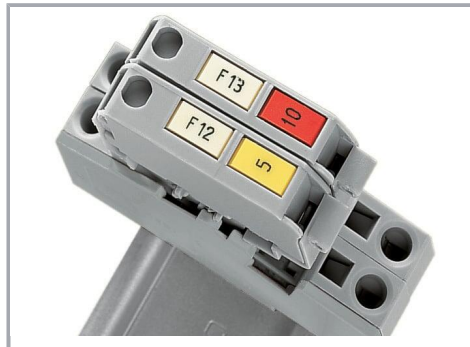

Each fuse holder features two marker slots for custom WMB Multi markers (example shows 8 mm wide terminal blocks).

Subject to changes. Please also observe the further product documentation!