

**PKB 5000W series** Direct Converters  
 Input 18 - 75 V, Output up to 30 A / 120 W

28701- BMR 709 Rev. C November 2017

© Flex

### Key Features

- Industry standard through-hole Eighth-brick  
 58.4 x 22.9 x 9.91 mm (2.3 x 0.9 x 0.39 in)
- Wide input range of 18-75Vdc
- Up to 120 Watts
- High efficiency, typ. 91.5% at 12 Vout full load
- 2250 Vdc input to output isolation
- Meets basic insulation and safety requirements according to IEC/EN/UL 60950-1
- MTBF 17 Mh

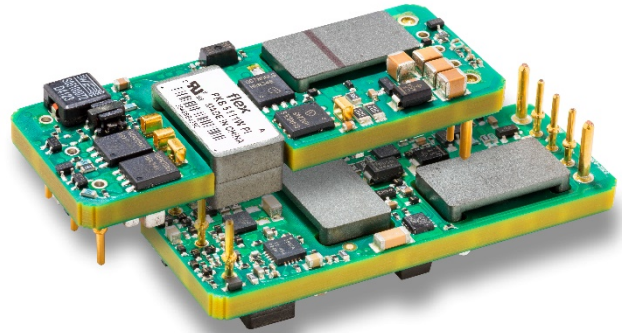

### General Characteristics

- Output over voltage protection
- Input under voltage shutdown
- Over temperature protection
- Output short-circuit protection
- Outstanding thermal performance and derating
- Remote sense
- Remote control
- Highly automated manufacturing ensures quality
- ISO 9001/14001 certified supplier

### Safety Approvals



### Design for Environment



Meets requirements in high-temperature lead-free soldering processes.

### Contents

Ordering Information	2
General Information	2
Safety Specification	3
Absolute Maximum Ratings	4
Electrical Specification	
3.3V, 30A / 99W	PKB 5110W PI..... 5
5V, 20A / 100W	PKB 5111W PI..... 9
12V, 10A / 120W	PKB 5113W PI..... 13
EMC Specification	17
Operating Information	18
Thermal Consideration	20
Connections	21
Mechanical Information	22
Soldering Information	24
Delivery Information	24
Product Qualification Specification	25

**PKB 5000W series** Direct Converters  
Input 18 - 75 V, Output up to 30 A / 120 W

28701- BMR 709 Rev. C November 2017

© Flex

### Ordering Information

Product program	Output
PKB 5110W	3.3 V, 30 A / 99 W
PKB 5111W	5 V, 20 A / 100 W
PKB 5113W	12 V, 10 A / 100 W

### Product number and Packaging

PKB 5XXXW n <sub>1</sub> n <sub>2</sub> n <sub>3</sub> n <sub>4</sub>				
Options	n <sub>1</sub>	n <sub>2</sub>	n <sub>3</sub>	n <sub>4</sub>
Mounting	o			
Mechanical option		o		
Remote Control logic			o	
Lead length				o

Options	Description
n <sub>1</sub>	PI Through hole*
n <sub>2</sub>	open frame* HS baseplate
n <sub>3</sub>	negative logic*
n <sub>4</sub>	4.8mm*

Example a through-hole mounted, negative logic product with baseplate would be PKB 5110W PIHS.

\* Standard variant (i.e. no option selected).

### General Information

#### Reliability

The failure rate ( $\lambda$ ) and mean time between failures (MTBF =  $1/\lambda$ ) is calculated at max output power and an operating ambient temperature ( $T_A$ ) of +25°C. Flex uses Telcordia SR-332 Issue 3 Method 1 to calculate the mean steady-state failure rate and standard deviation ( $\sigma$ ).

Telcordia SR-332 Issue 3 also provides techniques to estimate the upper confidence levels of failure rates based on the mean and standard deviation.

Mean steady-state failure rate, $\lambda$	Std. deviation, $\sigma$
58.6 nFailures/h	8.7 nFailures/h

MTBF (mean value) for the PKB-W series = 17 Mh.

MTBF at 90% confidence level = 14 Mh

#### Compatibility with RoHS requirements

The products are compatible with the relevant clauses and requirements of the RoHS directive 2011/65/EU and have a maximum concentration value of 0.1% by weight in homogeneous materials for lead, mercury, hexavalent chromium, PBB and PBDE and of 0.01% by weight in homogeneous materials for cadmium.

Exemptions in the RoHS directive utilized in Flex products are found in the Statement of Compliance document.

Flex fulfills and will continuously fulfill all its obligations under regulation (EC) No 1907/2006 concerning the registration, evaluation, authorization and restriction of chemicals (REACH) as they enter into force and is through product materials declarations preparing for the obligations to communicate information on substances in the products.

#### Quality Statement

The products are designed and manufactured in an industrial environment where quality systems and methods like ISO 9000, Six Sigma, and SPC are intensively in use to boost the continuous improvements strategy. Infant mortality or early failures in the products are screened out and they are subjected to an ATE-based final test. Conservative design rules, design reviews and product qualifications, plus the high competence of an engaged work force, contribute to the high quality of the products.

#### Warranty

Warranty period and conditions are defined in Flex General Terms and Conditions of Sale.

#### Limitation of Liability

Flex does not make any other warranties, expressed or implied including any warranty of merchantability or fitness for a particular purpose (including, but not limited to, use in life support applications, where malfunctions of product can cause injury to a person's health or life).

#### © Flex 2017

The information and specifications in this technical specification is believed to be correct at the time of publication. However, no liability is accepted for inaccuracies, printing errors or for any consequences thereof. Flex reserves the right to change the contents of this technical specification at any time without prior notice.

<b>PKB 5000W series Direct Converters</b> Input 18 - 75 V, Output up to 30 A / 120 W	28701- BMR 709 Rev. C November 2017
	© Flex

## Safety Specification

### General information

Flex DC/DC converters and DC/DC regulators are designed in accordance with the safety standards IEC 60950-1, EN 60950-1 and UL 60950-1 *Safety of Information Technology Equipment*.

IEC/EN/UL 60950-1 contains requirements to prevent injury or damage due to the following hazards:

- Electrical shock
- Energy hazards
- Fire
- Mechanical and heat hazards
- Radiation hazards
- Chemical hazards

On-board DC/DC converters and DC/DC regulators are defined as component power supplies. As components they cannot fully comply with the provisions of any safety requirements without "conditions of acceptability". Clearance between conductors and between conductive parts of the component power supply and conductors on the board in the final product must meet the applicable safety requirements. Certain conditions of acceptability apply for component power supplies with limited stand-off (see Mechanical Information and Safety Certificate for further information). It is the responsibility of the installer to ensure that the final product housing these components complies with the requirements of all applicable safety standards and regulations for the final product.

Component power supplies for general use should comply with the requirements in IEC/EN/UL 60950-1 *Safety of Information Technology Equipment*. Product related standards, e.g. IEEE 802.3af *Power over Ethernet*, and ETS-300132-2 *Power interface at the input to telecom equipment, operated by direct current (dc)* are based on IEC/EN/UL 60950-1 with regards to safety.

Flex DC/DC converters, Power interface modules and DC/DC regulators are UL 60950-1 recognized and certified in accordance with EN 60950-1. The flammability rating for all construction parts of the products meet requirements for V-0 class material according to IEC 60695-11-10, *Fire hazard testing, test flames – 50 W horizontal and vertical flame test methods*.

### Isolated DC/DC converters & Power interface modules

The product may provide basic or functional insulation between input and output according to IEC/EN/UL 60950-1 (see Safety Certificate), different conditions shall be met if the output of a basic or a functional insulated product shall be considered as safety extra low voltage (SELV).

For basic insulated products (see Safety Certificate) the output is considered as safety extra low voltage (SELV) if one of the following conditions is met:

- The input source provides supplementary or double or reinforced insulation from the AC mains according to IEC/EN/UL 60950-1.
- The input source provides functional or basic insulation from the AC mains and the product's output is reliably connected to protective earth according to IEC/EN/UL 60950-1.

For functional insulated products (see Safety Certificate) the output is considered as safety extra low voltage (SELV) if one of the following conditions is met:

- The input source provides double or reinforced insulation from the AC mains according to IEC/EN/UL 60950-1.
- The input source provides basic or supplementary insulation from the AC mains and the product's output is reliably connected to protective earth according to IEC/EN/UL 60950-1.
- The input source is reliably connected to protective earth and provides basic or supplementary insulation according to IEC/EN/UL 60950-1 and the maximum input source voltage is 60 Vdc.

Galvanic isolation between input and output is verified in an electric strength test and the isolation voltage ( $V_{iso}$ ) meets the voltage strength requirement for basic insulation according to IEC/EN/UL 60950-1.

It is recommended to use a slow blow fuse at the input of each DC/DC converter. If an input filter is used in the circuit the fuse should be placed in front of the input filter. In the rare event of a component problem that imposes a short circuit on the input source, this fuse will provide the following functions:

- Isolate the fault from the input power source so as not to affect the operation of other parts of the system
- Protect the distribution wiring from excessive current and power loss thus preventing hazardous overheating

**PKB 5000W series** Direct Converters  
 Input 18 - 75 V, Output up to 30 A / 120 W

28701- BMR 709 Rev. C November 2017

© Flex

### Absolute Maximum Ratings

Characteristics		min	typ	max	Unit
$T_{P1}$	Operating Temperature (see Thermal Consideration section)	-40		+110	°C
$T_S$	Storage temperature	-55		+125	°C
$V_I$	Input voltage	-0.5		+80	V
$V_{iso}$	Isolation voltage (input to output test voltage)			2250	Vdc
$V_{tr}$	Input voltage transient (100msec max. duration, operating or non-operating)			100	V
$V_{RC}$	Remote Control pin voltage (see Operating Information section)	Positive logic option		15	V
		Negative logic option	-0.5	15	V

Stress in excess of Absolute Maximum Ratings may cause permanent damage. Absolute Maximum Ratings, sometimes referred to as no destruction limits, are normally tested with one parameter at a time exceeding the limits in the Electrical Specification. If exposed to stress above these limits, function and performance may degrade in an unspecified manner.

### Fundamental Circuit Diagram

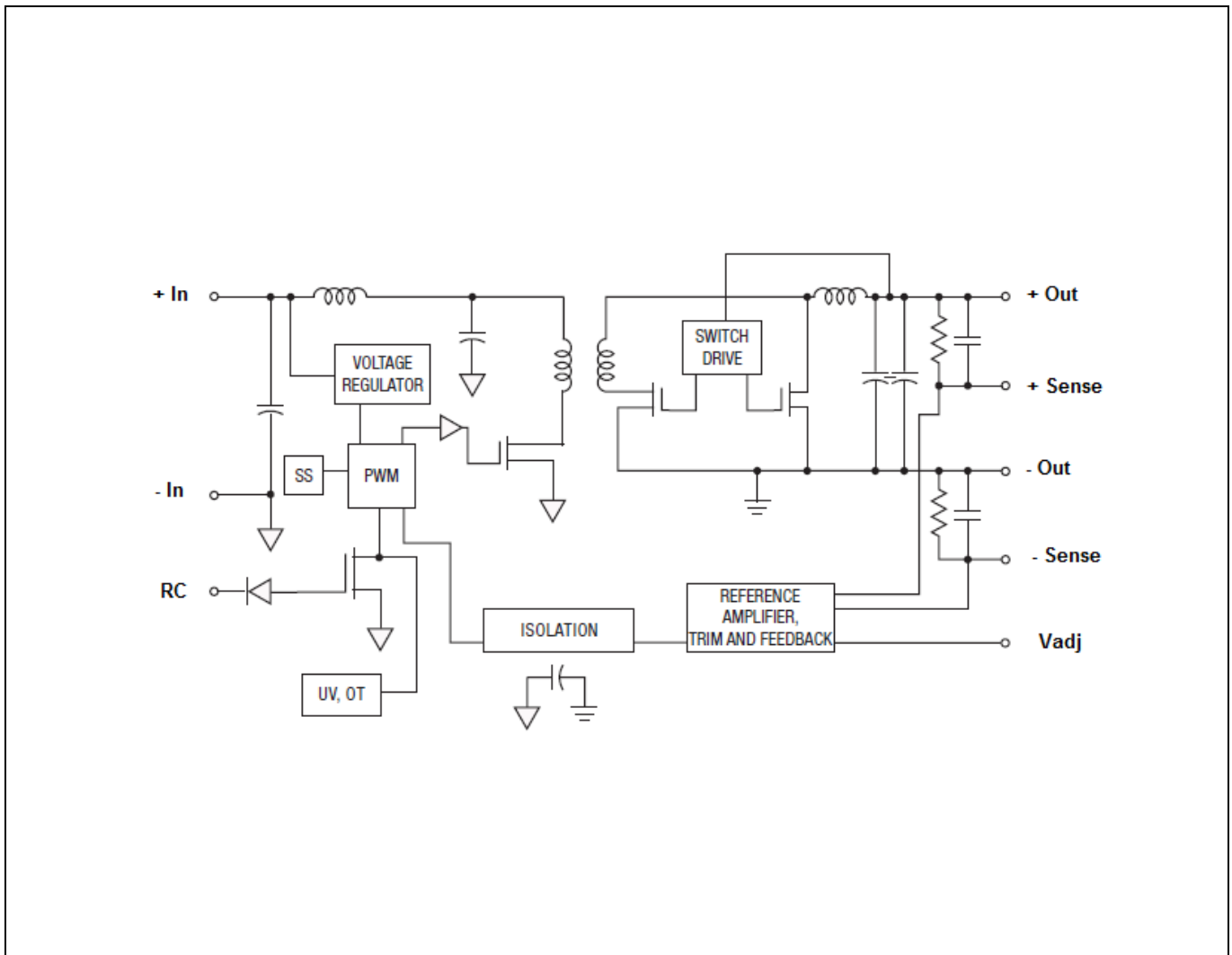

**PKB 5000W series Direct Converters**  
Input 18 - 75 V, Output up to 30 A / 120 W

28701- BMR 709 Rev. C November 2017

© Flex

**Electrical Specification**  
**3.3 V, 30 A / 99 W**

**PKB 5110W PI**

$T_{P1} = -40$  to  $+85^{\circ}\text{C}$ ,  $V_I = 18$  to  $75$  V, sense pins connected to output pins unless otherwise specified under Conditions.  
Typical values given at:  $T_{P1} = +25^{\circ}\text{C}$ ,  $V_I = 48$  V,  $I_O$ , unless otherwise specified under Conditions.  
Additional  $C_{in} = 33 \mu\text{F}$ ,  $C_{out} = 1 \mu\text{F} + 10 \mu\text{F}$ . See Operating Information section for selection of capacitor types.

Characteristics		Conditions	min	typ	max	Unit
$V_I$	Input voltage range		18		75	V
$V_{loff}$	Turn-off input voltage	Decreasing input voltage	16.5	17	17.9	V
$V_{lon}$	Turn-on input voltage	Increasing input voltage	15.5	16.5	17.5	V
$P_O$	Output power		0		99.99	W
$\eta$	Efficiency	max $I_O$		89.5		%
		max $I_O$ , $V_I = 24$ V		90		
$P_d$	Power Dissipation	max $I_O$ , see Note 1		TBD		W
$I_{li}$	Input idling current	$I_O = 0$ A, $V_I = 48$ V		90		mA
$I_{RC}$	Input standby current	$V_I = 48$ V (turned off with RC)		4		mA
$f_s$	Switching frequency	0-100 % of max $I_O$ , see Note 2	195	215	235	kHz

$V_{oi}$	Output voltage initial setting and accuracy	$T_{P1} = +25^{\circ}\text{C}$ , $V_I = 48$ V, $I_O = 15$ A	3.267	3.3	3.333	V
$V_O$	Output adjust range	See operating information	2.97		3.63	V
	Output voltage tolerance band	0-100% of max $I_O$	3.267		3.333	V
	Line regulation	max $I_O$		$\pm 6.6$		mV
	Load regulation	$V_I = 48$ V, 0-100% of max $I_O$		$\pm 6.6$		mV
$V_{tr}$	Load transient voltage deviation	$V_I = 48$ V, Load step 50-75-50% of max $I_O$ , $di/dt = 10$ A/ $\mu\text{s}$		$\pm 500$		mV
$t_{tr}$	Load transient recovery time	see Note 3		50	200	$\mu\text{s}$
$t_s$	Start-up time (from $V_I$ connection to 90% of $V_{oi}$ )	0-100% of max $I_O$		20	30	ms
$t_{RC}$	RC start-up time	max $I_O$		10		ms
$I_O$	Output current		0		30	A
$I_{lim}$	Current limit threshold	$T_{P1} < \text{max } T_{P1}$	33	35	44	A
$I_{sc}$	Short circuit current	$T_{P1} = 25^{\circ}\text{C}$ , see Note 4		5	10	A
$C_{out}$	Recommended Capacitive Load	$T_{P1} = 25^{\circ}\text{C}$ , see Note 5	0		10000	$\mu\text{F}$
$V_{Oac}$	Output ripple & noise	See ripple & noise section, $V_{oi}$		90	125	mVp-p
OVP	Over voltage protection	$T_{P1} = +25^{\circ}\text{C}$ , $V_I = 48$ V, 0-100% of max $I_O$		3.8	4.5	V

Note 1: See power dissipation graph

Note 2: See Operating Information section

Note 3:  $C_{out} = 1 \mu\text{F} + 10 \mu\text{F} + 10000 \mu\text{F}$

Note 4: RMS current, See Operating Information section.

Note 5: See Operating Information section.

**PKB 5000W series** Direct Converters  
 Input 18 - 75 V, Output up to 30 A / 120 W

28701- BMR 709 Rev. C November 2017

© Flex

**Typical Characteristics**  
**3.3 V, 30 A / 99 W**

**PKB 5110W PI**

**Efficiency**

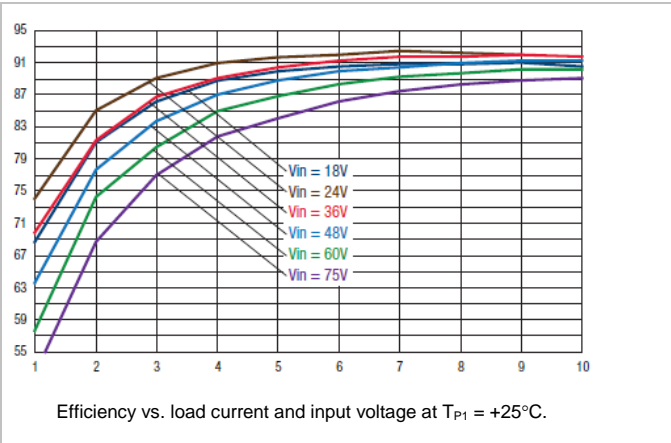

**Power Dissipation**

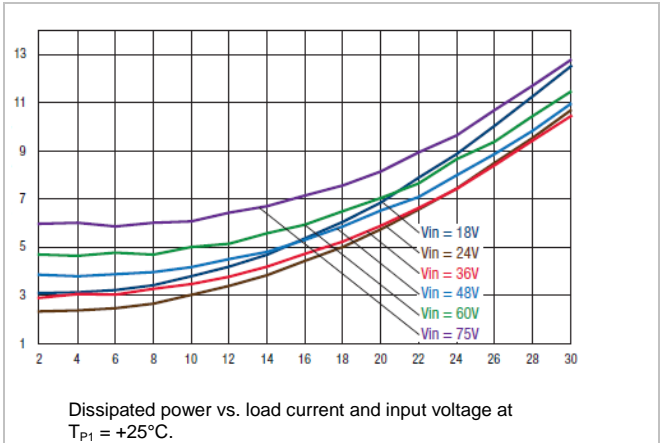

**PKB 5000W series** Direct Converters  
 Input 18 - 75 V, Output up to 30 A / 120 W

28701- BMR 709 Rev. C November 2017

© Flex

### Typical Characteristics 3.3 V, 30 A / 99 W

### PKB 5110W PI

#### Start-up

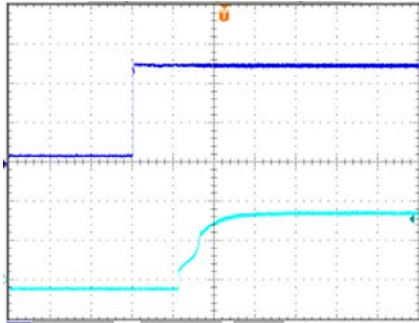

Start-up enabled by connecting  $V_I$  at:  
 $T_{P1} = +25^\circ\text{C}$ ,  $V_I = 48\text{ V}$ ,  
 $I_O = 30\text{ A}$  resistive load.

Top trace: input voltage (20 V/div.).  
 Bottom trace: output voltage (2 V/div.).  
 Time scale: (10 ms/div.).

#### Start-up

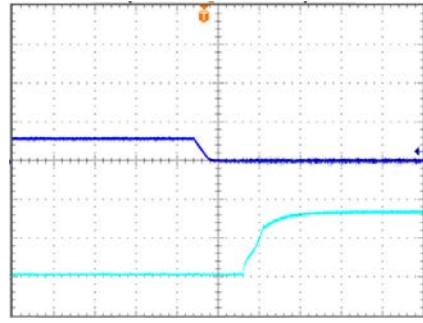

Start-up enabled by grounding RC at:  
 $T_{P1} = +25^\circ\text{C}$ ,  $V_I = 48\text{ V}$ ,  
 $I_O = 30\text{ A}$  resistive load.

Top trace: remote control (5 V/div.).  
 Bottom trace: output voltage (2 V/div.).  
 Time scale: (10 ms/div.).

#### Output Ripple & Noise

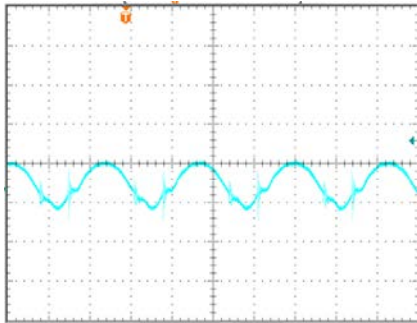

Output voltage ripple at:  
 $T_{P1} = +25^\circ\text{C}$ ,  $V_I = 48\text{ V}$ ,  
 $I_O = 30\text{ A}$  resistive load.

Trace: output voltage (100 mV/div.).  
 Time scale: (2 μs/div.).

#### Output Load Transient Response

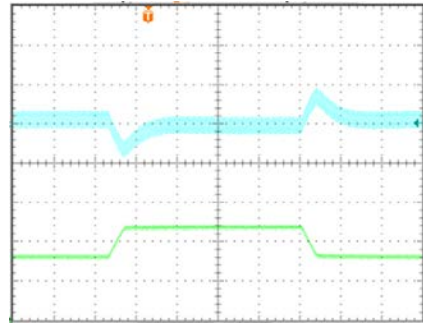

Output voltage response to load current step-change (15-22.5-15 A) at:  
 $T_{P1} = +25^\circ\text{C}$ ,  $V_I = 48\text{ V}$ .

Top trace: output voltage (200 mV/div.).  
 Bottom trace: load current (10 A/div.).  
 Time scale: (0.2 ms/div.).

#### Output Voltage Adjust (see operating information)

##### Passive adjust

The resistor value for an adjusted output voltage is calculated by using the following equations:

Output Voltage Adjust, Decrease:

$$R_{adj} = \left( \frac{16.31}{3.3 - V_o} - 10.2 \right) \text{ k}\Omega$$

Output Voltage Adjust, Increase:

$$R_{adj} = \left( \frac{13.3(V_o - 1.226)}{V_o - 3.3} - 10.2 \right) \text{ k}\Omega$$

Example: Increase 4% =>  $V_o = 3.432\text{ Vdc}$

$$\left( \frac{13.3 \times (3.432 - 1.226)}{3.432 - 3.3} - 10.2 \right) \text{ k}\Omega = 212.07 \text{ k}\Omega$$

**PKB 5000W series** Direct Converters  
 Input 18 - 75 V, Output up to 30 A / 120 W

28701- BMR 709 Rev. C November 2017

© Flex

**Typical Characteristics**  
**3.3 V, 30 A / 99 W**

**PKB 5110W PI**

**Output Current Derating – Open frame**

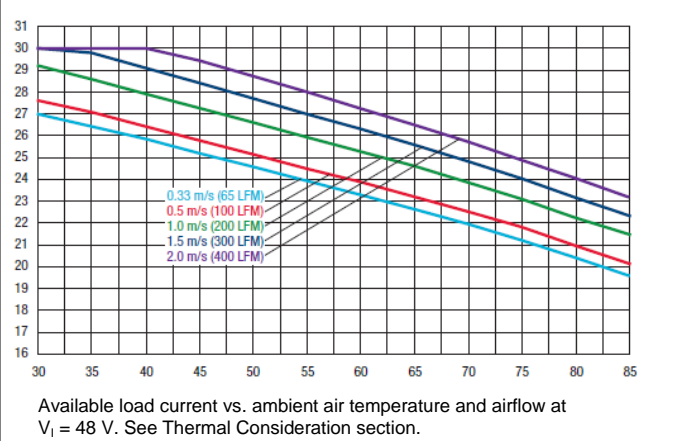

**Output Current Derating – Open frame**

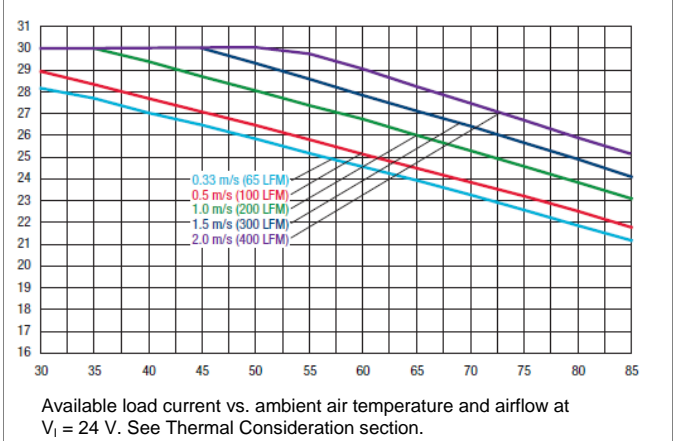

**Output Current Derating – Base plate**

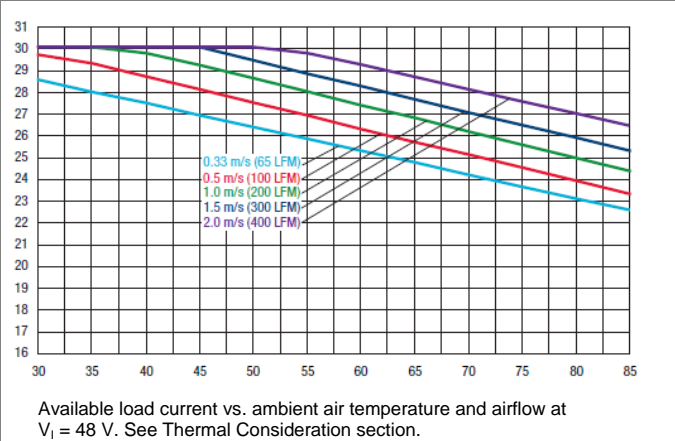

**Output Current Derating – Base plate**

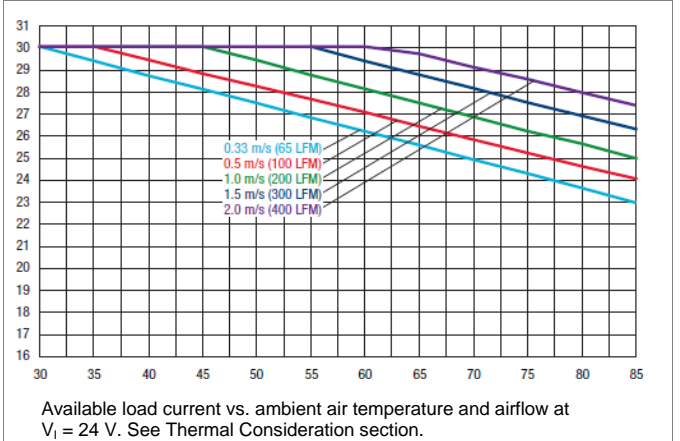

**Thermal Hot Spot**

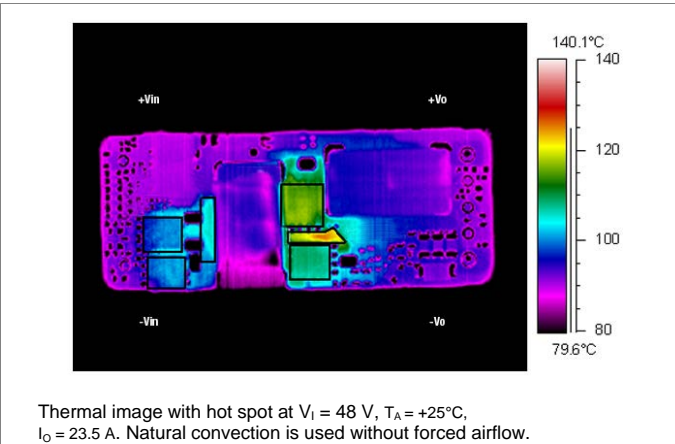



**PKB 5000W series Direct Converters**  
 Input 18 - 75 V, Output up to 30 A / 120 W

28701- BMR 709 Rev. C November 2017  
 © Flex

### Electrical Specification 5 V, 20 A / 100 W

**PKB 5111W PI**

$T_{P1} = -40$  to  $+85^{\circ}\text{C}$ ,  $V_I = 18$  to  $75$  V, sense pins connected to output pins unless otherwise specified under Conditions.  
 Typical values given at:  $T_{P1} = +25^{\circ}\text{C}$ ,  $V_I = 48$  V,  $I_O$ , unless otherwise specified under Conditions.  
 Additional  $C_{in} = 33 \mu\text{F}$ ,  $C_{out} = 1 \mu\text{F} + 10 \mu\text{F}$ . See Operating Information section for selection of capacitor types.

Characteristics		Conditions	min	typ	max	Unit
$V_I$	Input voltage range		18		75	V
$V_{loff}$	Turn-off input voltage	Decreasing input voltage	17	17.5	18	V
$V_{lon}$	Turn-on input voltage	Increasing input voltage	15.5	16	17.5	V
$P_O$	Output power		0		100	W
$\eta$	Efficiency	max $I_O$		90.5		%
		max $I_O$ , $V_I = 24$ V		92		
$P_d$	Power Dissipation	max $I_O$ , see Note 1		TBD		W
$I_{li}$	Input idling current	$I_O = 0$ A, $V_I = 48$ V		100		mA
$I_{RC}$	Input standby current	$V_I = 48$ V (turned off with RC)		5		mA
$f_s$	Switching frequency	0-100 % of max $I_O$ , see Note 2	200	225	250	kHz

$V_{oi}$	Output voltage initial setting and accuracy	$T_{P1} = +25^{\circ}\text{C}$ , $V_I = 48$ V, $I_O = 10$ A	4.95	5	5.05	V
$V_O$	Output adjust range	See operating information	4.5		5.5	V
	Output voltage tolerance band	0-100% of max $I_O$	4.95		5.05	V
	Line regulation	max $I_O$		$\pm 5$		mV
	Load regulation	$V_I = 48$ V, 0-100% of max $I_O$		$\pm 5$		mV
$V_{tr}$	Load transient voltage deviation	$V_I = 48$ V, Load step 50-75-50% of max $I_O$ , $di/dt = 10$ A/ $\mu\text{s}$		$\pm 450$		mV
$t_{tr}$	Load transient recovery time	see Note 3		100	200	$\mu\text{s}$
$t_s$	Start-up time (from $V_I$ connection to 90% of $V_{oi}$ )	0-100% of max $I_O$		20	30	ms
$t_{RC}$	RC start-up time	max $I_O$		20		ms
$I_O$	Output current		0		20	A
$I_{lim}$	Current limit threshold	$T_{P1} < \text{max } T_{P1}$	23	27	32	A
$I_{sc}$	Short circuit current	$T_{P1} = 25^{\circ}\text{C}$ , see Note 4		1.5	2.5	A
$C_{out}$	Recommended Capacitive Load	$T_{P1} = 25^{\circ}\text{C}$ , see Note 5	0		10000	$\mu\text{F}$
$V_{Oac}$	Output ripple & noise	See ripple & noise section, $V_{oi}$		75	110	mVp-p
OVP	Over voltage protection	$T_{P1} = +25^{\circ}\text{C}$ , $V_I = 48$ V, 0-100% of max $I_O$		6.5	7	V

Note 1: See power dissipation graph

Note 2: See Operating Information section

Note 3:  $C_{out} = 1 \mu\text{F} + 10 \mu\text{F} + 10000 \mu\text{F}$

Note 4: RMS current, See Operating Information section.

Note 5: See Operating Information section.

**PKB 5000W series** Direct Converters  
 Input 18 - 75 V, Output up to 30 A / 120 W

28701- BMR 709 Rev. C November 2017

© Flex

**Typical Characteristics**  
**5 V, 20 A / 100 W**

**PKB 5111W PI**

**Efficiency**

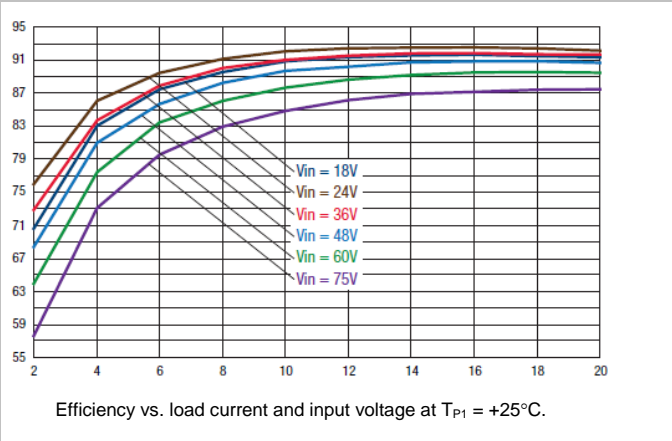

**Power Dissipation**

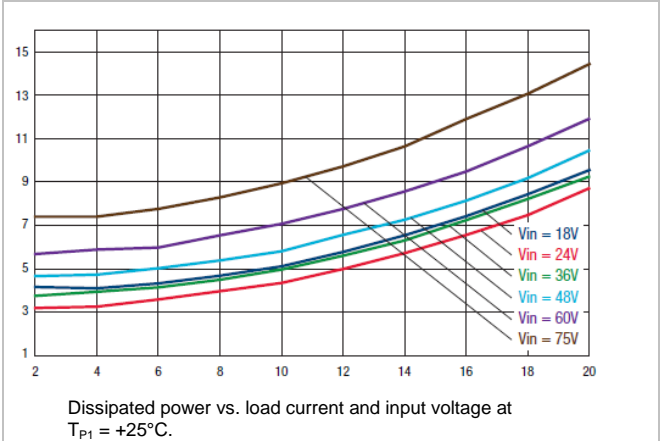

**PKB 5000W series** Direct Converters  
 Input 18 - 75 V, Output up to 30 A / 120 W

28701- BMR 709 Rev. C November 2017

© Flex

### Typical Characteristics 5 V, 20 A / 100 W

**PKB 5111W PI**

#### Start-up

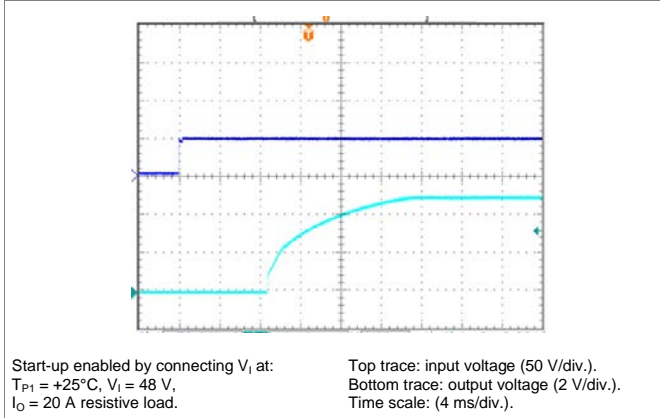

#### Shut-down

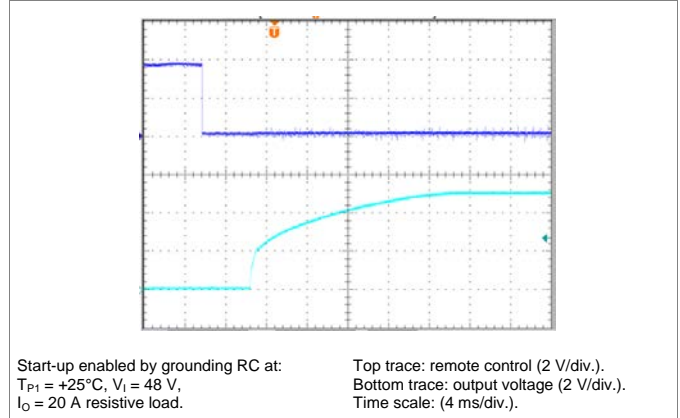

#### Output Ripple & Noise

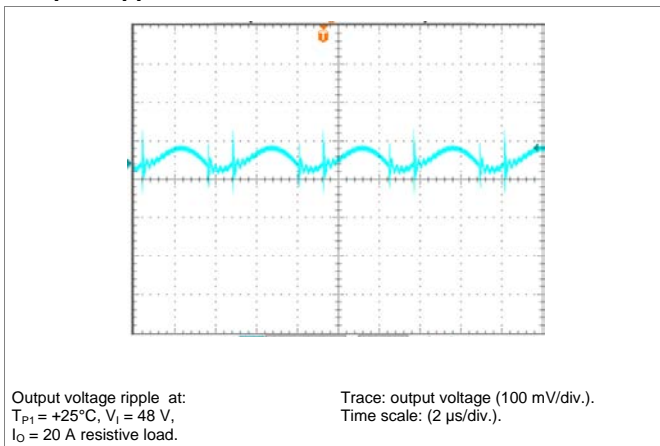

#### Output Load Transient Response

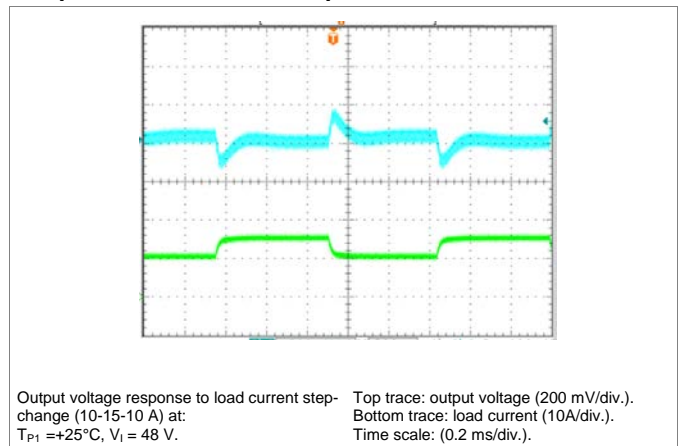

#### Output Voltage Adjust (see operating information)

##### Passive adjust

The resistor value for an adjusted output voltage is calculated by using the following equations:

Output Voltage Adjust, Decrease:

$$R_{adj} = \left( \frac{25.01}{5 - V_o} - 10.2 \right) \text{ k}\Omega$$

Output Voltage Adjust, Increase:

$$R_{adj} = \left( \frac{20.4(V_o - 1.226)}{V_o - 5} - 10.2 \right) \text{ k}\Omega$$

Example: Increase 4%  $\Rightarrow V_o = 5.2\text{ Vdc}$

$$\left( \frac{20.4 \times (5.2 - 1.226)}{5.2 - 5} - 10.2 \right) \text{ k}\Omega = 395.15 \text{ k}\Omega$$

**PKB 5000W series** Direct Converters  
 Input 18 - 75 V, Output up to 30 A / 120 W

28701- BMR 709 Rev. C November 2017

© Flex

**Typical Characteristics**  
**5 V, 20 A / 100 W**

**PKB 5111W PI**

**Output Current Derating – Open frame**

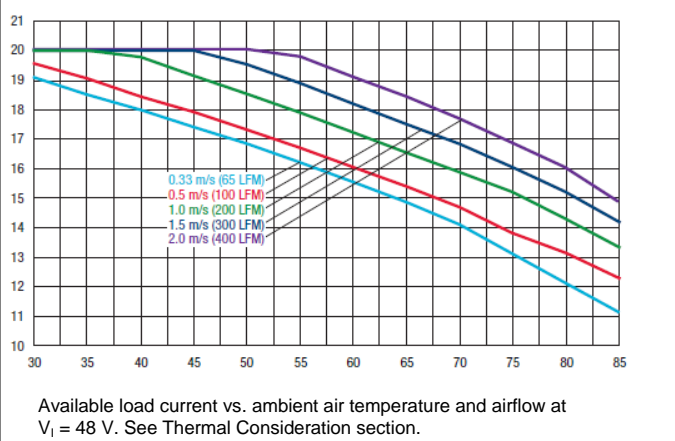

**Output Current Derating – Base plate**

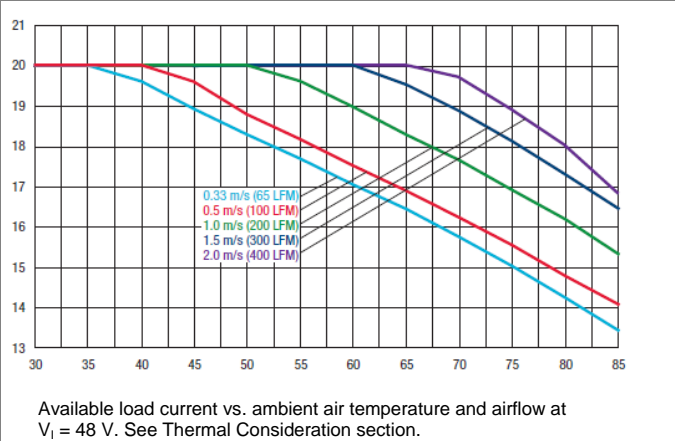

**Thermal Hot Spot**

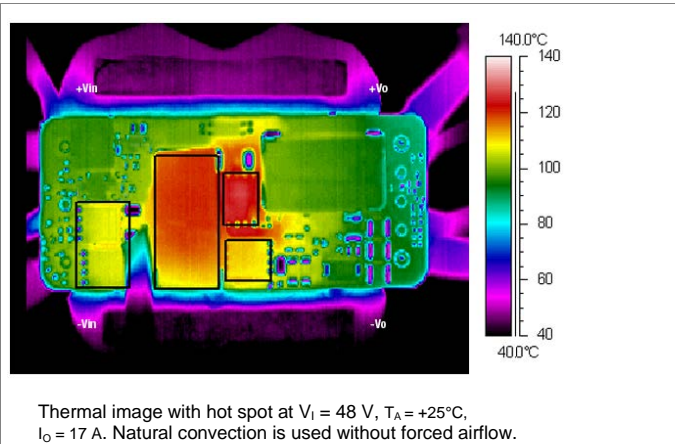

<b>PKB 5000W series Direct Converters</b> Input 18 - 75 V, Output up to 30 A / 120 W	28701- BMR 709 Rev. C November 2017
	© Flex

**Electrical Specification**  
**12 V, 10 A / 120 W**

**PKB 5113W PI**

$T_{P1} = -40$  to  $+85^{\circ}\text{C}$ ,  $V_I = 18$  to  $75$  V, sense pins connected to output pins unless otherwise specified under Conditions.  
 Typical values given at:  $T_{P1} = +25^{\circ}\text{C}$ ,  $V_I = 48$  V,  $I_O$  max, unless otherwise specified under Conditions.  
 Additional  $C_{in} = 33 \mu\text{F}$ ,  $C_{out} = 1 \mu\text{F} + 10 \mu\text{F}$ . See Operating Information section for selection of capacitor types.

Characteristics		Conditions	min	typ	max	Unit
$V_I$	Input voltage range		18		75	V
$V_{loff}$	Turn-off input voltage	Decreasing input voltage	16	16.45	17.5	V
$V_{lon}$	Turn-on input voltage	Increasing input voltage	17	17.5	17.9	V
$P_O$	Output power		0		120	W
$\eta$	Efficiency	max $I_O$		91.5		%
		max $I_O$ , $V_I = 24$ V		91.5		
$P_d$	Power Dissipation	max $I_O$ , see Note 1		TBD		W
$I_{li}$	Input idling current	$I_O = 0$ A, $V_I = 48$ V		110		mA
$I_{RC}$	Input standby current	$V_I = 48$ V (turned off with RC)		4		mA
$f_s$	Switching frequency	0-100 % of max $I_O$ , see Note 2	200	220	240	kHz

$V_{Oi}$	Output voltage initial setting and accuracy	$T_{P1} = +25^{\circ}\text{C}$ , $V_I = 48$ V, $I_O = 5$ A	11.88	12	12.12	V
$V_O$	Output adjust range	See operating information	10.8		13.2	V
	Output voltage tolerance band	0-100% of max $I_O$	11.88		12.12	V
	Line regulation	max $I_O$		$\pm 18$		mV
	Load regulation	$V_I = 48$ V, 0-100% of max $I_O$		$\pm 9$		mV
$V_{tr}$	Load transient voltage deviation	$V_I = 48$ V, Load step 50-75-50% of max $I_O$ , $di/dt = 5$ A/ $\mu\text{s}$		$\pm 650$		mV
$t_{tr}$	Load transient recovery time	see Note 3		100	200	$\mu\text{s}$
$t_s$	Start-up time (from $V_I$ connection to 90% of $V_{Oi}$ )	0-100% of max $I_O$		30	40	ms
$t_{RC}$	RC start-up time	max $I_O$		20		ms
$I_O$	Output current		0		10	A
$I_{lim}$	Current limit threshold	$T_{P1} < \text{max } T_{P1}$	11.5	12.5	14	A
$I_{sc}$	Short circuit current	$T_{P1} = 25^{\circ}\text{C}$ , see Note 4		1	2	A
$C_{out}$	Recommended Capacitive Load	$T_{P1} = 25^{\circ}\text{C}$ , see Note 5	0		4700	$\mu\text{F}$
$V_{Oac}$	Output ripple & noise	See ripple & noise section, $V_{Oi}$		115	200	mVp-p
OVP	Over voltage protection	$T_{P1} = +25^{\circ}\text{C}$ , $V_I = 48$ V, 0-100% of max $I_O$		15	16	V

Note 1: See power dissipation graph

Note 2: See Operating Information section

Note 3:  $C_{out} = 1 \mu\text{F} + 10 \mu\text{F} + 4700\mu\text{F}$

Note 4: RMS current, See Operating Information section.

Note 5: See Operating Information section.

**PKB 5000W series** Direct Converters  
 Input 18 - 75 V, Output up to 30 A / 120 W

28701- BMR 709 Rev. C November 2017

© Flex

**Typical Characteristics**  
**12 V, 10 A / 120 W**

**PKB 5113W PI**

**Efficiency**

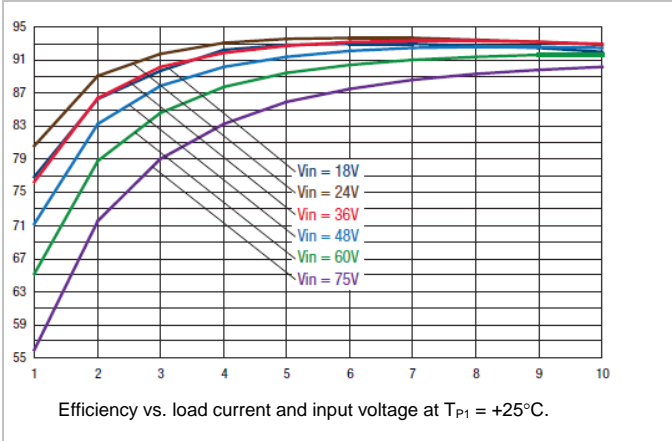

**Power Dissipation**

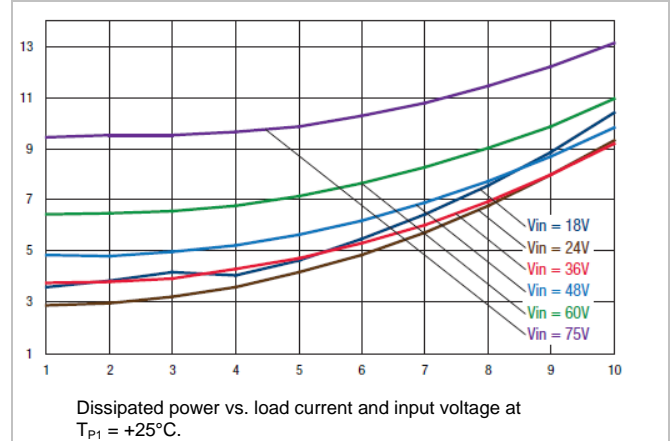

**PKB 5000W series** Direct Converters  
 Input 18 - 75 V, Output up to 30 A / 120 W

28701- BMR 709 Rev. C November 2017  
 © Flex

**Typical Characteristics**  
**12 V, 10 A / 120 W**

**PKB 5113W PI**

**Start-up**

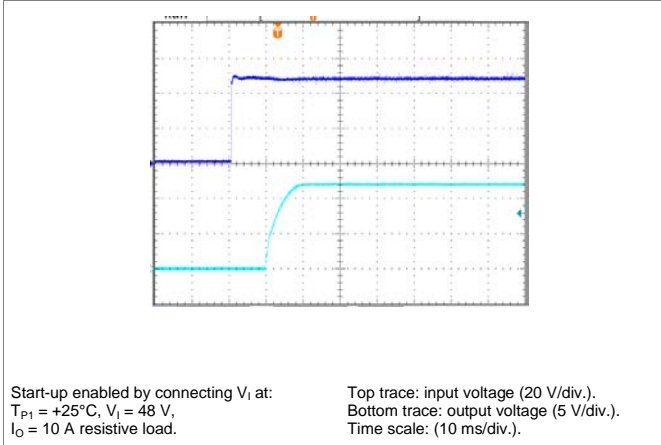

**Start-up**

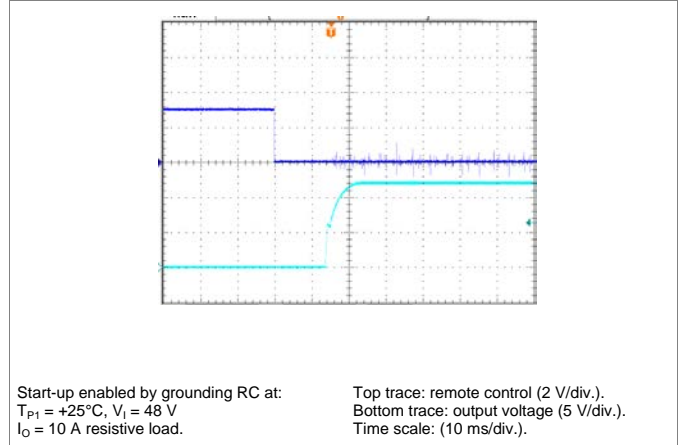

**Output Ripple & Noise**

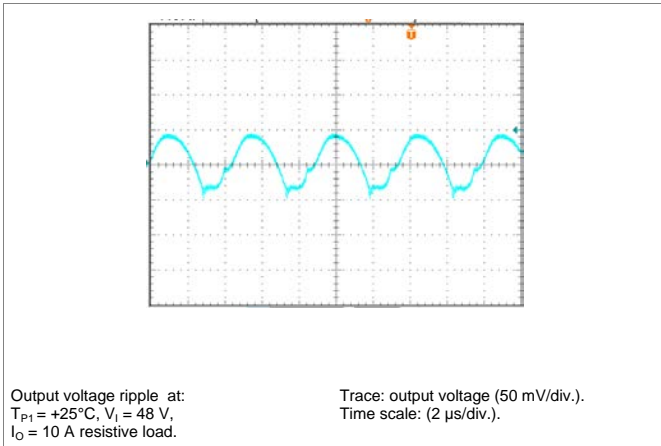

**Output Load Transient Response**

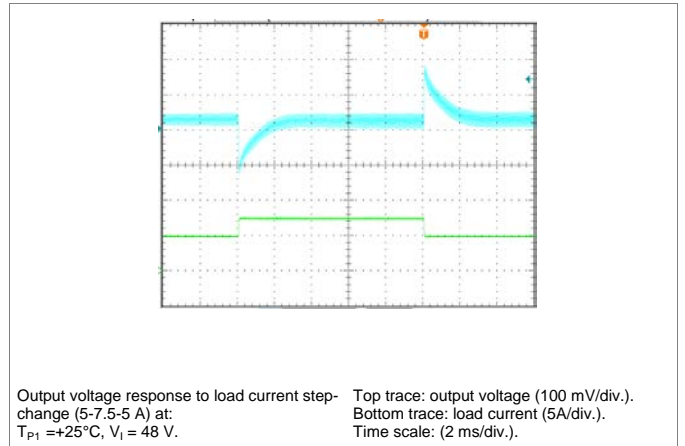

**Output Voltage Adjust (see operating information)**

**Passive adjust**

The resistor value for an adjusted output voltage is calculated by using the following equations:

Output Voltage Adjust, Decrease:

$$R_{adj} = \left( \frac{60.45}{12 - V_o} - 10.2 \right) \text{ k}\Omega$$

Output Voltage Adjust, Increase:

$$R_{adj} = \left( \frac{49.6(V_o - 1.226)}{V_o - 12} - 10.2 \right) \text{ k}\Omega$$

Example: Increase 4% =>  $V_o = 12.48\text{ Vdc}$

$$\left( \frac{49.6 \times (12.48 - 1.226)}{12.48 - 12} - 10.2 \right) \text{ k}\Omega = 1152.7 \text{ k}\Omega$$

**PKB 5000W series** Direct Converters  
 Input 18 - 75 V, Output up to 30 A / 120 W

28701- BMR 709 Rev. C November 2017

© Flex

**Typical Characteristics**  
**12 V, 10 A / 120 W**

**PKB 5113W PI**

**Output Current Derating – Open frame**

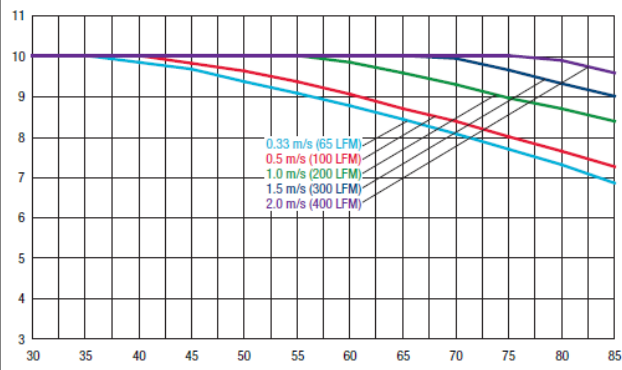

Available load current vs. ambient air temperature and airflow at  $V_i = 48$  V. See Thermal Consideration section.

**Output Current Derating – Open frame**

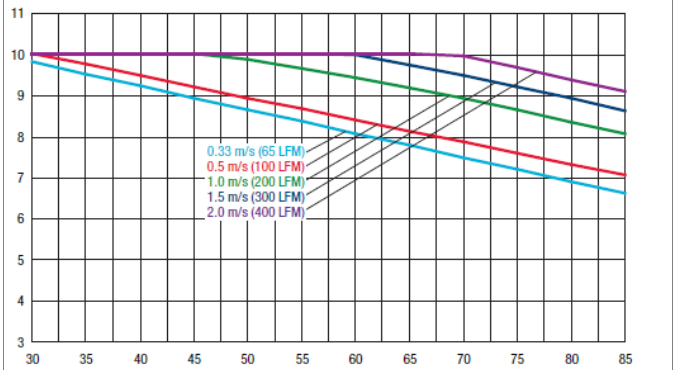

Available load current vs. ambient air temperature and airflow at  $V_i = 24$  V. See Thermal Consideration section.

**Output Current Derating – Base plate**

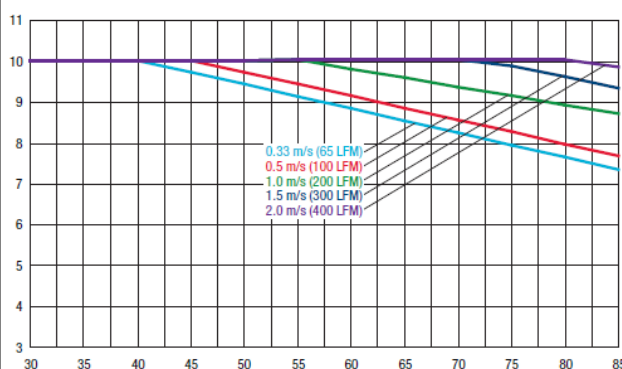

Available load current vs. ambient air temperature and airflow at  $V_i = 48$  V. See Thermal Consideration section.

**Output Current Derating – Base plate**

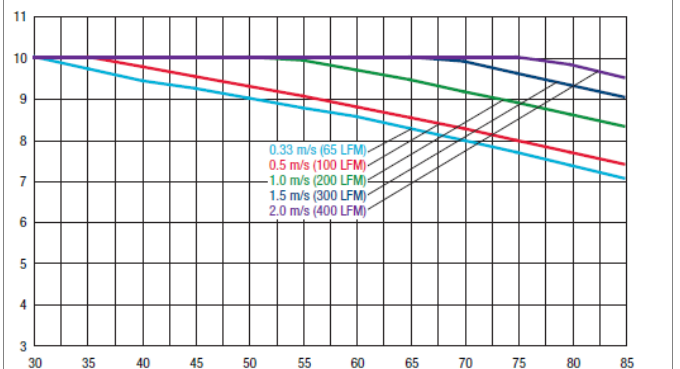

Available load current vs. ambient air temperature and airflow at  $V_i = 24$  V. See Thermal Consideration section.

**Thermal Hot Spot**

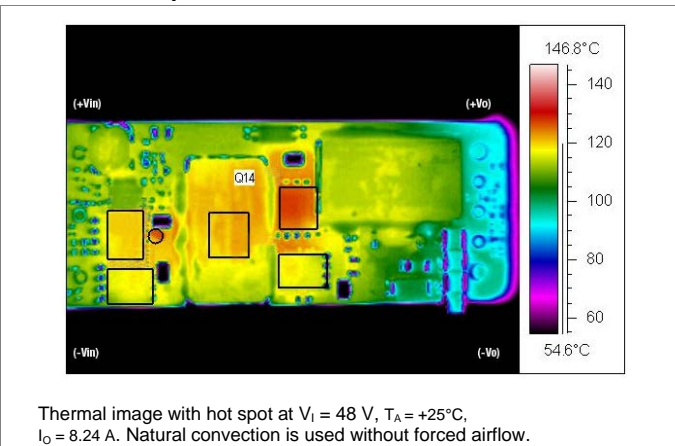

Thermal image with hot spot at  $V_i = 48$  V,  $T_A = +25^\circ\text{C}$ ,  $I_O = 8.24$  A. Natural convection is used without forced airflow.



**PKB 5000W series Direct Converters**  
 Input 18 - 75 V, Output up to 30 A / 120 W

28701- BMR 709 Rev. C November 2017

© Flex

### EMC Specification

Conducted EMI measured according to EN55022, CISPR 22 and FCC part 15J (see test set-up). See Design Note 009 for further information. The fundamental switching frequency is 220 kHz for PKB 5113 WPI at  $V_i = 48\text{ V}$  and max  $I_o$ .

### Conducted EMI Input terminal value (typ)

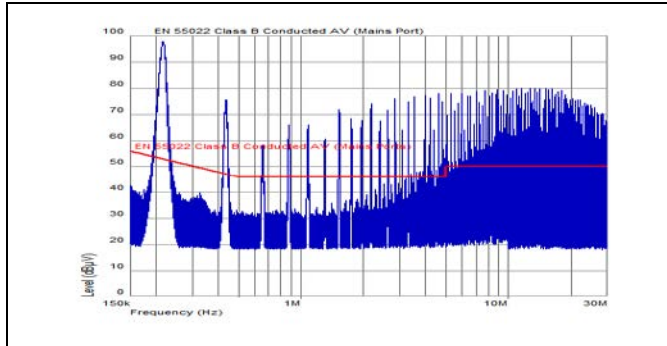

EMI without filter

### Optional external filter for class B

Suggested external input filter in order to meet class B in EN 55022, CISPR 22 and FCC part 15J.

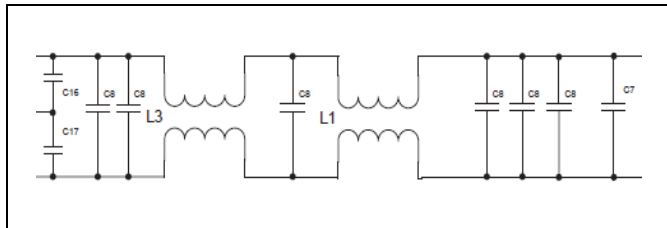

Filter components:

C1,2,8 = 2.2  $\mu\text{F}$  from Murata

C7 = 22  $\mu\text{F}$ , 100V from Panasonic

C16,17 = 0.22  $\mu\text{F}$

L1 = 1mH, 6A, Pulse PE-62913

L3 = 500  $\mu\text{H}$ , 10A, Murata 500  $\mu\text{H}$ , 10A, MPS

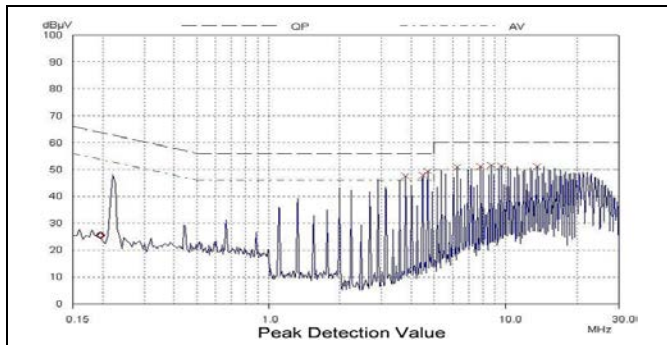

EMI with filter

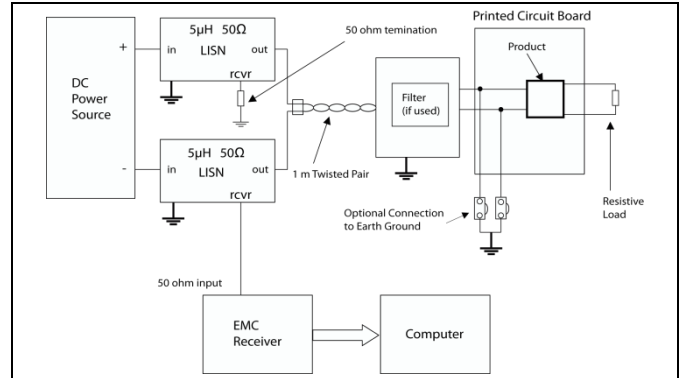

Test set-up

### Layout recommendations

The radiated EMI performance of the product will depend on the PWB layout and ground layer design. It is also important to consider the stand-off of the product. If a ground layer is used, it should be connected to the output of the product and the equipment ground or chassis.

A ground layer will increase the stray capacitance in the PWB and improve the high frequency EMC performance.

### Output ripple and noise

Output ripple and noise measured according to figure below. See Design Note 022 for detailed information.

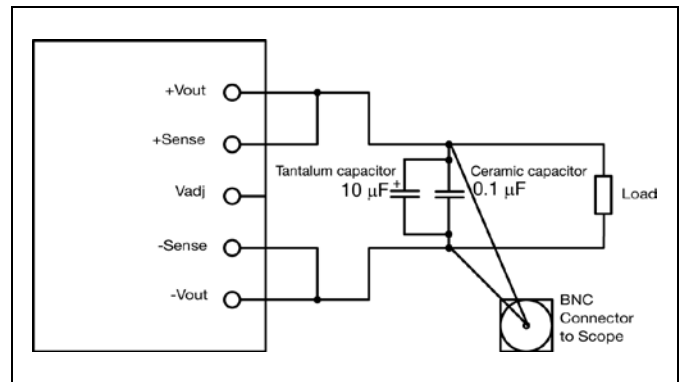

Output ripple and noise test setup

**PKB 5000W series Direct Converters**  
Input 18 - 75 V, Output up to 30 A / 120 W

28701- BMR 709 Rev. C November 2017

© Flex

## Operating information

### Input Voltage

The input voltage range 18 to 75 Vdc meets the requirements of the European Telecom Standard ETS 300 132-2 for normal input voltage range in -48 and -60 Vdc systems, -40.5 to -57.0 V and -50.0 to -72 V respectively. At input voltages exceeding 75 V, the power loss will be higher than at normal input voltage. The absolute maximum continuous input voltage is 80 Vdc.

Short duration transient disturbances can occur on the DC distribution and input of the product when a short circuit fault occurs on the equipment side of a protective device (fuse or circuit breaker). The voltage level, duration and energy of the disturbance are dependent on the particular DC distribution network characteristics and can be sufficient to damage the product unless measures are taken to suppress or absorb this energy. The transient voltage can be limited by capacitors and other energy absorbing devices like zener diodes connected across the positive and negative input conductors at a number of strategic points in the distribution network. The end-user must secure that the transient voltage will not exceed the value stated in the Absolute maximum ratings. ETSI TR 100 283 examines the parameters of DC distribution networks and provides guidelines for controlling the transient and reduce its harmful effect.

### Turn-off Input Voltage

The products monitor the input voltage and will turn on and turn off at predetermined levels. The minimum hysteresis between turn on and turn off input voltage is 1 V.

### Remote Control (RC)

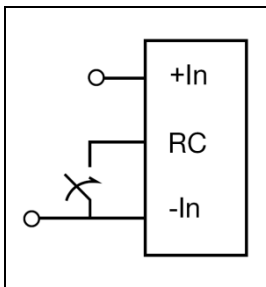

The products are fitted with a remote control function referenced to the primary negative input connection (-In), with negative and positive logic options available. The RC function allows the product to be turned on/off by an external device like a semiconductor or mechanical switch.

The external device must provide a minimum required sink current to guarantee a voltage not higher than maximum voltage on the RC pin (see Electrical characteristics table). When the RC pin is left open, the voltage generated on the RC pin is 3.5 – 15 V.

The standard product is provided with “negative logic” RC and will be off until the RC pin is connected to the -In. To turn off the product the RC pin should be left open, or connected to a voltage higher than 3.5 V referenced to -In. In situations where it is desired to have the product to power up automatically without the need for control signals or a switch, the RC pin can

be wired directly to -In.

The second option is “positive logic” remote control, which can be ordered by adding the suffix “P” to the end of the part number. When the RC pin is left open, the product starts up automatically when the input voltage is applied. Turn off is achieved by connecting the RC pin to the -In. The product will restart automatically when this connection is opened.

See Design Note 021 for detailed information.

### Input and Output Impedance

The impedance of both the input source and the load will interact with the impedance of the product. It is important that the input source has low characteristic impedance. The products are designed for stable operation without external capacitors connected to the input or output. The performance in some applications can be enhanced by addition of external capacitance as described under External Decoupling Capacitors.

If the input voltage source contains significant inductance, the addition of a 22 - 100  $\mu$ F capacitor across the input of the product will ensure stable operation. The capacitor is not required when powering the product from an input source with an inductance below 10  $\mu$ H. The minimum required capacitance value depends on the output power and the input voltage. The higher output power the higher input capacitance is needed. Approximately doubled capacitance value is required for a 24 V input voltage source compared to a 48 V input voltage source.

### External Decoupling Capacitors

When powering loads with significant dynamic current requirements, the voltage regulation at the point of load can be improved by addition of decoupling capacitors at the load. The most effective technique is to locate low ESR ceramic and electrolytic capacitors as close to the load as possible, using several parallel capacitors to lower the effective ESR. The ceramic capacitors will handle high-frequency dynamic load changes while the electrolytic capacitors are used to handle low frequency dynamic load changes. It is equally important to use low resistance and low inductance PWB layouts and cabling.

External decoupling capacitors will become part of the product's control loop. The control loop is optimized for a wide range of external capacitance and the maximum recommended value that could be used without any additional analysis is found in the Electrical specification.

The ESR of the capacitors is a very important parameter. Stable operation is guaranteed with a verified ESR value of  $>5$  m $\Omega$  across the output connections.

For further information please contact your local Flex Power Modules representative.

**PKB 5000W series Direct Converters**  
Input 18 - 75 V, Output up to 30 A / 120 W

28701- BMR 709 Rev. C November 2017

© Flex

### Output Voltage Adjust ( $V_{adj}$ )

The products have an Output Voltage Adjust pin ( $V_{adj}$ ). This pin can be used to adjust the output voltage above or below Output voltage initial setting.

When increasing the output voltage, the voltage at the output pins (including any remote sense compensation ) must be kept below the threshold of the over voltage protection, (OVP) to prevent the product from shutting down. At increased output voltages the maximum power rating of the product remains the same, and the max output current must be decreased correspondingly.

To increase the voltage the resistor should be connected between the  $V_{adj}$  pin and +Sense pin. The resistor value of the Output voltage adjust function is according to information given under the Output section for the respective product.

To decrease the output voltage, the resistor should be connected between the  $V_{adj}$  pin and -Sense pin.

### Over Current Protection (OCP)

The products include current limiting circuitry for protection at continuous overload. The output voltage will decrease towards zero for output currents in excess of max output current (max  $I_o$ ). The product will resume normal operation after removal of the overload. The load distribution should be designed for the maximum output short circuit current specified.

### Pre-bias Start-up

The product has a Pre-bias start up functionality and will not sink current during start up if a pre-bias source is present at the output terminals.

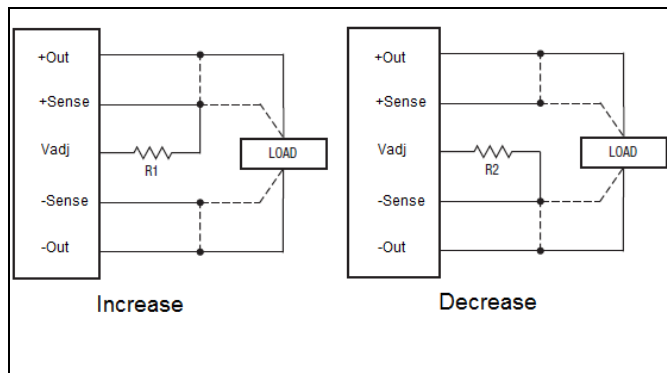

### Remote Sense

The products have remote sense that can be used to compensate for voltage drops between the output and the point of load. The sense traces should be located close to the PWB ground layer to reduce noise susceptibility. The remote sense circuitry will compensate for up to 5% voltage drop between output pins and the point of load.

If the remote sense is not needed +Sense should be connected to +Out and -Sense should be connected to -Out.

### Over Temperature Protection (OTP)

The products are protected from thermal overload by an internal over temperature shutdown circuit. When  $T_{P1}$  as defined in thermal consideration section exceeds 140°C the product will shut down. The product will make continuous attempts to start up (non-latching mode) and resume normal operation automatically when the temperature has dropped >10°C below the temperature threshold.

### Over Voltage Protection (OVP)

The products have output over voltage protection that will shut down the product in over voltage conditions. The product will make continuous attempts to start up (non-latching mode) and resume normal operation automatically after removal of the over voltage condition.

**PKB 5000W series Direct Converters**  
 Input 18 - 75 V, Output up to 30 A / 120 W

28701- BMR 709 Rev. C November 2017

© Flex

## Thermal Consideration

### General

The products are designed to operate in different thermal environments and sufficient cooling must be provided to ensure reliable operation.

For products mounted on a PWB without a heat sink attached, cooling is achieved mainly by conduction, from the pins to the host board, and convection, which is dependent on the airflow across the product. Increased airflow enhances the cooling of the product. The Output Current Derating graph found in the Output section for each model provides the available output current vs. ambient air temperature and air velocity at  $V_I = 48\text{ V}$ .

The product is tested on a 10" x 10" test board mounted vertically in a wind tunnel.

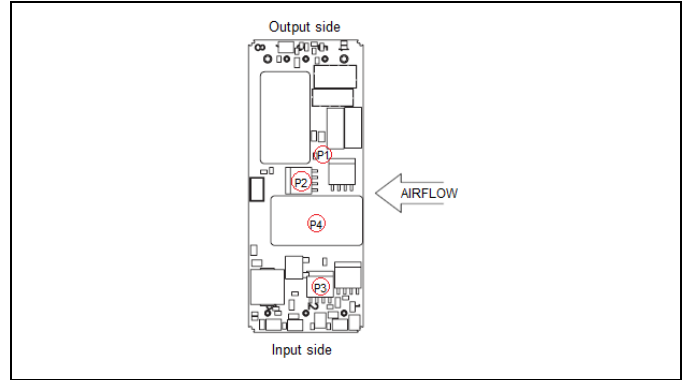
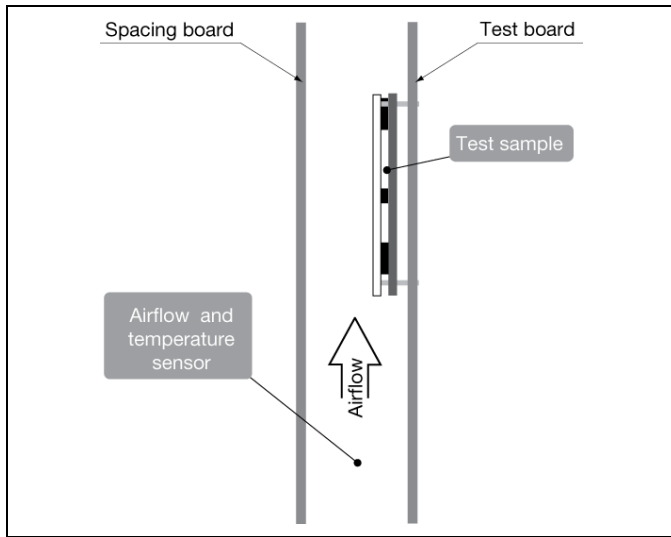

Open frame

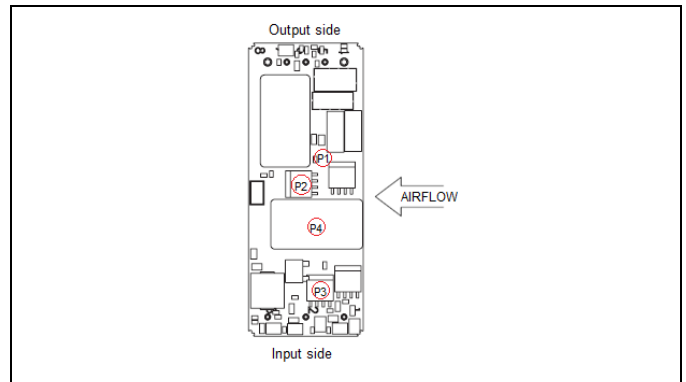

Base plate

### Definition of product operating temperature

The product operating temperatures is used to monitor the temperature of the product, and proper thermal conditions can be verified by measuring the temperature at positions P1, P2, P3 and P4. The temperature at these positions ( $T_{P1}$ ,  $T_{P2}$ ,  $T_{P3}$ ,  $T_{P4}$ ) should not exceed the maximum temperatures in the table below. The number of measurement points may vary with different thermal design and topology. Temperatures above maximum  $T_{P1}$ , measured at the reference point P1 are not allowed and may cause permanent damage.

Position	Description	Max Temp.
P1	Reference point	$T_{P1}=110^{\circ}\text{ C}$
P2	Mosfet case	$T_{P2}=120^{\circ}\text{ C}$
P3	Mosfet case	$T_{P3}=120^{\circ}\text{ C}$
P4	Transformer core	$T_{P4}=120^{\circ}\text{ C}$

**PKB 5000W series** Direct Converters  
 Input 18 - 75 V, Output up to 30 A / 120 W

28701- BMR 709 Rev. C November 2017

© Flex

### Connections

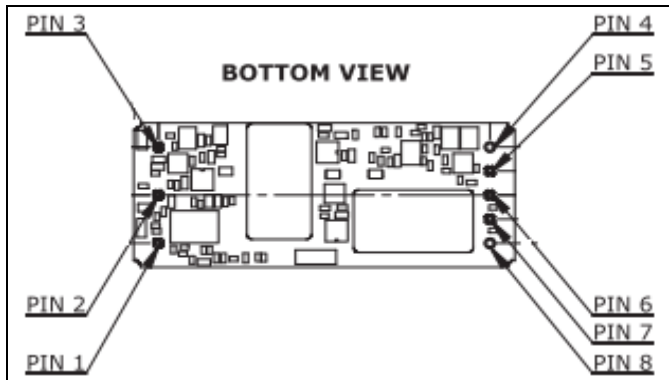

Pin	Designation	Function
1	+In	Positive input
2	RC	Remote control
3	-In	Negative input
4	-Out	Negative output
5	-Sense	Negative remote sense
6	V <sub>adj</sub>	Output voltage adjust
7	+Sense	Positive remote sense
8	+Out	Positive output

**PKB 5000W series Direct Converters**  
 Input 18 - 75 V, Output up to 30 A / 120 W

28701- BMR 709 Rev. C November 2017

© Flex

**Mechanical Information -Open Frame Version**

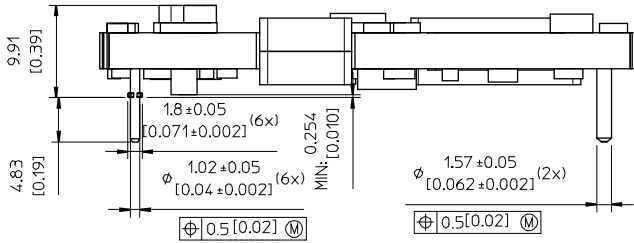
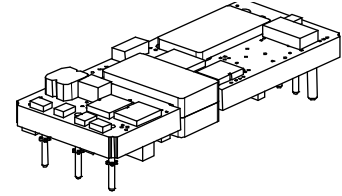

TOP VIEW

Pin position according to recommended footprint



Note 1

Pins

Pin 1~3, 5~7 Material: C26000, Brass,3/4 Hard

Pin 4,8 Material: C10200 Copper alloy, Full Hard

Plating: Min 5 MICRONS Au over 50 MICRONS nickel

Note 2

Recommended keep away area for user components to withstand input to output isolation voltage according to absolute maximum ratings.

Footprint:

Recommended hole dimensions are only for reference It's end users' decision based on different situations like productions process, substrate thickness,etc

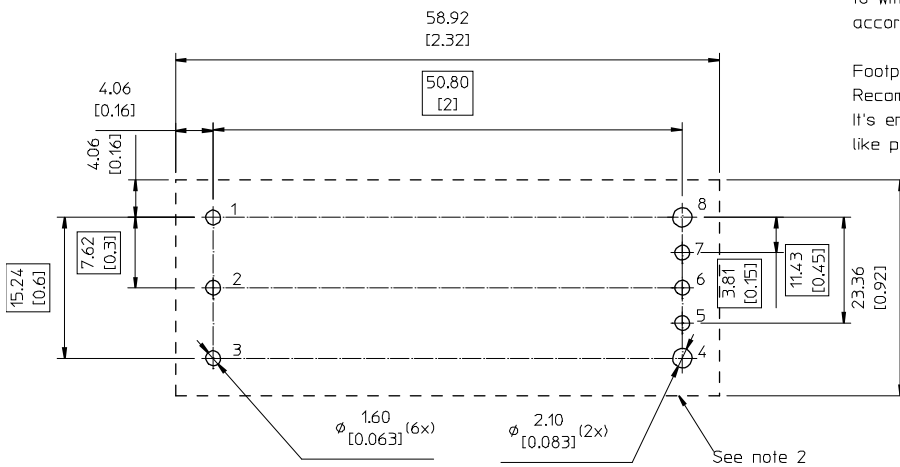

Weight: typical 20 g

All dimensions in mm [inch].

Tolerances unless specified

x.x mm ±0.50 mm [0.02], x.xx mm ±0.25 mm [0.01] (not applied on footprint or typical values)



**PKB 5000W series Direct Converters**  
 Input 18 - 75 V, Output up to 30 A / 120 W

28701- BMR 709 Rev. C November 2017

© Flex

**Mechanical Information - Base Plate Version**

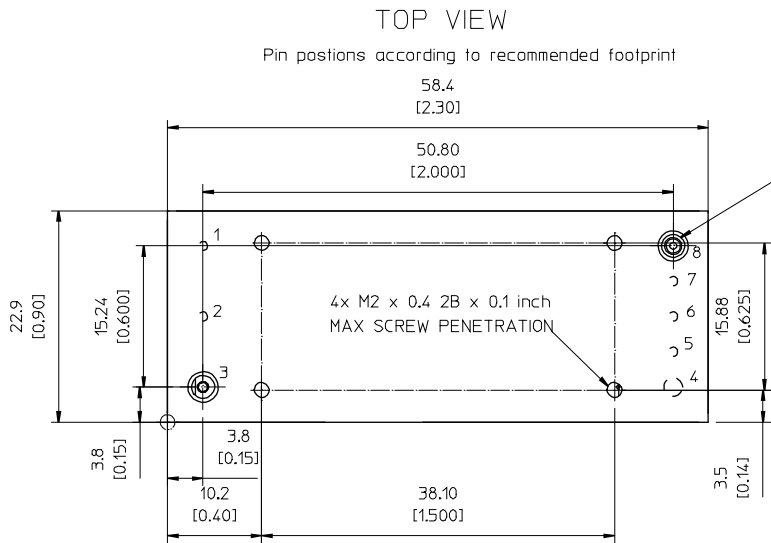
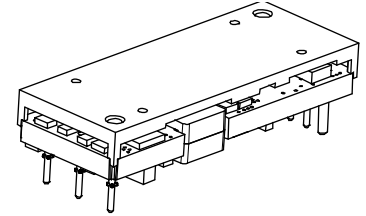
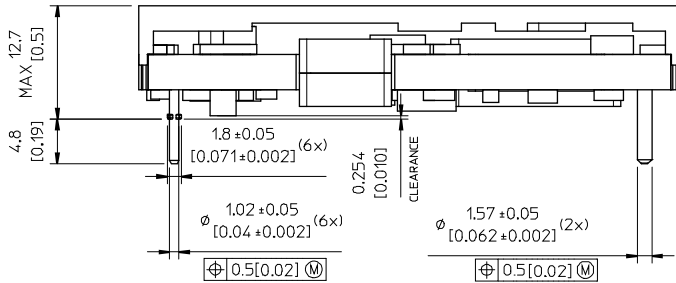

2x M3 x 0.5 2B x 0.13 inch  
 MAX SCREW PENETRATION

Note 1  
 Case  
 Material: Aluminum

Pins  
 Pin 1-3, 5-7 Material: C26000 Brass, 3/4 Hard  
 Pin 4, 8 Material: C10200 Copper alloy, Full Hard  
 Plating: Min 5 MICRINCHES Au over 50 MICRINCHES nickel

Note 2

Recommended keep away area for user components to withstand input to output isolation voltage according to absolute maximum ratings.

Footprint:  
 Recommended hole dimensions are only for reference It's end users' decision based on different situations like productions process, substrate thickness, etc

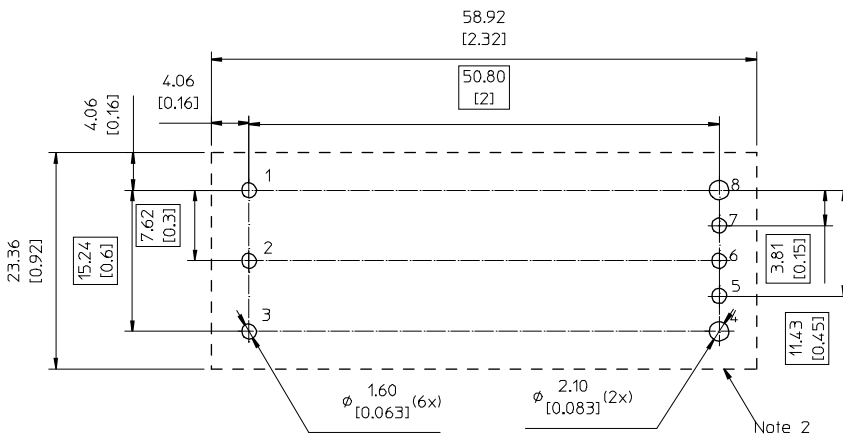

Weight: typical 36.5 g  
 All dimensions in mm [inch].  
 Tolerances unless specified  
 x.x mm ±0.5 mm [0.02], x.xx mm ±0.25 mm [0.01]  
 (not applied on footprint or typical values)

**PKB 5000W series Direct Converters**  
 Input 18 - 75 V, Output up to 30 A / 120 W

28701- BMR 709 Rev. C November 2017

© Flex

### Soldering Information - Hole Mounting

The hole mounted product is intended for plated through hole mounting by wave or manual soldering. The pin temperature is specified to maximum to 270°C for maximum 10 seconds.

A maximum preheat rate of 4°C/s and maximum preheat temperature of 150°C is suggested. When soldering by hand, care should be taken to avoid direct contact between the hot soldering iron tip and the pins for more than a few seconds in order to prevent overheating.

A no-clean flux is recommended to avoid entrapment of cleaning fluids in cavities inside the product or between the product and the host board. The cleaning residues may affect long time reliability and isolation voltage.

### Delivery Package Information

The products are delivered in antistatic trays

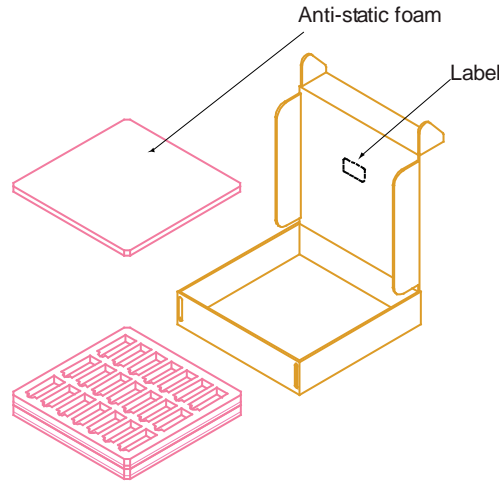

Tray Specifications	
<b>Material</b>	Antistatic Polyethylene Foam
<b>Surface resistance</b>	$10^4 < \text{Ohm/square} < 10^{11}$
<b>Bakability</b>	The trays are not bakable
<b>Tray thickness</b>	TBD
<b>Box capacity</b>	42 products (2 full trays/box)
<b>Tray weight</b>	TBD

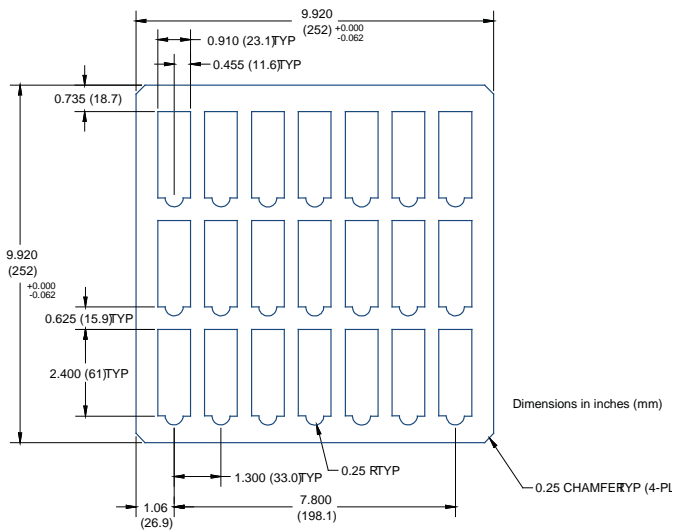



**PKB 5000W series** Direct Converters  
Input 18 - 75 V, Output up to 30 A / 120 W

28701- BMR 709 Rev. C November 2017

© Flex

### Product Qualification Specification

Characteristics			
External visual inspection	IPC-A-610		
Change of temperature (Temperature cycling)	IEC 60068-2-14 Na	Temperature range Number of cycles Dwell/transfer time	-40 to 100°C 1000 15 min/0-1 min
Cold (in operation)	IEC 60068-2-1 Ad	Temperature T <sub>A</sub> Duration	-45°C 72 h
Damp heat	IEC 60068-2-67 Cy	Temperature Humidity Duration	85°C 85 % RH 1000 hours
Dry heat	IEC 60068-2-2 Bd	Temperature Duration	125°C 1000 h
Electrostatic discharge susceptibility	IEC 61340-3-1, JESD 22-A114 IEC 61340-3-2, JESD 22-A115	Human body model (HBM) Machine Model (MM)	Class 2, 2000 V Class 3, 200 V
Immersion in cleaning solvents	IEC 60068-2-45 XA, method 2	Water Glycol ether	55°C 35°C
Mechanical shock	IEC 60068-2-27 Ea	Peak acceleration Duration	100 g 6 ms
Moisture reflow sensitivity <sup>1</sup>	J-STD-020C	Level 1 (SnPb-eutectic) Level 3 (Pb Free)	225°C 260°C
Operational life test	MIL-STD-202G, method 108A	Duration	1000 h
Resistance to soldering heat <sup>2</sup>	IEC 60068-2-20 Tb, method 1A	Solder temperature Duration	270°C 10-13 s
Robustness of terminations	IEC 60068-2-21 Test Ua1 IEC 60068-2-21 Test Ue1	Through hole mount products Surface mount products	All leads All leads
Solderability	IEC 60068-2-58 test Td <sup>1</sup>	Preconditioning Temperature, SnPb Eutectic Temperature, Pb-free	150°C dry bake 16 h 215°C 235°C
	IEC 60068-2-20 test Ta <sup>2</sup>	Preconditioning Temperature, SnPb Eutectic Temperature, Pb-free	Steam ageing 235°C 245°C
Vibration, broad band random	IEC 60068-2-64 Fh, method 1	Frequency Spectral density Duration	10 to 500 Hz 0.07 g <sup>2</sup> /Hz 10 min in each direction

#### Notes

<sup>1</sup> Only for products intended for reflow soldering (surface mount products)

<sup>2</sup> Only for products intended for wave soldering (plated through hole products)