

FEMALE-FEMALE BULKHEAD ADAPTER

R143.730.700

PANEL SEAL

Series : TNC-18

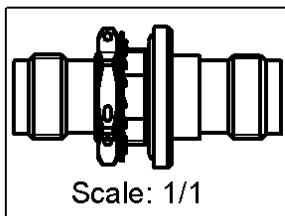
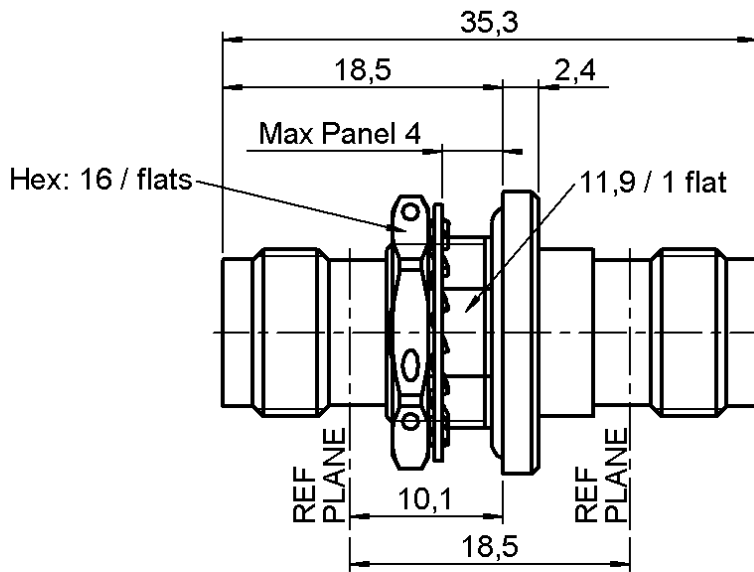

PANEL CUT OUT

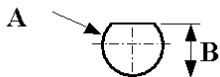

mm		
	Maxi	mini
A	12.8	12.7
B	12.1	12

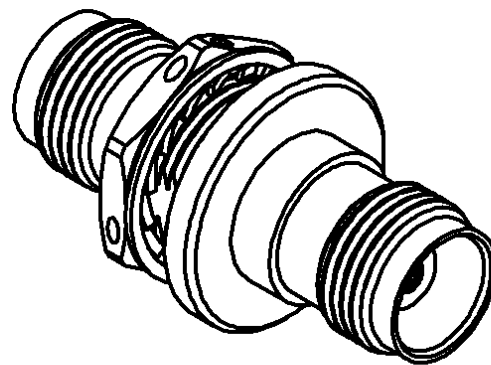

All dimensions are in mm.



COMPONENTS	MATERIALS	PLATINGS (µm)
BODY	STAINLESS STEEL	PASSIVATED .
CENTER CONTACT	BERYLLIUM COPPER	GOLD 2.5 OVER NICKEL 2
OUTER CONTACT	-	-
INSULATOR	PTFE	-
GASKET	-	-
OTHERS PARTS	STAINLESS STEEL	PASSIVATED .
-	-	-
-	-	-

Issue : 0408 B

In the effort to improve our products, we reserve the right to make changes judged to be necessary.



FEMALE-FEMALE BULKHEAD ADAPTER

R143.730.700

PANEL SEAL

Series : **TNC-18**

PACKAGING

SPECIFICATION

Standard	Unit	Other
1	-	Contact us

ELECTRICAL CHARACTERISTICS

ENVIRONMENTAL

Impedance		50 Ω
Frequency		0-18 GHz
VSWR	1.30 +	0.000 x F(GHz) Maxi
Insertion loss		0.06 √F(GHz) dB Maxi
RF leakage	- (57 - F(GHz)) dB Maxi
Voltage rating		500 Veff Maxi
Dielectric withstanding voltage		1500 Veff mini
Insulation resistance		5000 MΩ mini

Operating temperature	-65/+165 ° C
Hermetic seal	NA Atm.cm3/s
Panel leakage	NA

OTHERS CHARACTERISTICS

Assembly instruction

Others :

MECHANICAL CHARACTERISTICS

Center contact retention		
Axial force – Mating end		27 N mini
Axial force – Opposite end		27 N mini
Torque		NA N.cm mini
Recommended torque		
Mating		NA N.cm
Panel nut		250 N.cm
Mating life		500 Cycles mini
Weight		21.267 g

Issue : 0408 B

In the effort to improve our products, we reserve the right to make changes judged to be necessary.

