

3A, 600V Ultra Fast Surface Mount Rectifier

FEATURES

- Planar technology
- Low power loss, high efficiency
- Ideal for automated placement
- Moisture sensitivity level: level 1, per J-STD-020
- RoHS Compliant
- Halogen-free according to IEC 61249-2-21

APPLICATIONS

- DC to DC converter
- Switching mode converters and inverters
- Lighting application
- Snubber
- Freewheeling application

MECHANICAL DATA

- Case: DO-214AA (SMB)
- Molding compound meets UL 94V-0 flammability rating
- Terminal: Matte tin plated leads, solderable per J-STD-002
- Meet JESD 201 class 2 whisker test
- Polarity: Indicated by cathode band
- Weight: 0.087g (approximately)

KEY PARAMETERS		
PARAMETER	VALUE	UNIT
I_F	3	A
V_{RRM}	600	V
I_{FSM}	45	A
T_{JMAX}	150	°C
Package	DO-214AA (SMB)	
Configuration	Single die	



DO-214AA (SMB)



ABSOLUTE MAXIMUM RATINGS ($T_A = 25^\circ\text{C}$ unless otherwise noted)			
PARAMETER	SYMBOL	PU3JB	UNIT
Marking code on the device		PU3JB	
Repetitive peak reverse voltage	V_{RRM}	600	V
Reverse voltage, total rms value	$V_{R(RMS)}$	420	V
Forward current	I_F	3	A
Surge peak forward current single half sine-wave superimposed on rated load	$t = 8.3\text{ms}$	45	A
	$t = 1.0\text{ms}$	100	
Junction temperature	T_J	-55 to +150	°C
Storage temperature	T_{STG}	-55 to +150	°C

THERMAL PERFORMANCE			
PARAMETER	SYMBOL	TYP	UNIT
Junction-to-lead thermal resistance	$R_{\theta JL}$	14	°C/W
Junction-to-ambient thermal resistance	$R_{\theta JA}$	68	°C/W
Junction-to-case thermal resistance	$R_{\theta JC}$	16	°C/W

Thermal Performance Note: Units mounted on PCB (10mm x 10mm Cu pad test board)

ELECTRICAL SPECIFICATIONS ($T_A = 25^\circ\text{C}$ unless otherwise noted)					
PARAMETER	CONDITIONS	SYMBOL	TYP	MAX	UNIT
Forward voltage ⁽¹⁾	$I_F = 1.5\text{A}, T_J = 25^\circ\text{C}$	V_F	1.27	-	V
	$I_F = 3.0\text{A}, T_J = 25^\circ\text{C}$		1.43	1.7	V
	$I_F = 1.5\text{A}, T_J = 125^\circ\text{C}$		0.99	-	V
	$I_F = 3.0\text{A}, T_J = 125^\circ\text{C}$		1.16	-	V
Reverse current @ rated V_R ⁽²⁾	$T_J = 25^\circ\text{C}$	I_R	-	2	μA
	$T_J = 125^\circ\text{C}$		5	-	μA
Junction capacitance	1MHz, $V_R = 4.0\text{V}$	C_J	31	-	pF
Reverse recovery time	$I_F = 0.5\text{A}, I_R = 1.0\text{A}, I_{rr} = 0.25\text{A}$	t_{rr}	-	25	ns
	$I_F = 1.0\text{A}, di/dt = 50\text{A}/\mu\text{s}, V_R = 30\text{V}$		26	-	
Reverse recovery current	$I_F = 3.0\text{A}, di/dt = 200\text{A}/\mu\text{s}, V_R = 400\text{V}$	I_{RM}	2.8	-	A
Reverse recovery charge		Q_{rr}	61	-	nC
Reverse recovery time		t_{rr}	43	-	ns

Notes:

1. Pulse test with PW = 0.3ms
2. Pulse test with PW = 30ms

ORDERING INFORMATION		
ORDERING CODE	PACKAGE	PACKING
PU3JB	DO-214AA (SMB)	3,000/ Tape & Reel

CHARACTERISTICS CURVES

($T_A = 25^\circ\text{C}$ unless otherwise noted)

Fig.1 Forward Current Derating Curve

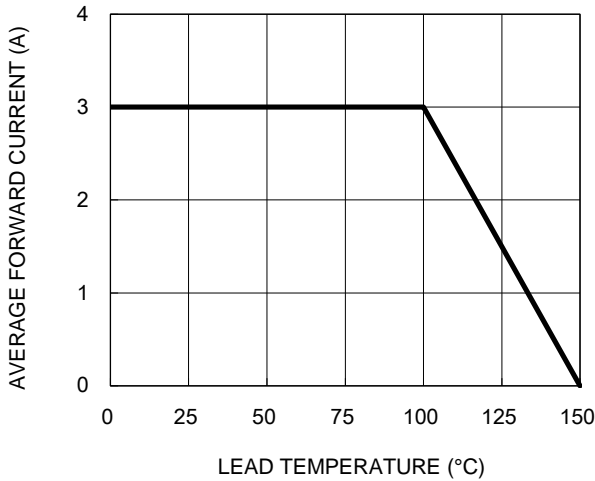

Fig.2 Typical Junction Capacitance

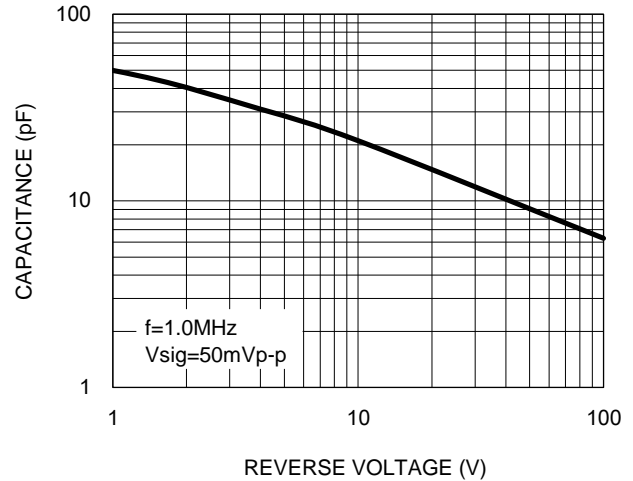

Fig.3 Typical Reverse Characteristics

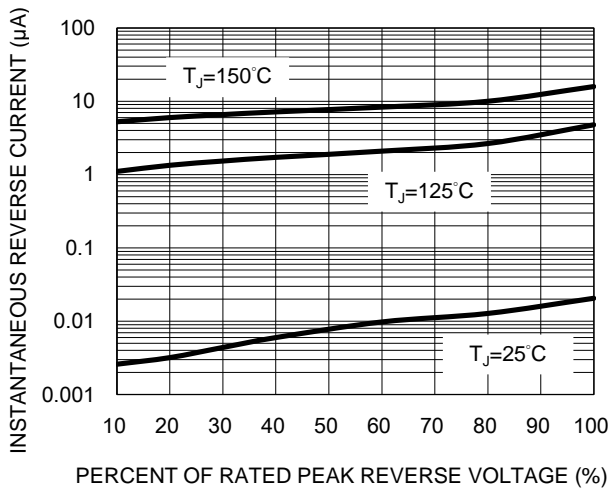

Fig.4 Typical Forward Characteristics

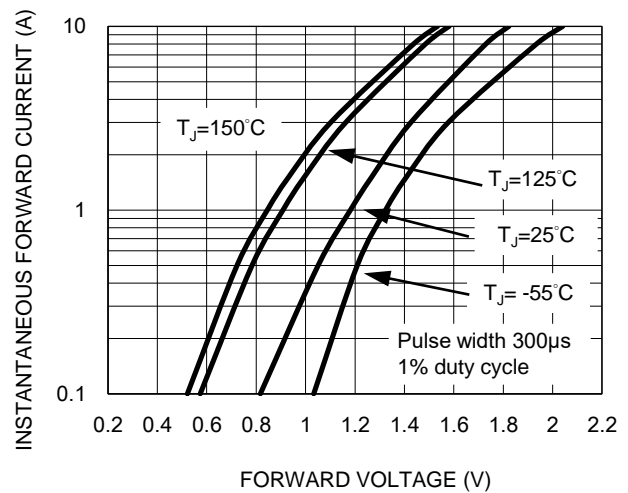
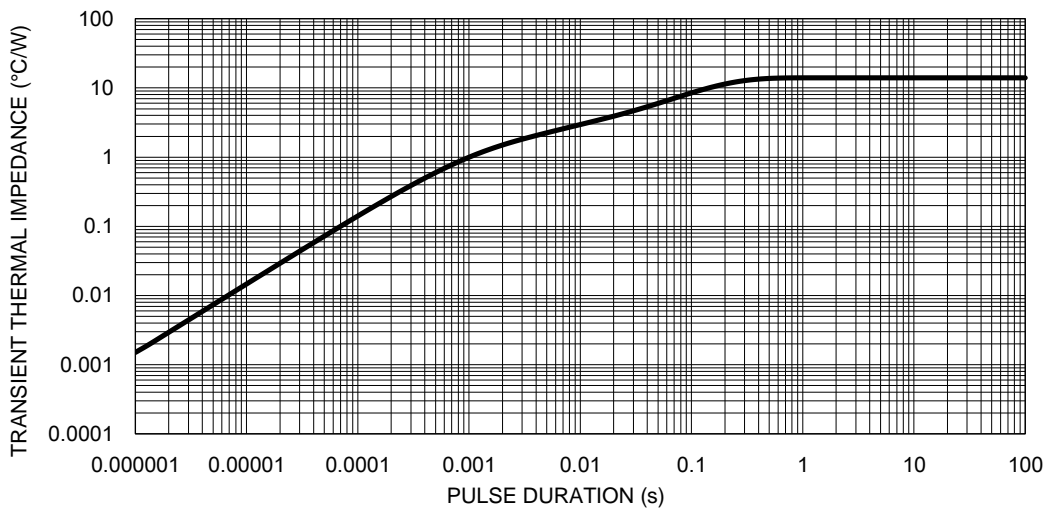
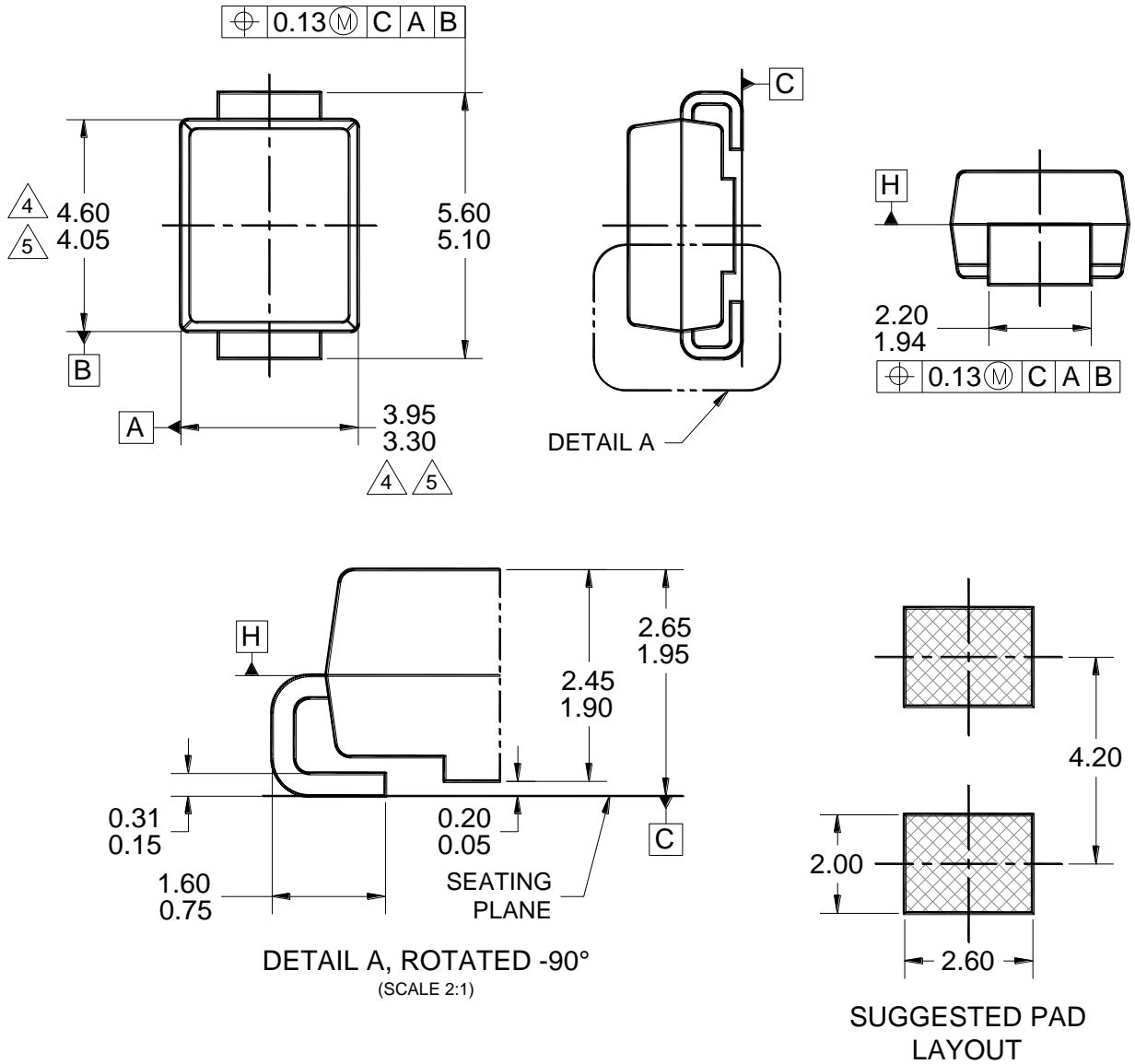

Fig.5 Typical Transient Thermal Impedance



PACKAGE OUTLINE DIMENSIONS

DO-214AA (SMB)



DETAIL A, ROTATED -90°
(SCALE 2:1)

SUGGESTED PAD LAYOUT

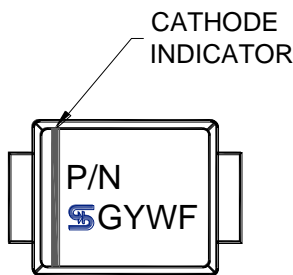

MARKING DIAGRAM

P/N = MARKING CODE
 G = GREEN COMPOUND
 YW = DATE CODE
 F = FACTORY CODE

NOTES: UNLESS OTHERWISE SPECIFIED

1. ALL DIMENSIONS ARE IN MILLIMETERS.
2. DIMENSIONING AND TOLERANCING PER ASME Y14.5M-1994.
3. PACKAGE OUTLINE REFERENCE: JEDEC DO-214, VARIATION AA, ISSUE D.
4. MOLDED PLASTIC BODY DIMENSIONS DO NOT INCLUDE MOLD FLASH.
5. MOLDED PLASTIC BODY LATERAL DIMENSIONS TO BE DETERMINED AT DATUM PLANE H.
6. DWG NO. REF: HQ2SD07-DO214SMB-035 REV A.

Notice

Specifications of the products displayed herein are subject to change without notice. TSC or anyone on its behalf, assumes no responsibility or liability for any errors or inaccuracies.

Purchasers are solely responsible for the choice, selection, and use of TSC products and TSC assumes no liability for application assistance or the design of Purchasers' products.

Information contained herein is intended to provide a product description only. No license, express or implied, to any intellectual property rights is granted by this document. Except as provided in TSC's terms and conditions of sale for such products, TSC assumes no liability whatsoever, and disclaims any express or implied warranty, relating to sale and/or use of TSC products including liability or warranties relating to fitness for a particular purpose, merchantability, or infringement of any patent, copyright, or other intellectual property right.

The products shown herein are not designed for use in medical, life-saving, or life-sustaining applications. Customers using or selling these products for use in such applications do so at their own risk and agree to fully indemnify TSC for any damages resulting from such improper use or sale.