

HEIDI-D

~10° diffused spot beam optimized for LUXEON Rebel ES

TECHNICAL SPECIFICATIONS:

Dimensions	Ø 21.6 mm
Height	11.7 mm
Fastening	tape, pin
Colour	clear
Box size	480 x 280 x 300 mm
Box weight	10.3 kg
Quantity in Box	3264 pcs
ROHS compliant	yes ⓘ



MATERIAL SPECIFICATIONS:

Component	Type	Material	Colour
HEIDI-D	Single lens	PMMA	clear
HEIDI-TAPE	Tape	PU tape	black

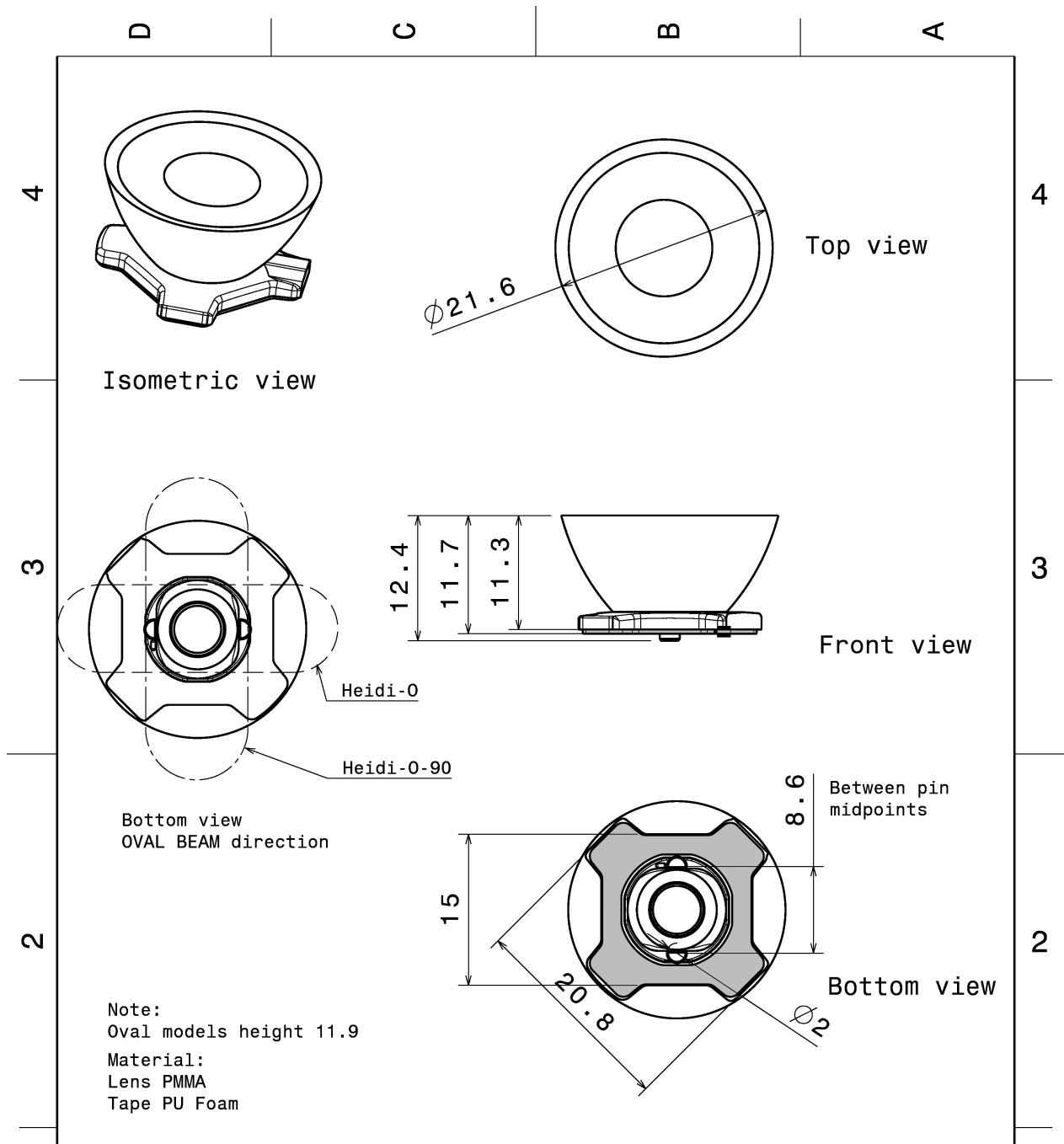

This drawing is our property. It can't be reproduced or communicated without our written agreement.		LEDiL		Ledil Oy Joensuunkatu 13 FIN-24100 SALO Finland	
DRAWING TITLE		Datasheet Heidi-Series Assy			
DRAWN BY ah	DATE 1.2.2012	SIZE A4	DRAWING NUMBER		REV 2
CHECKED BY	DATE	SCALE 2:1	WEIGHT (g)	SHEET 1/1	
DESIGNED BY	DATE				

PHOTOMETRIC DATA (MEASURED):

CREE 

LED XHP35 HD
FWHM 20.0°
Efficiency 83 %
Peak intensity 4.190 cd/lm
LEDs/each optic 1
Light colour White
Required components:

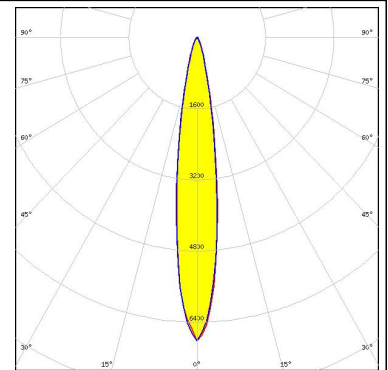

CREE 

LED XHP35 HI
FWHM 17.0°
Efficiency 94 %
Peak intensity 5.700 cd/lm
LEDs/each optic 1
Light colour White
Required components:

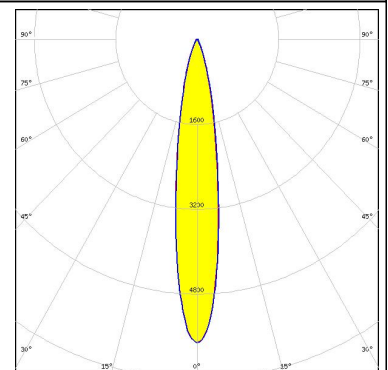
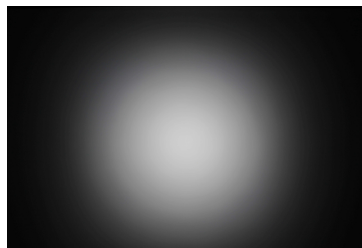

CREE 

LED XP-G2
FWHM 15.0°
Efficiency 94 %
Peak intensity 6.600 cd/lm
LEDs/each optic 1
Light colour White
Required components:

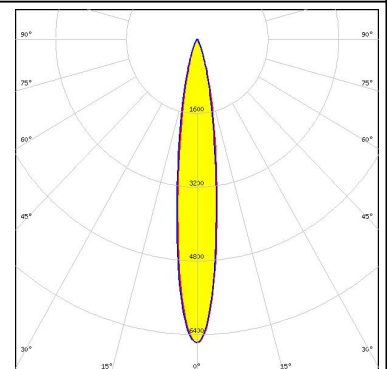
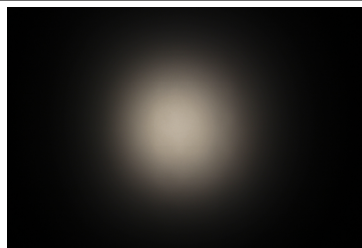

CREE 

LED XP-G3
FWHM 17.0°
Efficiency 94 %
Peak intensity 5.100 cd/lm
LEDs/each optic 1
Light colour White
Required components:

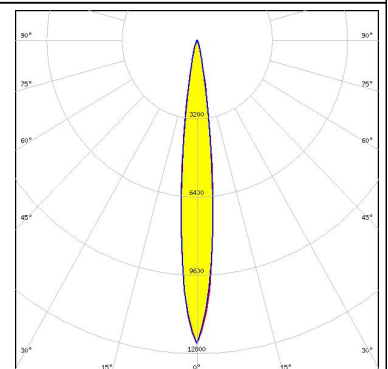

PHOTOMETRIC DATA (MEASURED):



LED XP-L HD
 FWHM 18.0°
 Efficiency 85 %
 Peak intensity 4.790 cd/lm
 LEDs/each optic 1
 Light colour White
 Required components:

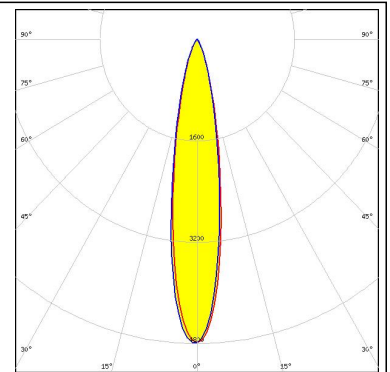
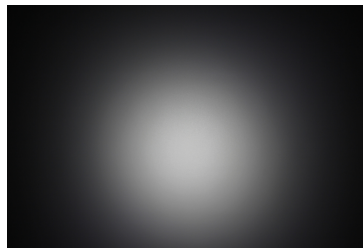

LED XT-E
 FWHM 14.0°
 Efficiency 94 %
 Peak intensity 7.900 cd/lm
 LEDs/each optic 1
 Light colour White
 Required components:

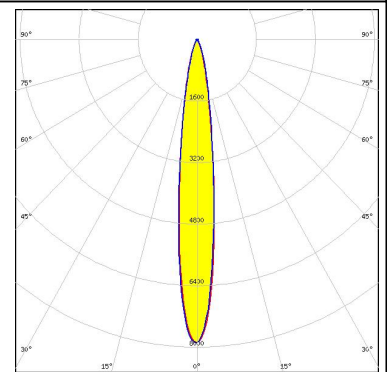
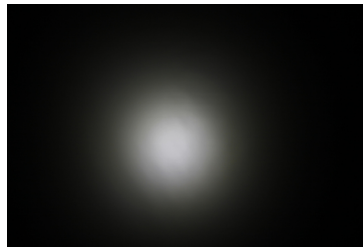

LED LUXEON A
 FWHM 12.0°
 Efficiency 86 %
 Peak intensity 10.000 cd/lm
 LEDs/each optic 1
 Light colour White
 Required components:

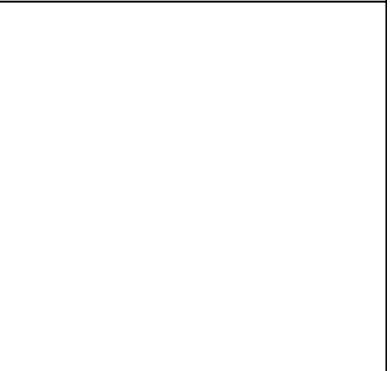

LED LUXEON Rebel
 FWHM 14.0°
 Efficiency 86 %
 Peak intensity 7.500 cd/lm
 LEDs/each optic 1
 Light colour White
 Required components:

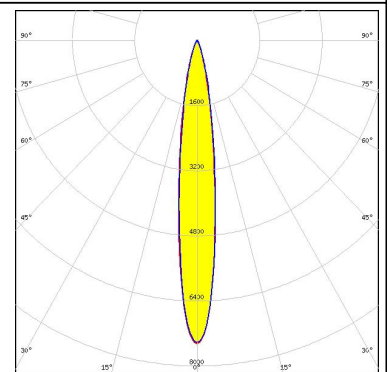

PHOTOMETRIC DATA (MEASURED):



LED LUXEON Rebel ES
 FWHM 15.0°
 Efficiency 91 %
 Peak intensity 6.500 cd/lm
 LEDs/each optic 1
 Light colour White
 Required components:

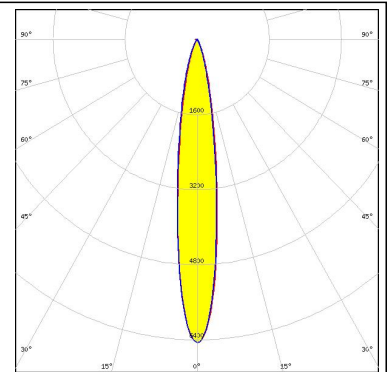
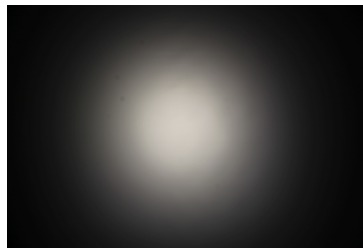

LED NVSW219D
 FWHM 16.0°
 Efficiency 94 %
 Peak intensity 5.800 cd/lm
 LEDs/each optic 1
 Light colour White
 Required components:

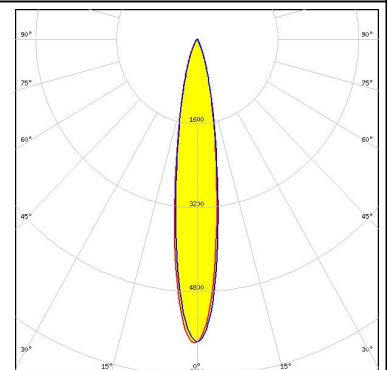
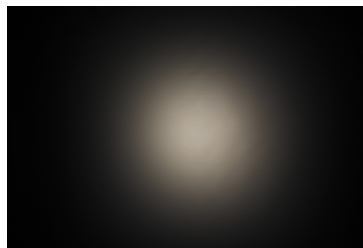

LED NVSW319B
 FWHM 18.0°
 Efficiency 93 %
 Peak intensity 5.200 cd/lm
 LEDs/each optic 1
 Light colour White
 Required components:

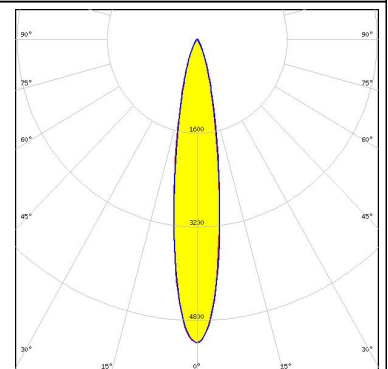
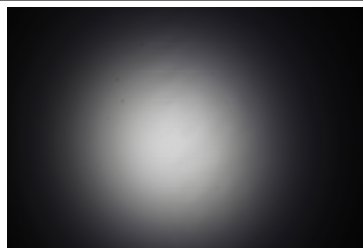

LED NVSW3x9A
 FWHM 18.0°
 Efficiency 90 %
 Peak intensity 4.800 cd/lm
 LEDs/each optic 1
 Light colour White
 Required components:

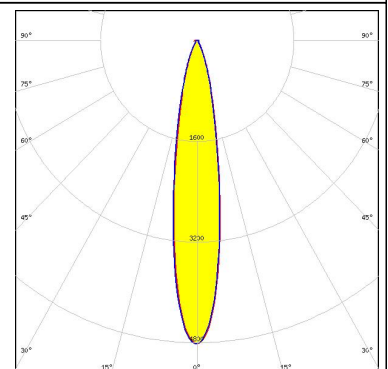
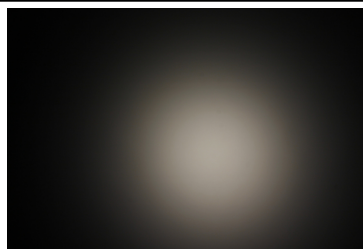

PHOTOMETRIC DATA (MEASURED):



LED NWSx229A
FWHM 20.0°
Efficiency 84 %
Peak intensity 4.100 cd/lm
LEDs/each optic 1
Light colour White
Required components:

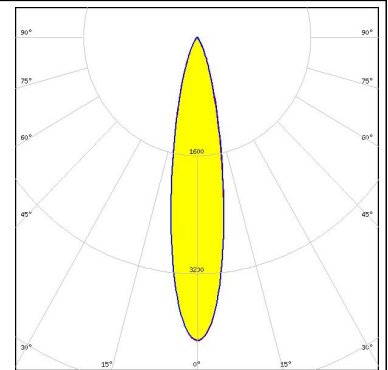

LED OSOLON SSL 150
FWHM 13.0°
Efficiency 87 %
Peak intensity 9.100 cd/lm
LEDs/each optic 1
Light colour White
Required components:

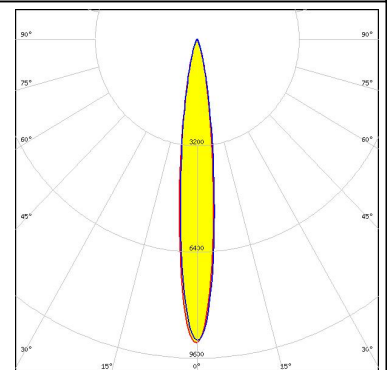

SEOL SEMICONDUCTOR

LED Z5M3
FWHM 17.0°
Efficiency 94 %
Peak intensity 5.200 cd/lm
LEDs/each optic 1
Light colour White
Required components:

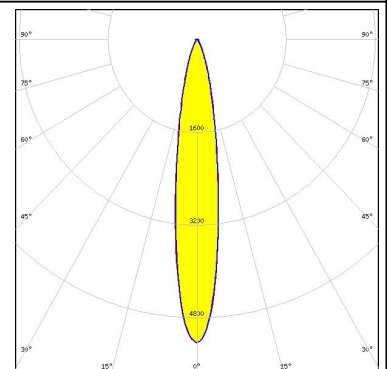
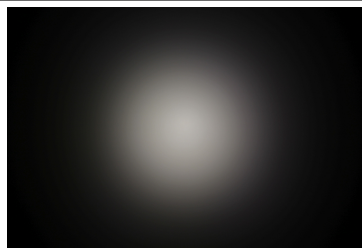

SEOL SEMICONDUCTOR

LED Z8Y22P
FWHM 17.0°
Efficiency 92 %
Peak intensity 5.000 cd/lm
LEDs/each optic 1
Light colour White
Required components:

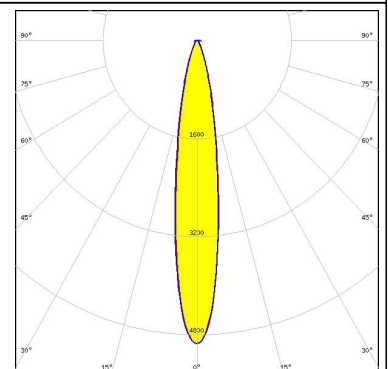
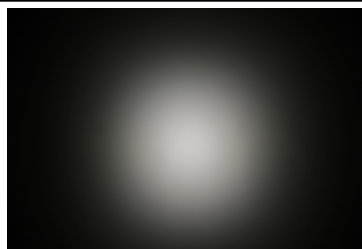

PHOTOMETRIC DATA (SIMULATED):



LED XP-G2 HE
 FWHM 14.0°
 Efficiency 95 %
 Peak intensity 10.657 cd/lm
 LEDs/each optic 1
 Light colour White
 Required components:

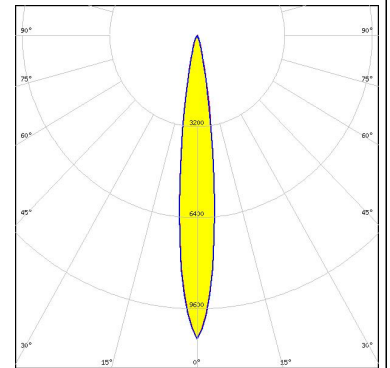

LED LUXEON R
 FWHM 12.0°
 Efficiency %
 Peak intensity cd/lm
 LEDs/each optic 1
 Light colour White
 Required components:



LED LUXEON SunPlus 20 Line (120 deg)
 FWHM 9.0°
 Efficiency 96 %
 Peak intensity 26.133 cd/lm
 LEDs/each optic 1
 Light colour White
 Required components:

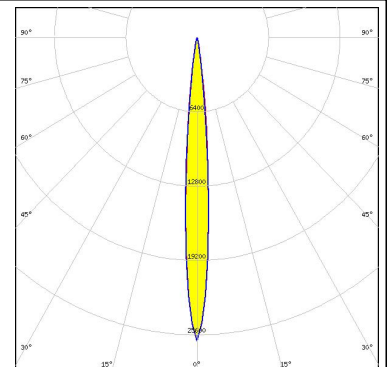

LED LUXEON SunPlus 20 Line (150 deg)
 FWHM 8.7°
 Efficiency 93 %
 Peak intensity 25.630 cd/lm
 LEDs/each optic 1
 Light colour White
 Required components:

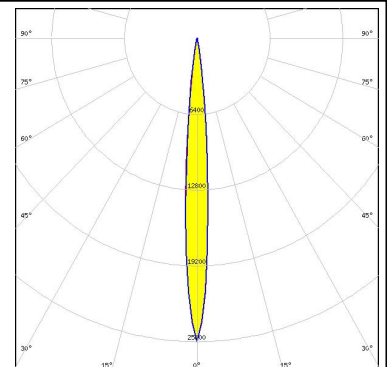

PHOTOMETRIC DATA (SIMULATED):

LUMILEDS

LED LUXEON SunPlus 20 Line (150 deg)
 FWHM 8.0°
 Efficiency 92 %
 Peak intensity 24.852 cd/lm
 LEDs/each optic 1
 Light colour White
 Required components:

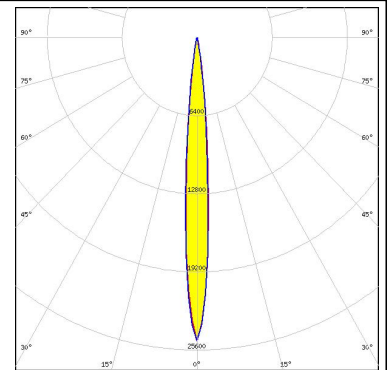

LUMILEDS

LED LUXEON SunPlus 35 Line
 FWHM 8.5°
 Efficiency 94 %
 Peak intensity 27.150 cd/lm
 LEDs/each optic 1
 Light colour White
 Required components:

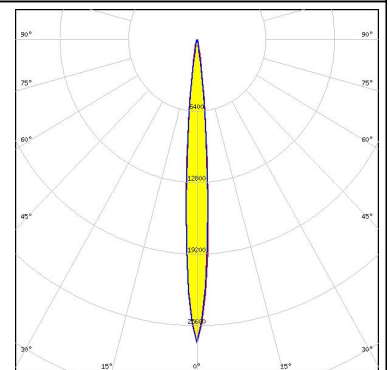

LUMILEDS

LED LUXEON Z ES
 FWHM 10.0°
 Efficiency 94 %
 Peak intensity 20.500 cd/lm
 LEDs/each optic 1
 Light colour White
 Required components:

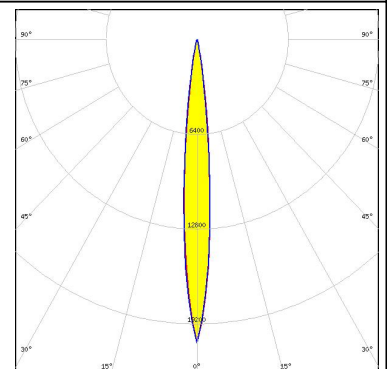

NICHIA

LED NCSxE17A
 FWHM 10.0°
 Efficiency 92 %
 Peak intensity 18.209 cd/lm
 LEDs/each optic 1
 Light colour White
 Required components:

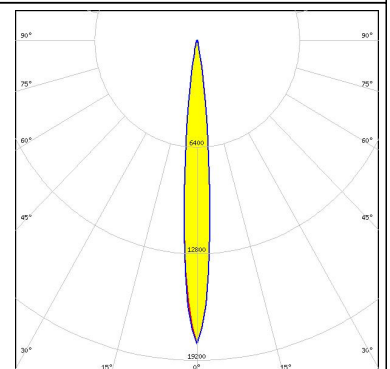

PHOTOMETRIC DATA (SIMULATED):



LED NVSxE21A
FWHM 10.0°
Efficiency 94 %
Peak intensity 17.499 cd/lm
LEDs/each optic 1
Light colour White
Required components:

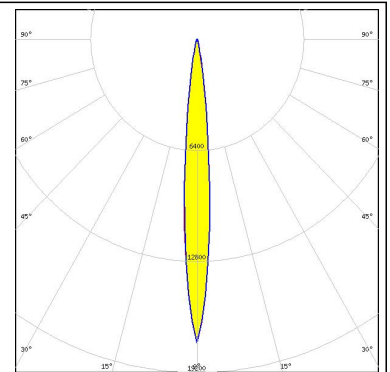

Opto Semiconductors

LED OSCONIQ P 3737 Flat
FWHM 11.0°
Efficiency 97 %
Peak intensity 15.283 cd/lm
LEDs/each optic 1
Light colour White
Required components:

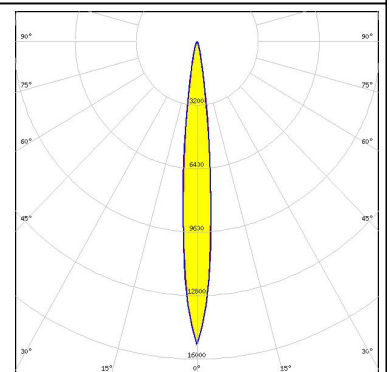

GENERAL INFORMATION:

NOTE: The typical beam angle will be changed by different color, chip size and chip position tolerance. The typical total beam angle is the full angle measured where the luminous intensity is half of the peak value.

MATERIALS:

As part of our continuous research and improvement processes, and to ensure the best possible quality and availability of our products, LEDiL reserves the right to change material grades without notice.

PRODUCT DATA USER AGREEMENT AND DISCLAIMER:

The measured data in the provided downloadable LEDiL Product Datasheets and Mechanical 2D-Drawings is rounded and provided as reference for planning. LEDiL Oy's optical specifications have been verified by conducting performance testing of the products in accordance with the company's quality system. The reported data are averaged results of multiple measurements with typical variation. LEDiL Oy reserves the right to without prior notification make changes and improvements to its products.

LEDiL Oy assumes neither warranty, nor guarantee nor any other liability of any kind for the contents and correctness of the provided data. The provided data has been generated with highest diligence but the provided data may in reality not represent the complete possible variation range of all intrinsic parameters. Therefore, in certain cases a deviation from the provided data could occur.

LEDiL Oy reserves the right to undertake technical changes of its products without further notification which could lead to changes in the provided data. LEDiL Oy assumes no liability of any kind for the possible deviation from any provided data or any other damage resulting from the usage of the provided data.

The user agrees to this disclaimer and user agreement with the download or usage of the provided files.

LEDiL Oy

Joensuunkatu 13
FI-24240 SALO
Finland

LEDiL Inc.

228 West Page Street
Suite D
Sycamore IL 60178
USA

Local sales and technical support

[www.ledil.com/
where_to_buy](http://www.ledil.com/where_to_buy)

Shipping locations

Salo, Finland
Hong Kong, China

Distribution Partners

[www.ledil.com/
where_to_buy](http://www.ledil.com/where_to_buy)