



Datasheet

9-in-1 GuardianX

Part No:
MA9929.A.001

Description:

Guardian X 9-in-1 Combination Adhesive Mount Antenna
1*Active GNSS, 4*5G/4G MIMO 4*Dual-Band Wi-Fi MIMO

Features:

Low-profile IP67 Rated Housing

4*5G/4G MIMO 600-6000MHz

4*Wi-Fi MIMO 2.4/5.8GHz

1*GNSS - GPS-GLONASS

Cables: GNSS 5m of RG-174, 5G/4G and Wi-Fi m of TGC-200

Connectors: GNSS FAKRA Code C, 5G/4G – FAKRA Code D, Wi-Fi – FAKRA Code I

Dimensions: 360x160x20.5mm

CE Certified

RoHS & Reach Compliant



| | |
|-----------------------------------|----|
| 1. Introduction | 3 |
| 2. Specifications | 4 |
| 3. Antenna Characteristics | 10 |
| 4. Active Antenna Characteristics | 24 |
| 5. Radiation Patterns | 26 |
| 6. Mechanical Drawing | 79 |
| 7. Packaging | 80 |
| <hr/> | |
| Changelog | 81 |

Taoglas makes no warranties based on the accuracy or completeness of the contents of this document and reserves the right to make changes to specifications and product descriptions at any time without notice. Taoglas reserves all rights to this document and the information contained herein. Reproduction, use or disclosure to third parties without express permission is strictly prohibited.



1. Introduction

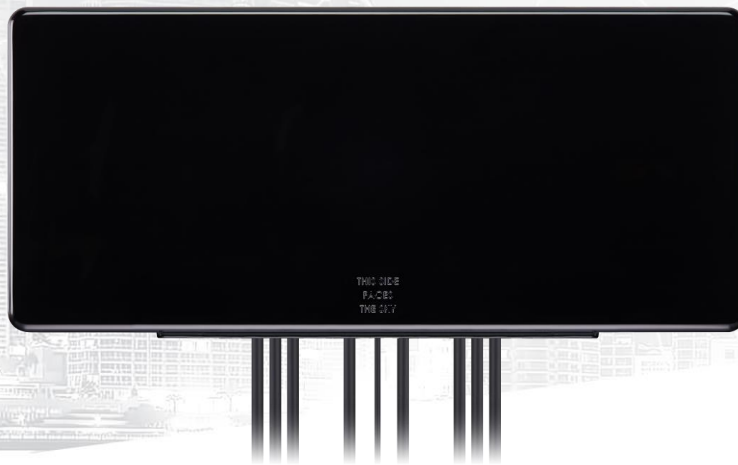

The Taoglas MA9929 Guardian X has been designed to combine a high number of antenna combinations in one enclosure. The MA9929 is a 9-in-1 combination antenna that combines all 9 antenna elements in one low-profile heavy-duty, IP67 rated waterproof, adhesive mount external enclosure. The MA9929 comes with 1* Active GPS/GLONASS/Galileo, 4* 5G/4G Cellular MIMO (600-6000MHz), 4* Wi-Fi 6 MIMO (2.4/5.1-7.125GHz) as standard. The MA9929 has been designed as a low profile solution for IoT and Automotive applications where space is at a premium.

This is an ideal external combination antenna solution that is used where drilling a hole through the roof of a vehicle or a metal panel for an external antenna is not feasible.

The MA9929 also operates at Band 71, the newly established 5G band at 600MHz.

Typical applications include:

- Passenger Bus / Rail / Air Applications.
- Automotive and Heavy Equipment Vehicle Tracking and Telematics
- HD Video over 5G/4G
- First Responder and Emergency Services
- M2M Applications/IoT

5G/4G applications demand high-speed data uplink and downlink. High efficiency and high gain MIMO antennas are necessary to achieve the required signal to noise ratio and throughput required to solve these challenges. Taoglas also takes care to ensure high isolation between the MIMO antennas to prevent self-interference. Low loss cables are used to keep efficiency high over longer cable lengths. In contrast, smaller MIMO antennas with poorer quality thin cables will have reduced efficiency and isolation, which would lead to a large drop in system throughput, increased incidences of signal drops, and may indeed not make a system connection at all.

Cable type and length, and connector types are fully customizable and the GuardianX can also be customized for any variation of antennas below 9-in-1. Contact your regional Taoglas customer support team for more information.

2. Specifications

| GNSS Frequency Bands Covered | | | | | | | |
|------------------------------|----------|------------|-----|----|----|--|--|
| GPS | L1 | L2 | L5 | | | | |
| | ■ | □ | □ | | | | |
| GLONASS | G1 | G2 | G3 | | | | |
| | ■ | □ | □ | | | | |
| Galileo | E1 | E5a | E5b | E6 | | | |
| | ■ | □ | □ | □ | | | |
| BeiDou | B1 | B2a | B2b | B3 | | | |
| | □ | □ | □ | □ | | | |
| QZSS (Regional) | L1 | L2C | L5 | L6 | | | |
| | ■ | □ | □ | □ | | | |
| IRNSS (Regional) | L5 | | | | | | |
| | □ | | | | | | |
| SBAS | L1/E1/B1 | L5/B2a/E5a | G1 | G2 | G3 | | |
| | ■ | □ | ■ | □ | □ | | |

*SBAS systems: WASS(L1/L5), EGNOS(E1/E5a), SDCM(G1/G2/G3), SNAS(B1,B2a), GAGAN(L1/L5), QZSS(L1/L5), KAZZ(L1/L5).

| GNSS Electrical | | |
|------------------|---------|-------|
| Frequency (MHz) | 1575.42 | 1602 |
| VSWR (max.) | 2.0:1 | 2.0:1 |
| Efficiency (%) | 67 | 71 |
| Peak Gain | 3 | 3.2 |
| Axial Ratio (dB) | 6 | 14 |
| Polarization | RHCP | |
| Impedance | 50Ω | |

| LNA and Filter Electrical Properties | | |
|--|----------------|-------------|
| Frequency (MHz) | 1575.42 | 1602 |
| VSWR (max.) | 2.0:1 | 2.0:1 |
| Gain@1.8V (Typ.) | 25 | 25 |
| Gain@3.0V (Typ.) | 31 | 31 |
| Gain@5.5V (Typ.) | 34 | 34 |
| Noise@1.8V (Typ.) | 3 | 3 |
| Noise@3.0V (Typ.) | 3 | 3 |
| Noise@5.5V (Typ.) | 3.3 | 3.3 |
| Power consumption@1.8V (Typ.) | 5 | |
| Power consumption@3.0V (Typ.) | 10 | |
| Power consumption@5.5V (Typ.) | 23 | |
| Total Specification (Through Antenna, SAW Filter and LNA) | | |
| Frequency (MHz) | 1575.42 | 1602 |
| Gain@3V (dBi) | 31 ± 3 | 30 ± 3 |
| Output Impedance | 50 Ω | |

| 5G/4G MIMO Antennas | | | | | | | | | | | |
|---------------------|------------|---------|------------|-----------|-----------|-----------|-----------|-----------|-----------|-----------|--------|
| Frequency (MHz) | 5G Band 71 | LTE700 | GSM800 900 | 5G NR 74 | 5GNR N66 | LTE2600 | 5GNR N77 | 5GNR N78 | 5GNR N79 | LTE5200 | |
| | 617-698 | 698-824 | 824-960 | 1427-1518 | 1710-2200 | 2300-2690 | 3300-4200 | 3300-3800 | 4400-5000 | 5150-5925 | |
| Efficiency (%) | | | | | | | | | | | |
| LTE1 | 5.0m | 36.0 | 40.1 | 34.1 | 38.3 | 33.2 | 29.2 | 21.3 | 21.0 | 23.2 | 16.0 |
| LTE2 | 5.0m | 22.7 | 25.9 | 26.7 | 12.2 | 25.5 | 21.7 | 18.4 | 18.8 | 11.6 | 9.0 |
| LTE3 | 5.0m | 24.4 | 26.1 | 26.4 | 27.4 | 25.5 | 25.0 | 20.5 | 20.8 | 17.1 | 9.3 |
| LTE4 | 5.0m | 13.5 | 25.9 | 26.6 | 30.4 | 25.3 | 23.9 | 18.1 | 18.4 | 12.1 | 9.4 |
| Average Gain (dB) | | | | | | | | | | | |
| LTE1 | 5.0m | -4.43 | -3.96 | -4.67 | -4.17 | -4.79 | -5.34 | -6.72 | -6.78 | -6.35 | -7.97 |
| LTE2 | 5.0m | -6.43 | -5.86 | -5.74 | -9.13 | -5.93 | -6.63 | -7.35 | -7.26 | -9.37 | -10.45 |
| LTE3 | 5.0m | -6.13 | -5.83 | -5.78 | -5.63 | -5.94 | -6.02 | -6.88 | -6.83 | -7.68 | -10.30 |
| LTE4 | 5.0m | -8.69 | -5.87 | -5.75 | -5.17 | -5.97 | -6.22 | -7.43 | -7.34 | -9.16 | -10.27 |
| Peak Gain (dBi) | | | | | | | | | | | |
| LTE1 | 5.0m | 2.22 | 2.24 | -0.11 | 3.18 | 2.71 | 1.89 | 0.67 | 0.67 | 0.52 | -0.02 |
| LTE2 | 5.0m | 0.09 | 0.17 | 1.46 | -2.68 | 0.56 | -0.02 | -0.03 | -0.03 | -1.70 | -3.23 |
| LTE3 | 5.0m | 1.64 | 1.65 | 1.41 | 0.39 | 1.89 | 1.96 | 0.86 | 0.86 | -1.14 | -1.99 |
| LTE4 | 5.0m | -1.52 | 0.07 | 0.02 | 1.69 | 1.46 | 1.86 | 0.96 | 0.96 | -1.68 | -2.66 |
| Impedance | 50 Ω | | | | | | | | | | |
| Polarization | Linear | | | | | | | | | | |
| Radiation Pattern | Omni | | | | | | | | | | |
| Max. input power | 20W | | | | | | | | | | |

| Wi-Fi MIMO | | | | | | | |
|--------------------------|------|-----------|-----------|-----------|-----------|-----------|-----------|
| Frequency (MHz) | | 2.4GHz | 5GHz | 6.175GHz | 6.475GHz | 6.7GHz | 7GHz |
| | | 2400-2500 | 5150-5850 | 5925-6425 | 6425-6525 | 6525-6875 | 6875-7125 |
| Efficiency (%) | | | | | | | |
| WiFi1 | 5.0m | 25.0 | 19.8 | 16.3 | 15.2 | 15.2 | 13.3 |
| WiFi2 | 5.0m | 23.8 | 19.9 | 17.2 | 14.9 | 14.5 | 12.7 |
| WiFi3 | 5.0m | 21.8 | 23.7 | 17.7 | 15.9 | 15.4 | 14.8 |
| WiFi4 | 5.0m | 28.5 | 24.2 | 17.8 | 14.6 | 14.4 | 13.3 |
| Average Gain (dB) | | | | | | | |
| WiFi1 | 5.0m | -6.02 | -7.02 | -7.87 | -8.18 | -8.20 | -8.78 |
| WiFi2 | 5.0m | -6.23 | -7.02 | -7.64 | -8.26 | -8.39 | -8.95 |
| WiFi3 | 5.0m | -6.62 | -6.26 | -7.53 | -7.98 | -8.14 | -8.29 |
| WiFi4 | 5.0m | -5.45 | -6.16 | -7.50 | -8.34 | -8.41 | -8.77 |
| Peak Gain (dBi) | | | | | | | |
| WiFi1 | 5.0m | -0.28 | 0.10 | -0.96 | -2.45 | -1.78 | -2.85 |
| WiFi2 | 5.0m | 0.21 | -0.51 | -1.03 | -1.91 | -1.65 | -2.83 |
| WiFi3 | 5.0m | 0.37 | 2.29 | -0.24 | -0.24 | -1.52 | -1.99 |
| WiFi4 | 5.0m | 2.72 | 2.45 | -0.77 | -2.37 | -1.78 | -1.42 |

| Mechanical | |
|-------------------------------|--|
| Height without Bracket | 20.5mm |
| Planner Dimension | 360x160mm |
| Bracket Dimensions | ∅77x6.3mm |
| Housing Material | PC |
| Adhesive | CR4305 + 3M 9448HK |
| Cable | 5m TGC200 for 5G/4G – Fully Customizable 5m TGC200 for Wi-Fi – Fully Customizable 5m RG174 for GNSS – Fully Customizable |
| Connector | 5G/4G: FAKRA Code D Bordeaux Violet – Fully Customizable Wi-Fi: FAKRA Code I Beige – Fully Customizable GNSS: FAKRA Code C Blue – Fully Customizable |
| Weight | 1068 g |
| Environmental | |
| Protection | IP67 |
| Temperature Range | -40°C to 85°C |
| Humidity | Non-condensing 65°C 95% RH |

| 5G/4G Bands | | | |
|-------------|---|----------------------|---------|
| Band Number | 5GNR / FR1 / LTE / LTE-Advanced / WCDMA / HSPA / HSPA+ / TD-SCDMA | | |
| | Uplink | Downlink | Covered |
| 1 | UL: 1920 to 1980 | DL: 2110 to 2170 | ✓ |
| 2 | UL: 1850 to 1910 | DL: 1930 to 1990 | ✓ |
| 3 | UL: 1710 to 1785 | DL: 1805 to 1880 | ✓ |
| 4 | UL: 1710 to 1755 | DL: 2110 to 2155 | ✓ |
| 5 | UL: 824 to 849 | DL: 869 to 894 | ✓ |
| 7 | UL: 2500 to 2570 | DL: 2620 to 2690 | ✓ |
| 8 | UL: 880 to 915 | DL: 925 to 960 | ✓ |
| 9 | UL: 1749.9 to 1784.9 | DL: 1844.9 to 1879.9 | ✓ |
| 11 | UL: 1427.9 to 1447.9 | DL: 1475.9 to 1495.9 | ✓ |
| 12 | UL: 699 to 716 | DL: 729 to 746 | ✓ |
| 13 | UL: 777 to 787 | DL: 746 to 756 | ✓ |
| 14 | UL: 788 to 798 | DL: 758 to 768 | ✓ |
| 17 | UL: 704 to 716 | DL: 734 to 746 | ✓ |
| 18 | UL: 815 to 830 | DL: 860 to 875 | ✓ |
| 19 | UL: 830 to 845 | DL: 875 to 890 | ✓ |
| 20 | UL: 832 to 862 | DL: 791 to 821 | ✓ |
| 21 | UL: 1447.9 to 1462.9 | DL: 1495.9 to 1510.9 | ✓ |
| 22 | UL: 3410 to 3490 | DL: 3510 to 3590 | ✓ |
| 23 | UL: 2000 to 2020 | DL: 2180 to 2200 | ✓ |
| 24 | UL: 1625.5 to 1660.5 | DL: 1525 to 1559 | ✓ |
| 25 | UL: 1850 to 1915 | DL: 1930 to 1995 | ✓ |
| 26 | UL: 814 to 849 | DL: 859 to 894 | ✓ |
| 27 | UL: 807 to 824 | DL: 852 to 869 | ✓ |
| 28 | UL: 703 to 748 | DL: 758 to 803 | ✓ |
| 29 | UL: - | DL: 717 to 728 | ✓ |
| 30 | UL: 2305 to 2315 | DL: 2350 to 2360 | ✓ |
| 31 | UL: 452.5 to 457.5 | DL: 462.5 to 467.5 | ✗ |
| 32 | UL: - | DL: 1452 - 1496 | ✓ |
| 35 | | 1850 to 1910 | ✓ |
| 38 | | 2570 to 2620 | ✓ |
| 39 | | 1880 to 1920 | ✓ |
| 40 | | 2300 to 2400 | ✓ |
| 41 | | 2496 to 2690 | ✓ |
| 42 | | 3400 to 3600 | ✓ |
| 43 | | 3600 to 3800 | ✓ |
| 48 | | 3550 to 3700 | ✓ |
| 66 | UL: 1710-1780 | DL: 2110-2200 | ✓ |
| 71 | | 617 to 698 | ✓ |
| 74/75/76 | | 1427 to 1518 | ✓ |
| 78 | | 3300 to 3800 | ✓ |
| 79 | | 4400 to 5000 | ✓ |

3. Antenna Characteristics

3.1 Return Loss - GNSS

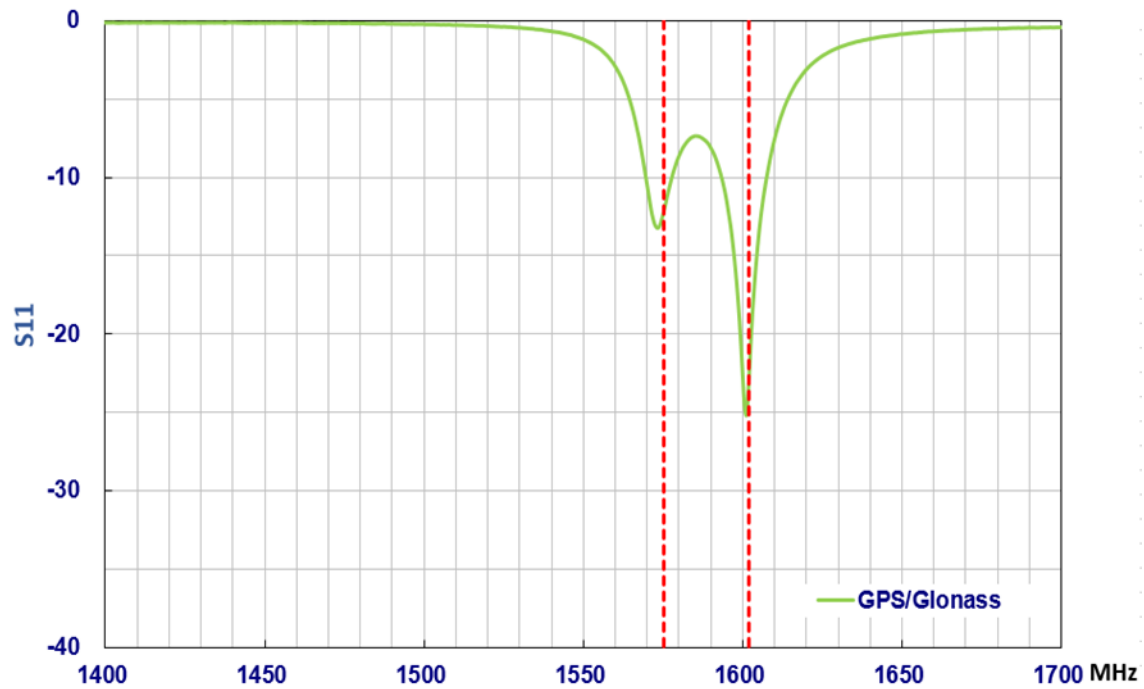

3.2 Efficiency - GNSS

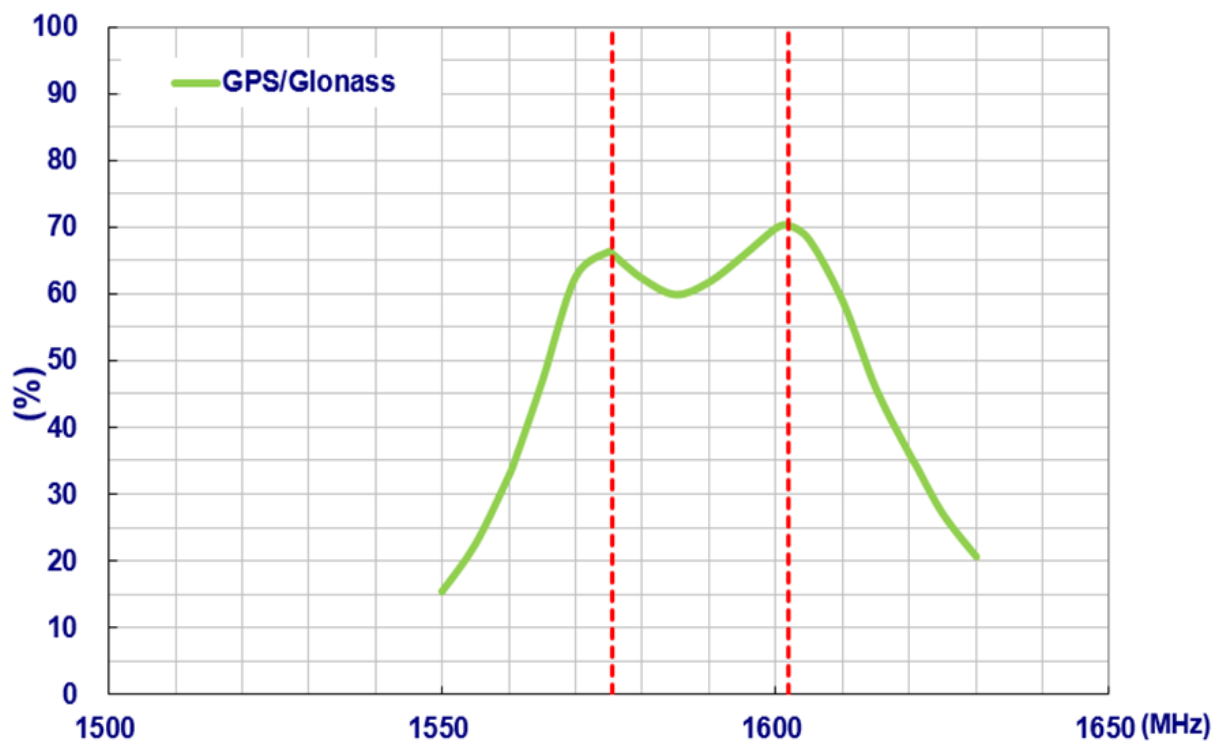

3.3 Average Gain - GNSS

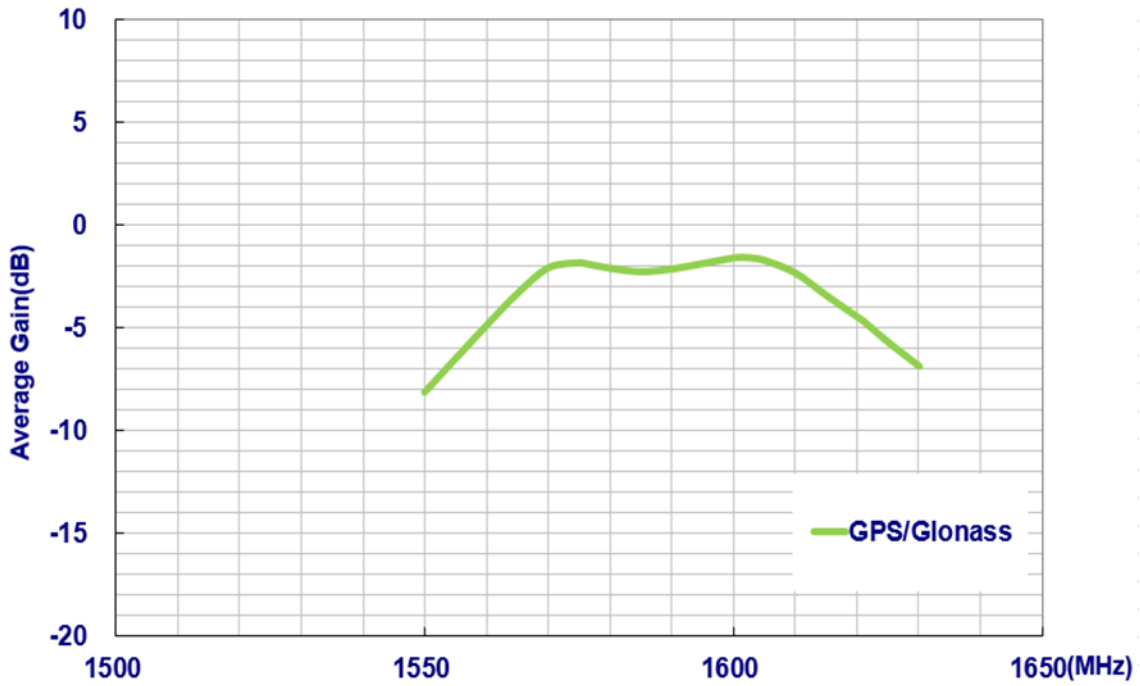

3.4 Peak Gain - GNSS

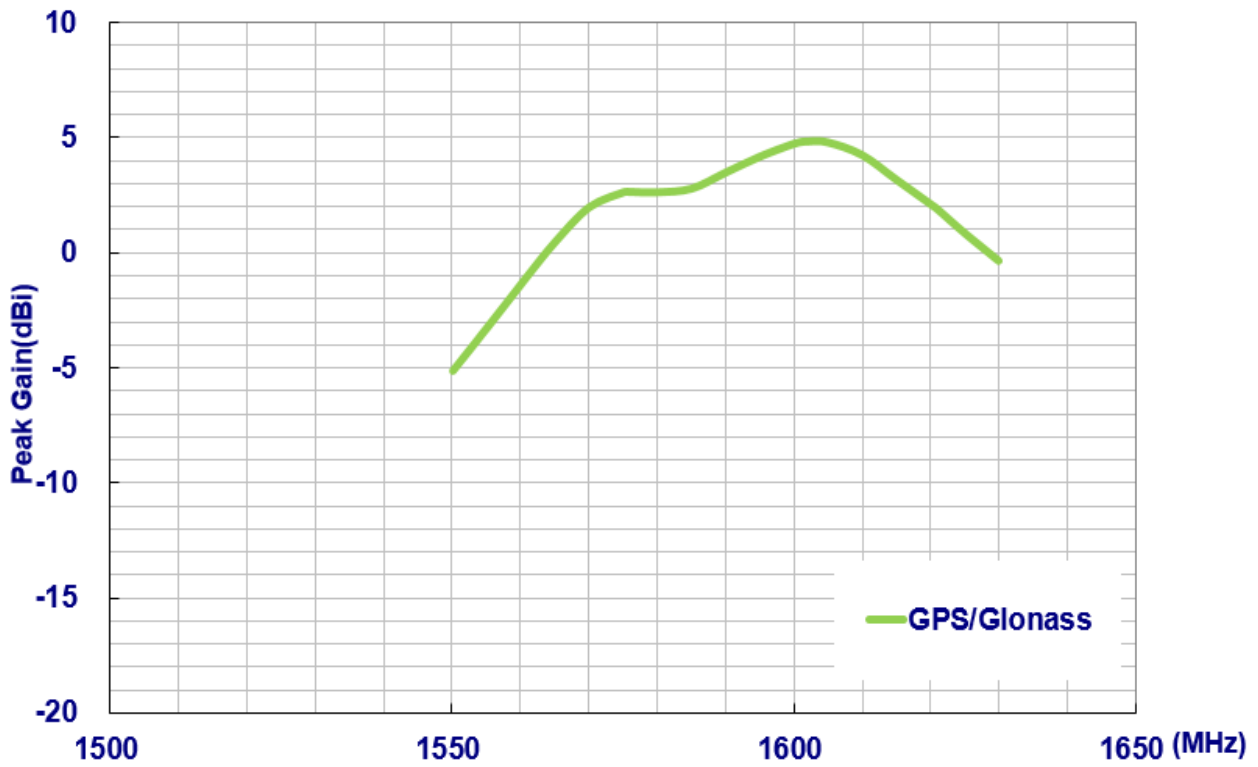

3.5 Efficiency – 5G/4G MIMO 1

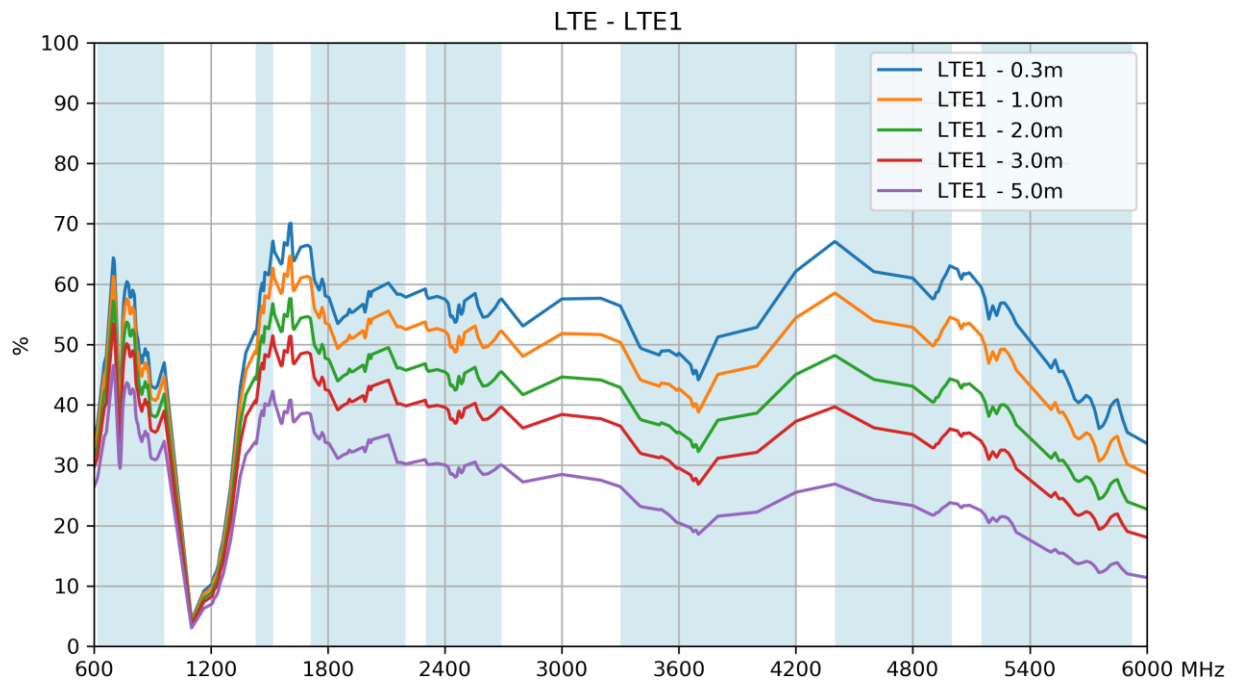

3.6 Efficiency – 5G/4G MIMO 2

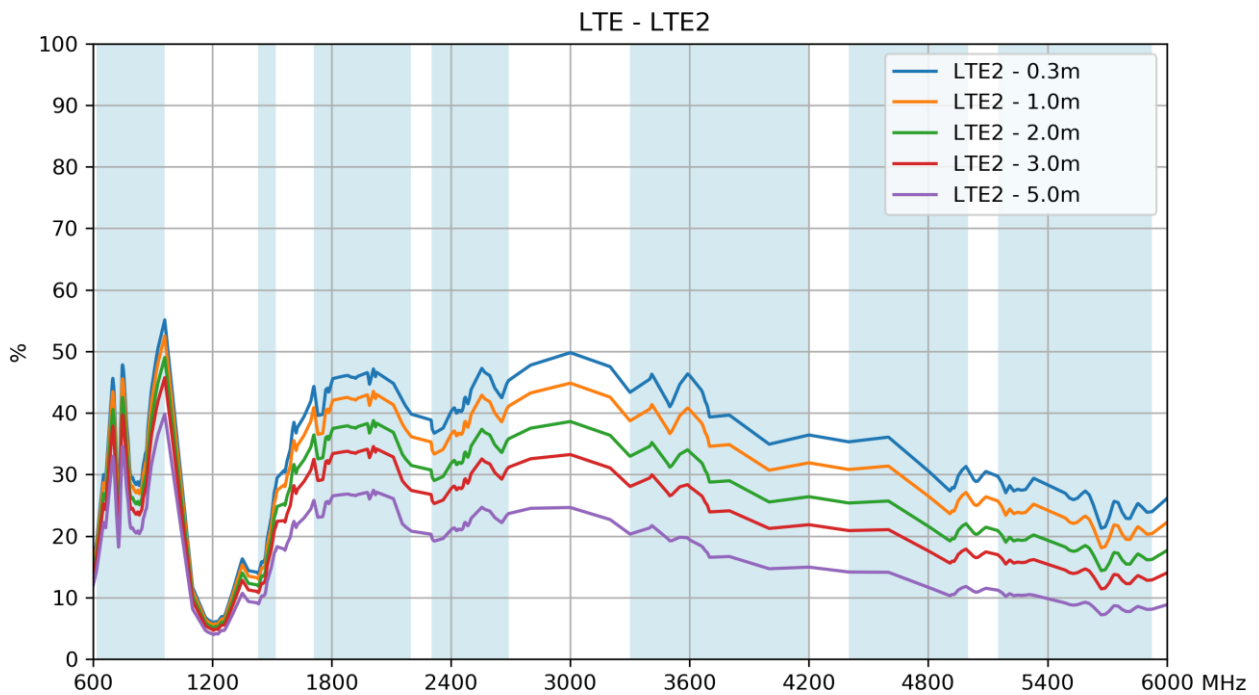

3.7 Efficiency – 5G/4G MIMO 3

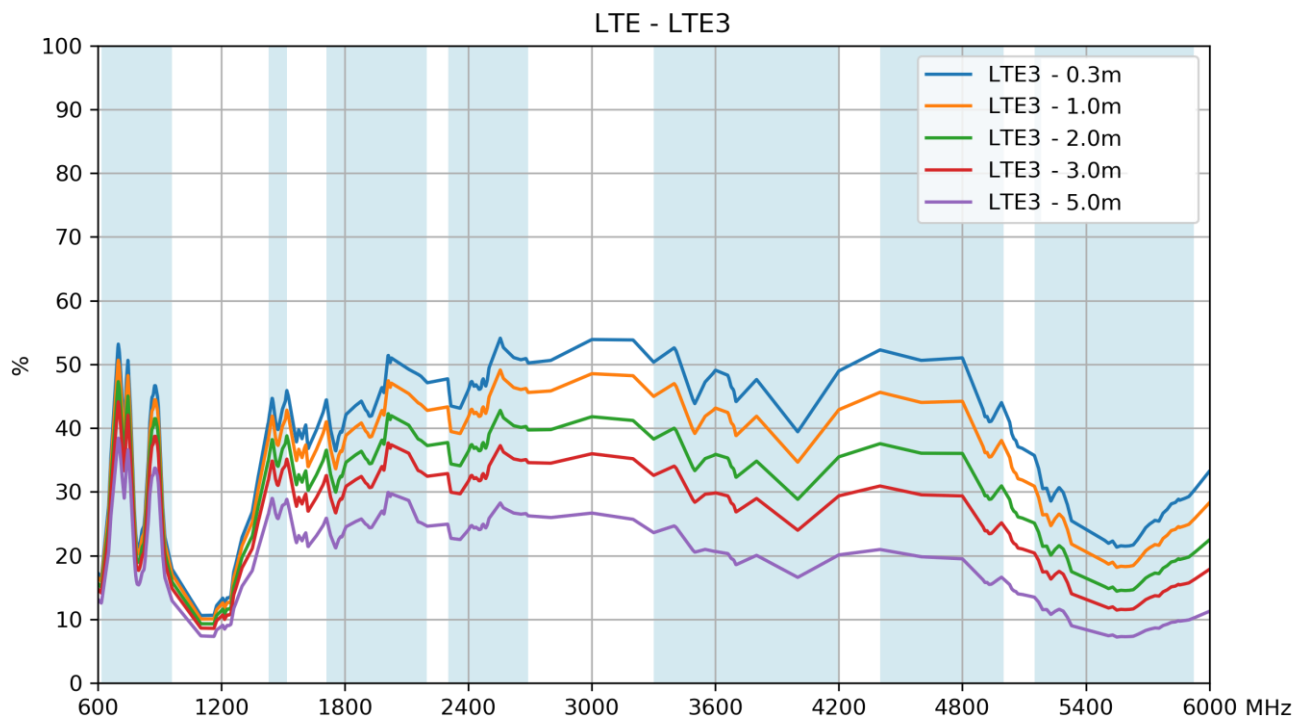

3.8 Efficiency – 5G/4G MIMO 4

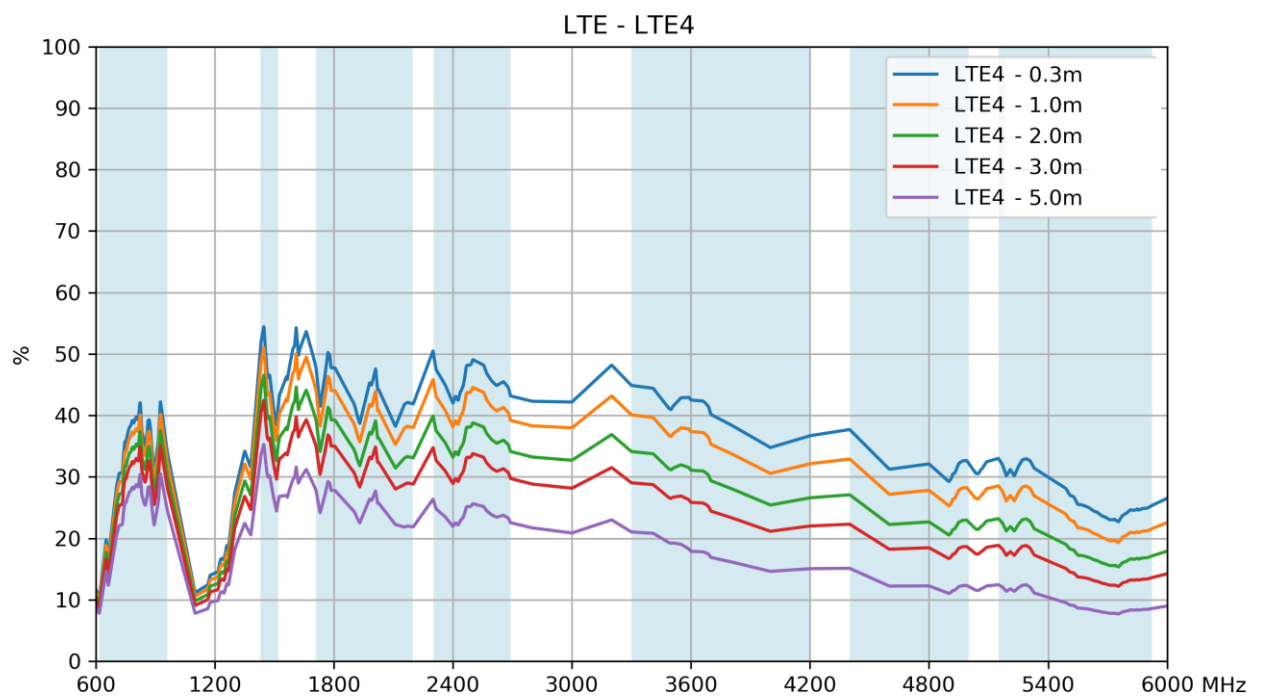

3.9 Efficiency – Wi-Fi MIMO 1

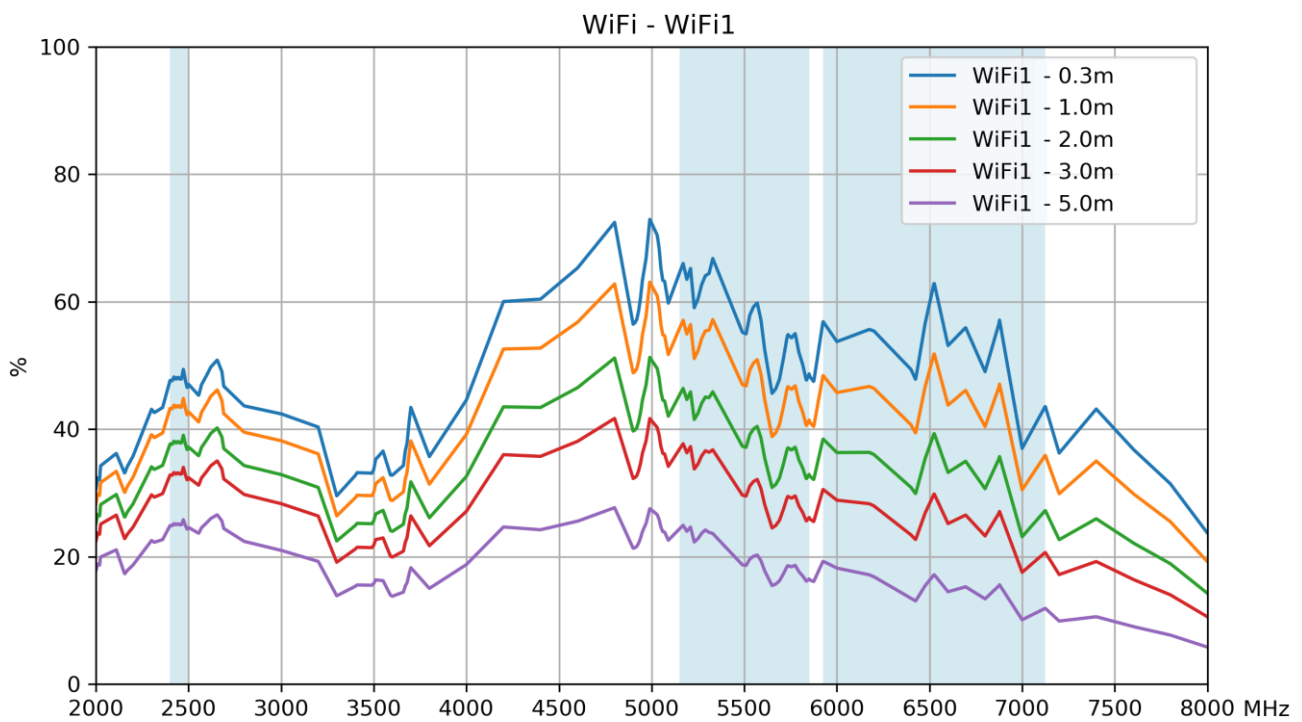

3.10 Efficiency – Wi-Fi MIMO 2

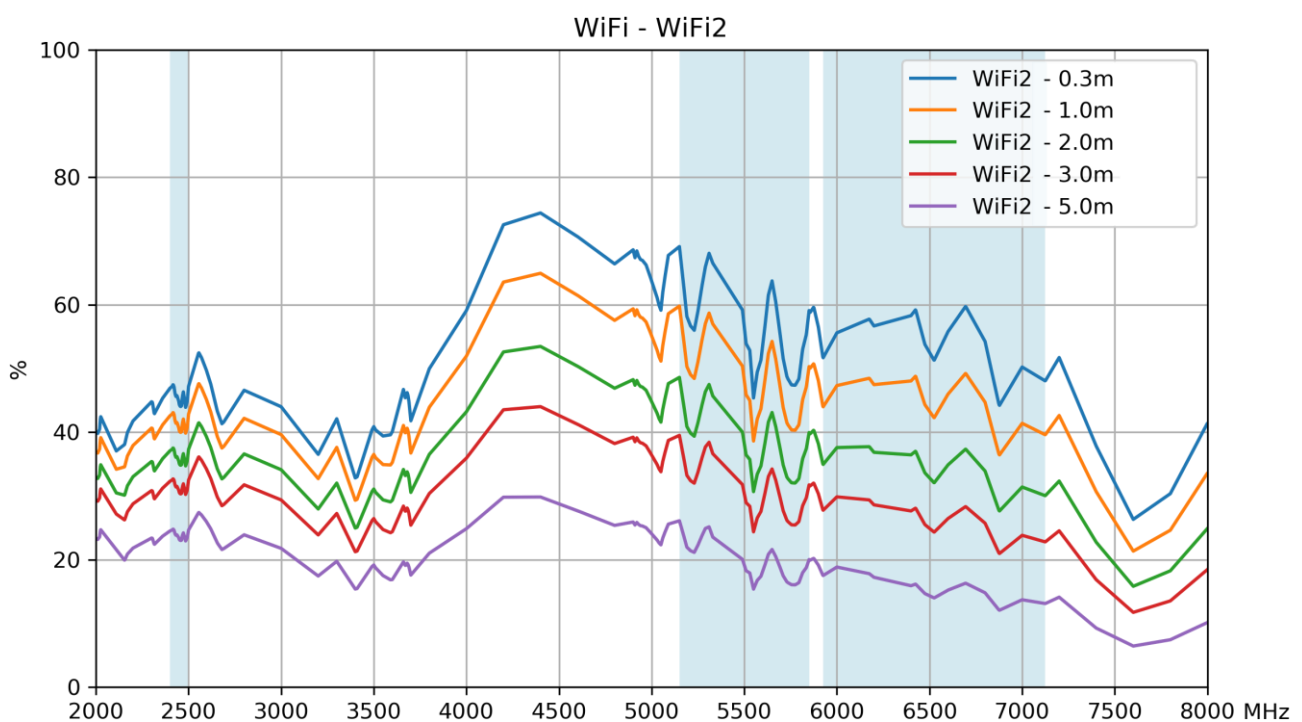

3.11 Efficiency – Wi-Fi MIMO 3

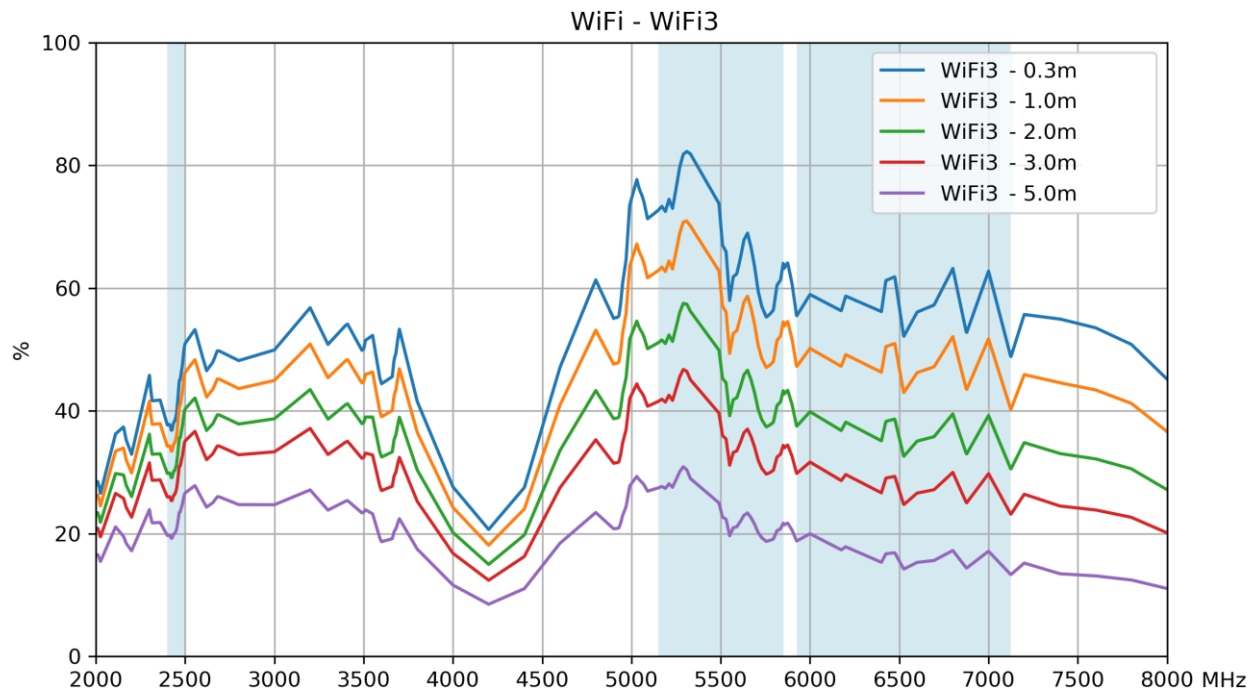

3.12 Efficiency – Wi-Fi MIMO 4

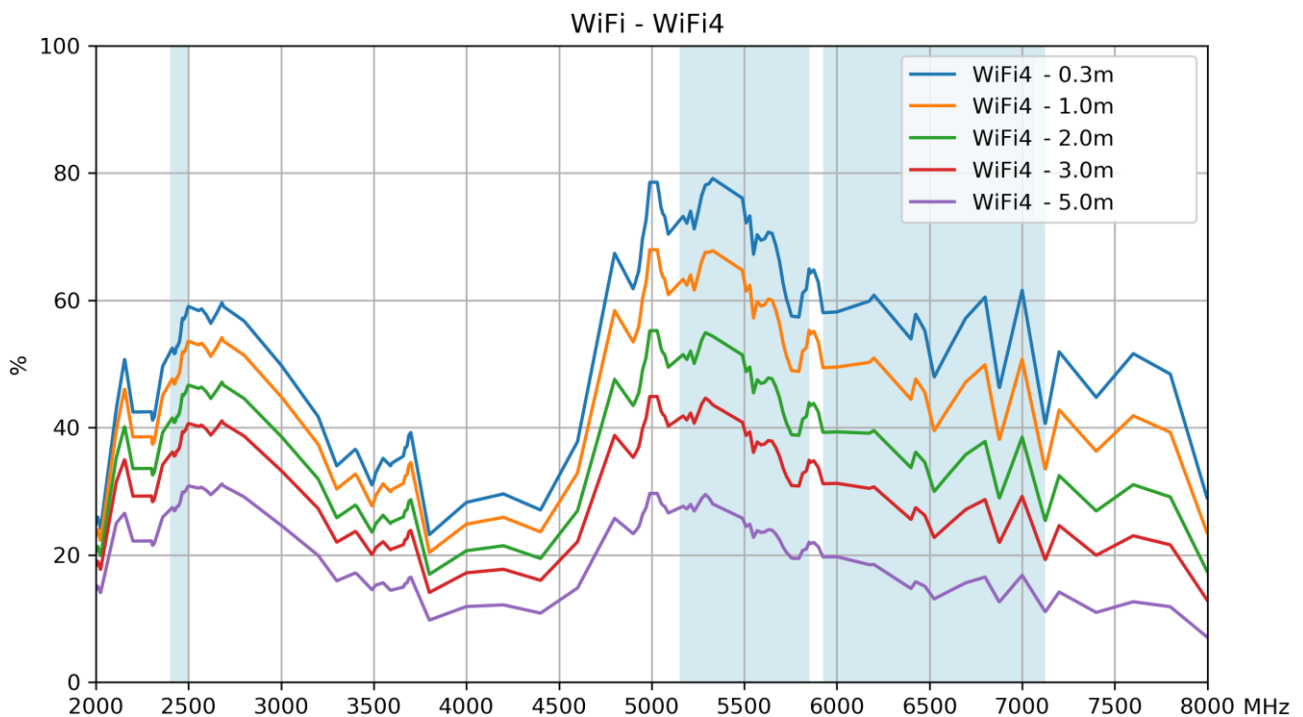

3.13 Average Gain – 5G/4G MIMO 1

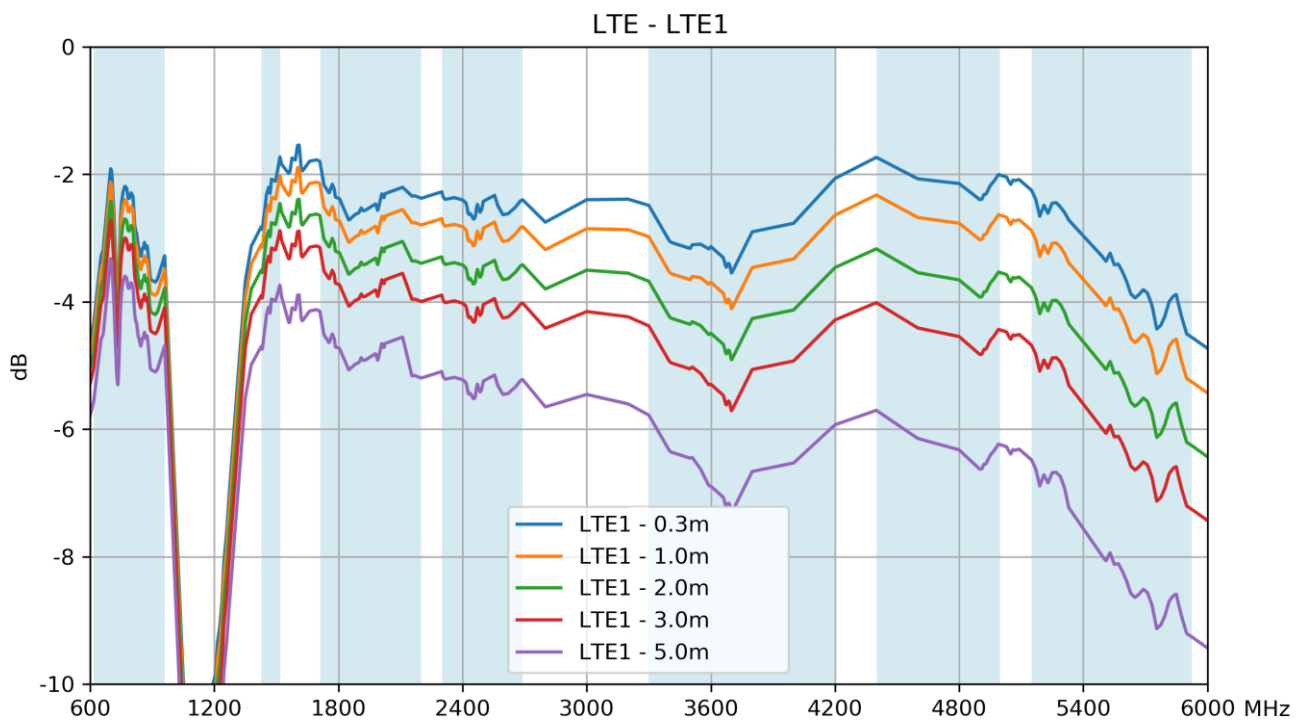

3.14 Average Gain – 5G/4G MIMO 2

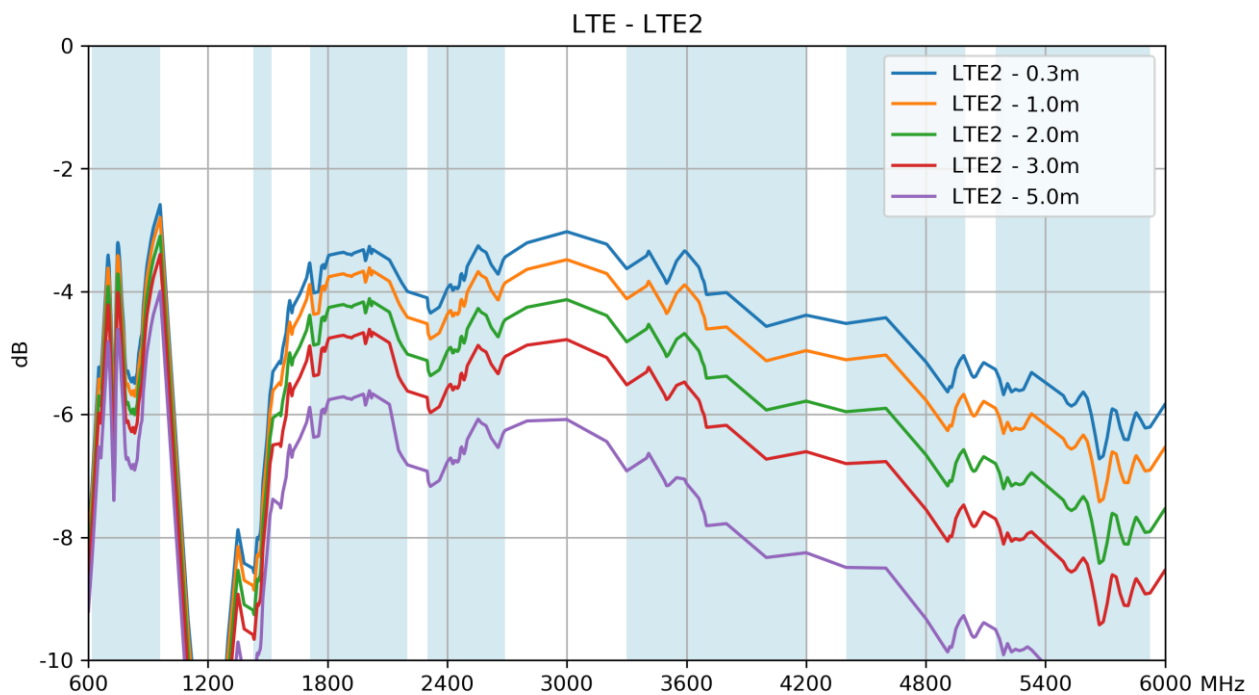

3.15 Average Gain – 5G/4G MIMO 3

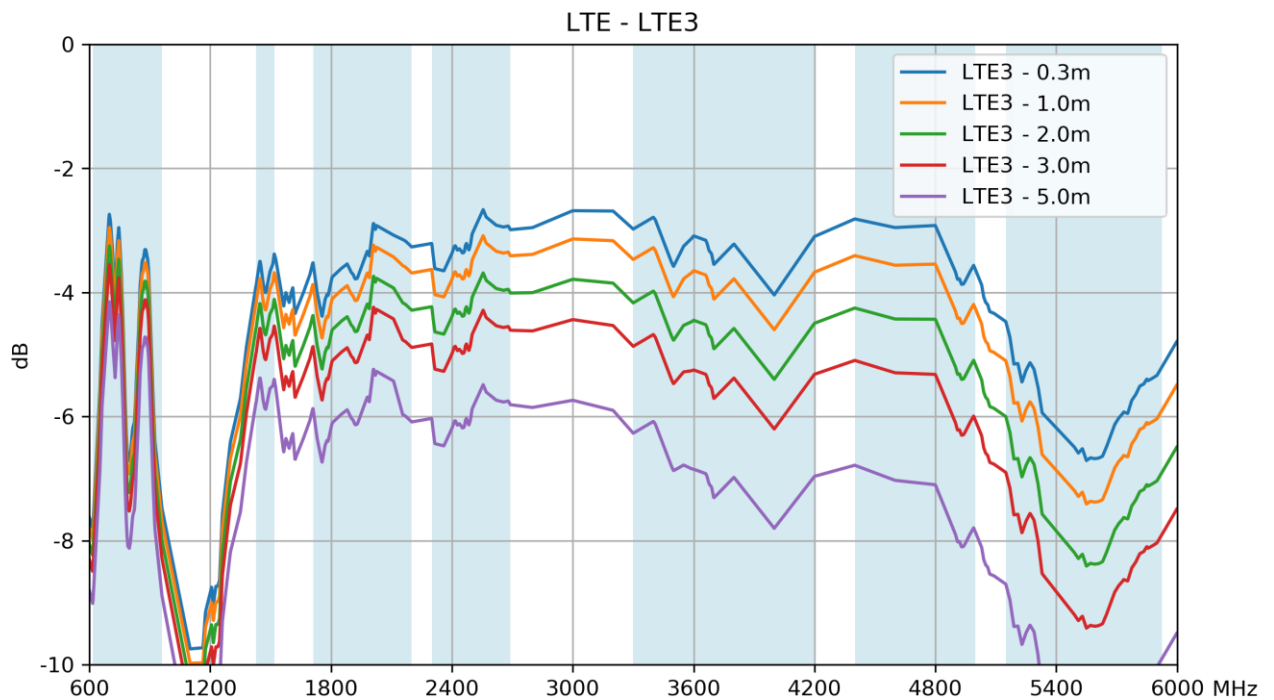

3.16 Average Gain – 5G/4G MIMO 4

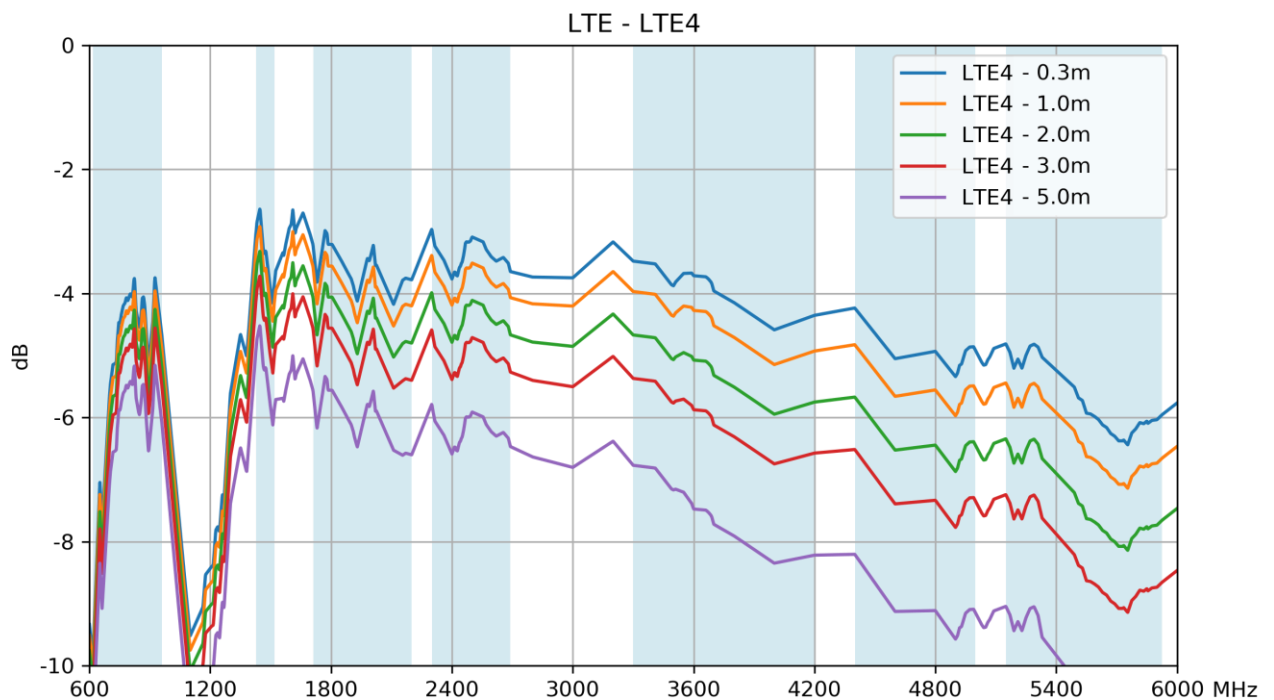

3.17 Average Gain – Wi-Fi MIMO 1

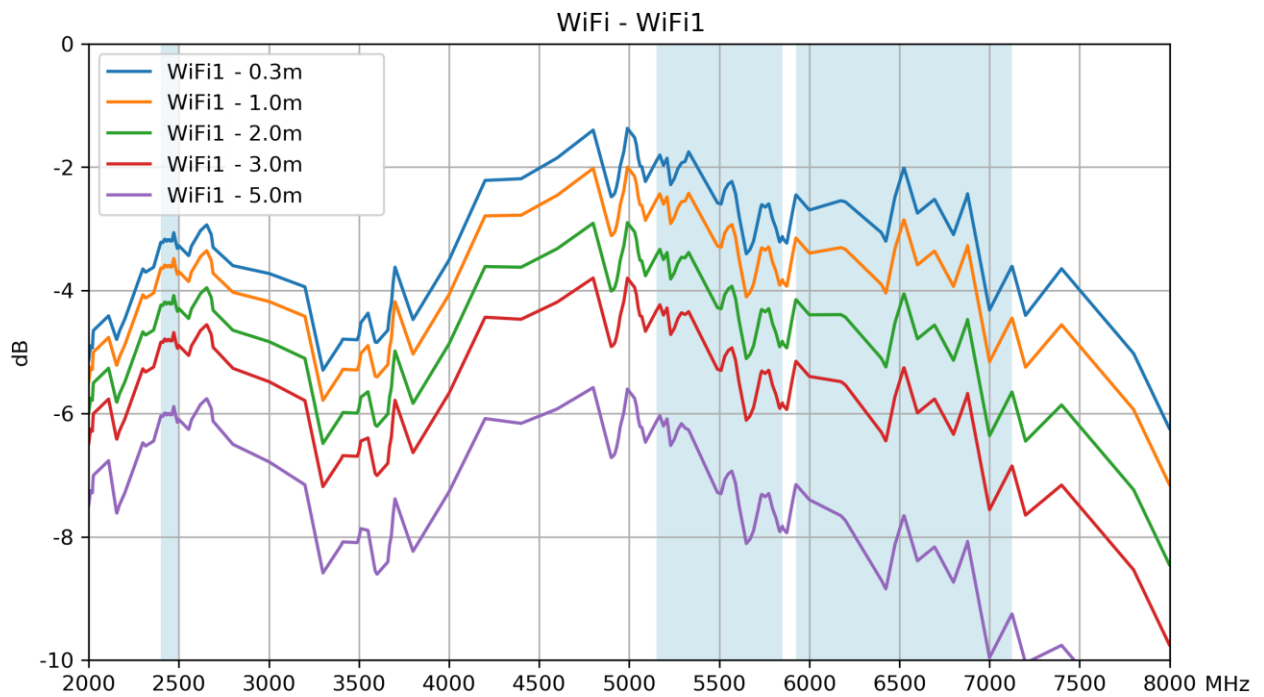

3.18 Average Gain – Wi-Fi MIMO 2

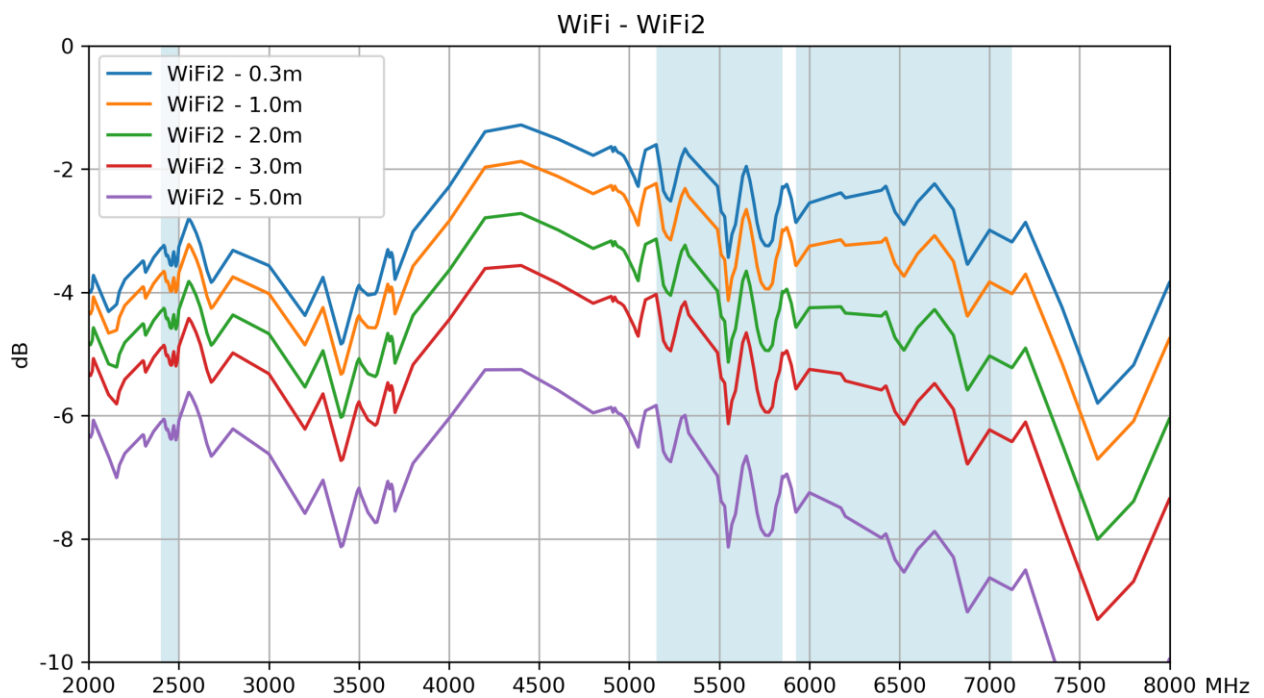

3.19 Average Gain – 5G/4G MIMO 3

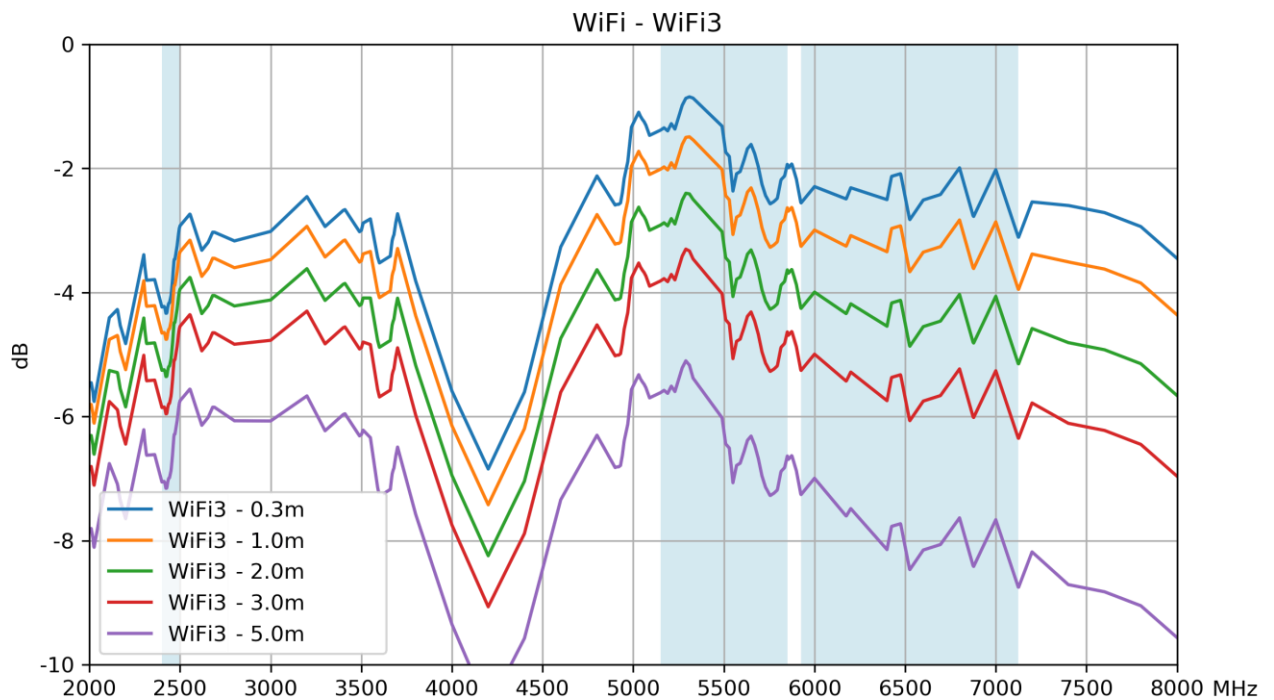

3.20 Average Gain – 5G/4G MIMO 4

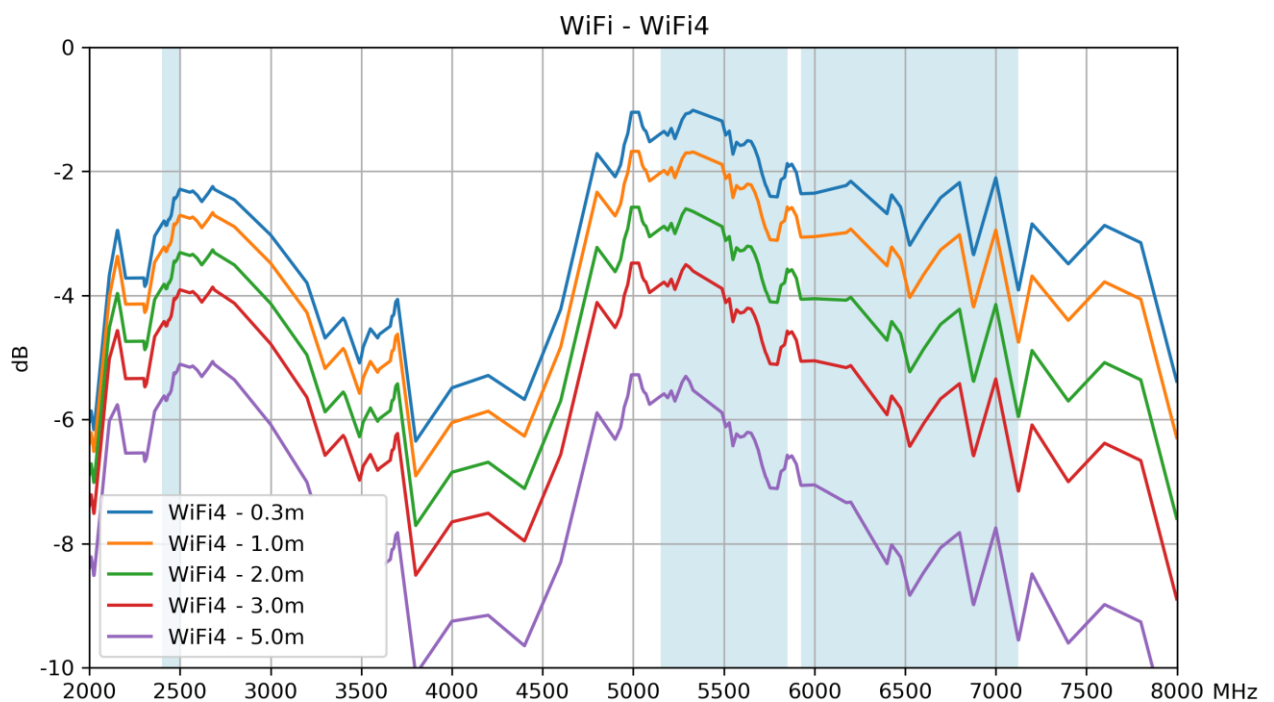

3.21 Peak Gain – 5G/4G MIMO 1

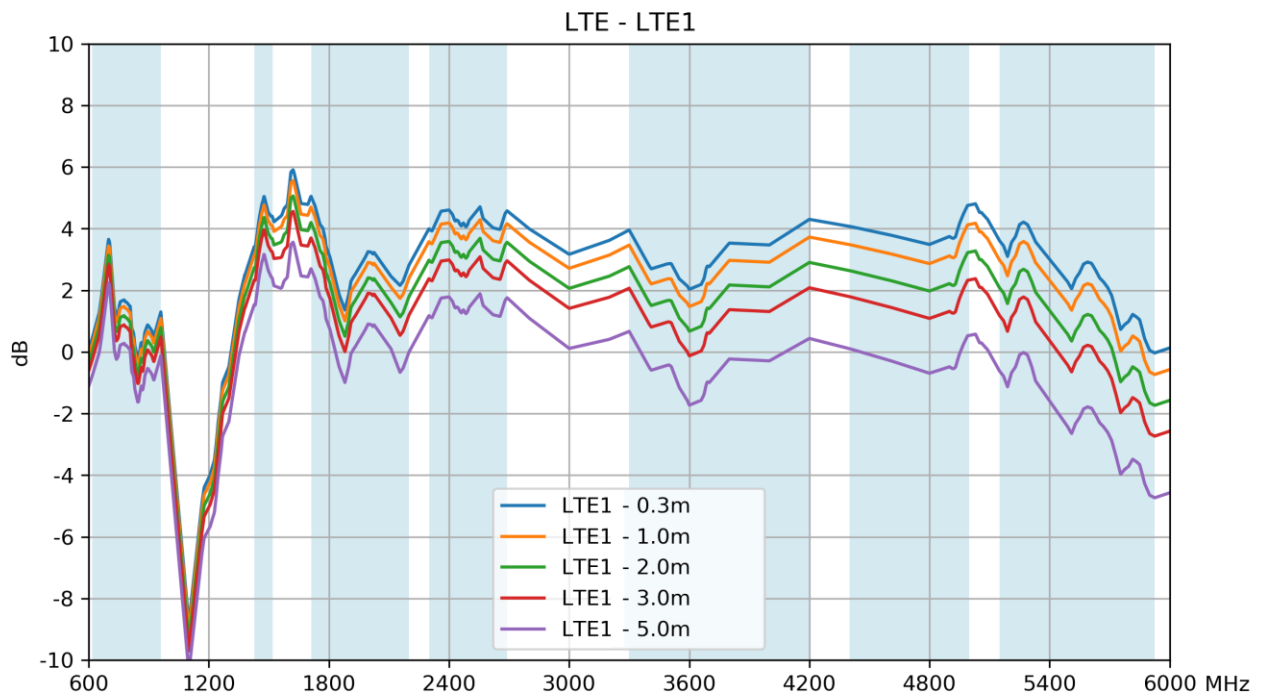

3.22 Peak Gain – 5G/4G MIMO 2

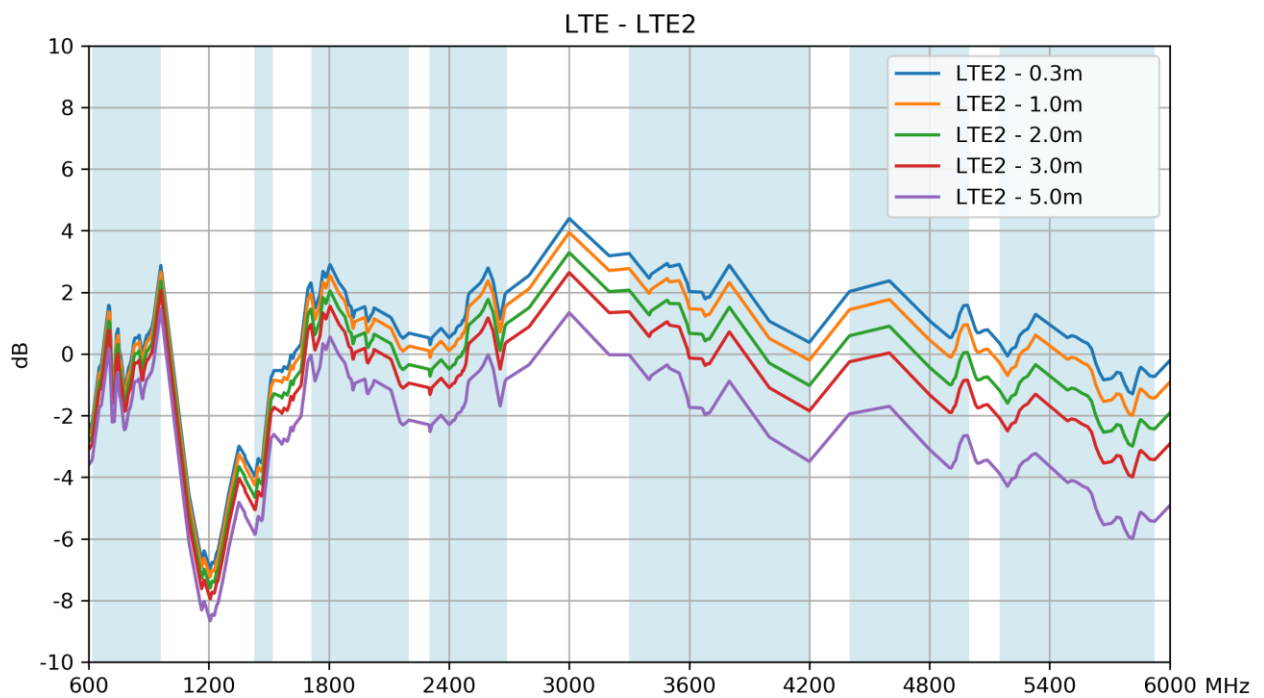

3.23 Peak Gain – 5G/4G MIMO 3

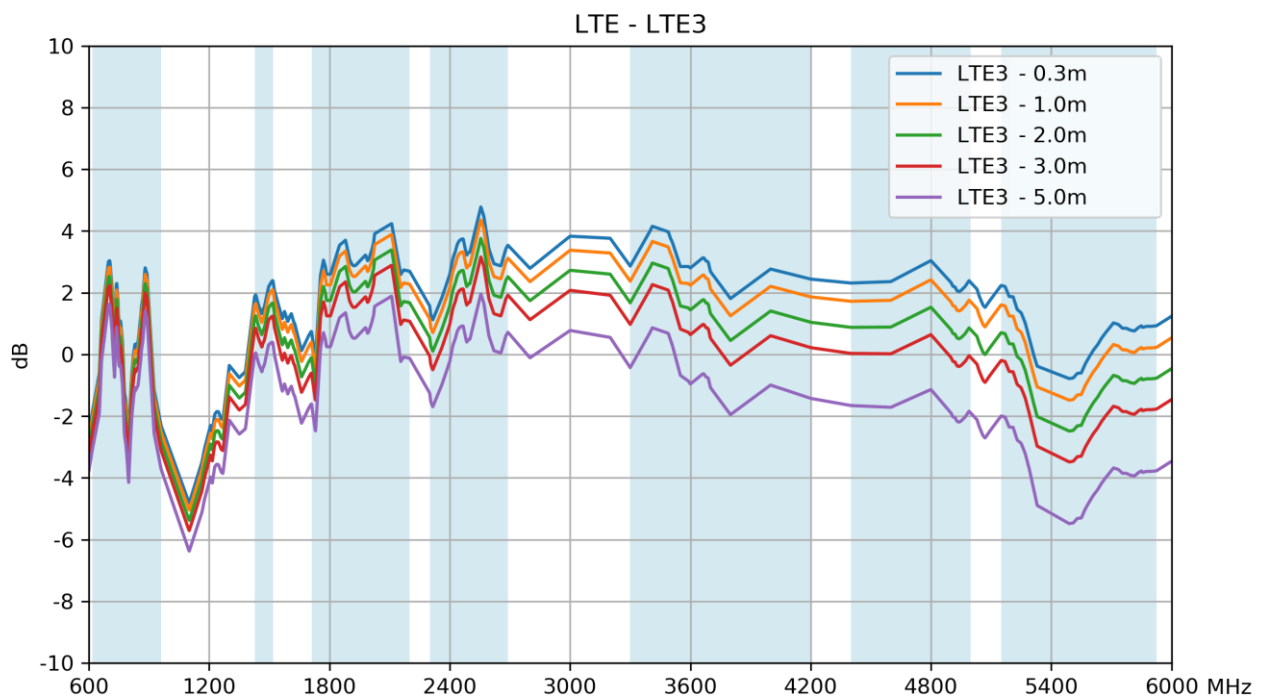

3.24 Peak Gain – 5G/4G MIMO 4

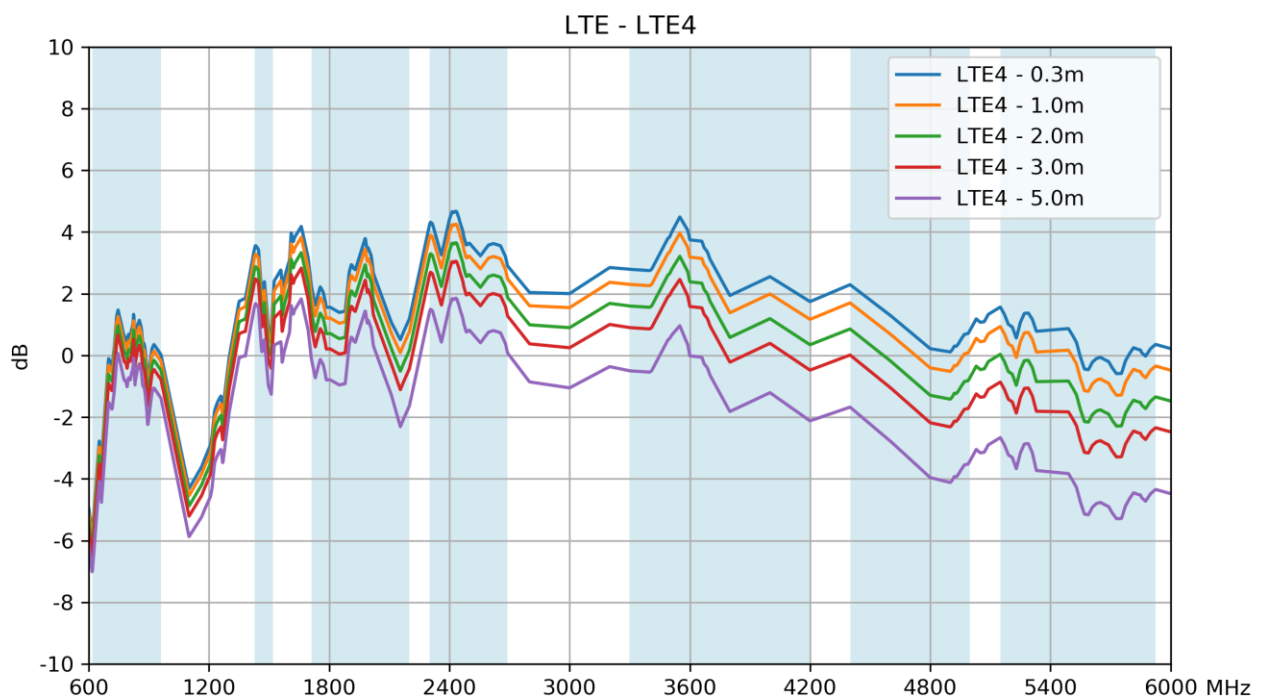

3.25 Peak Gain – Wi-Fi MIMO 1

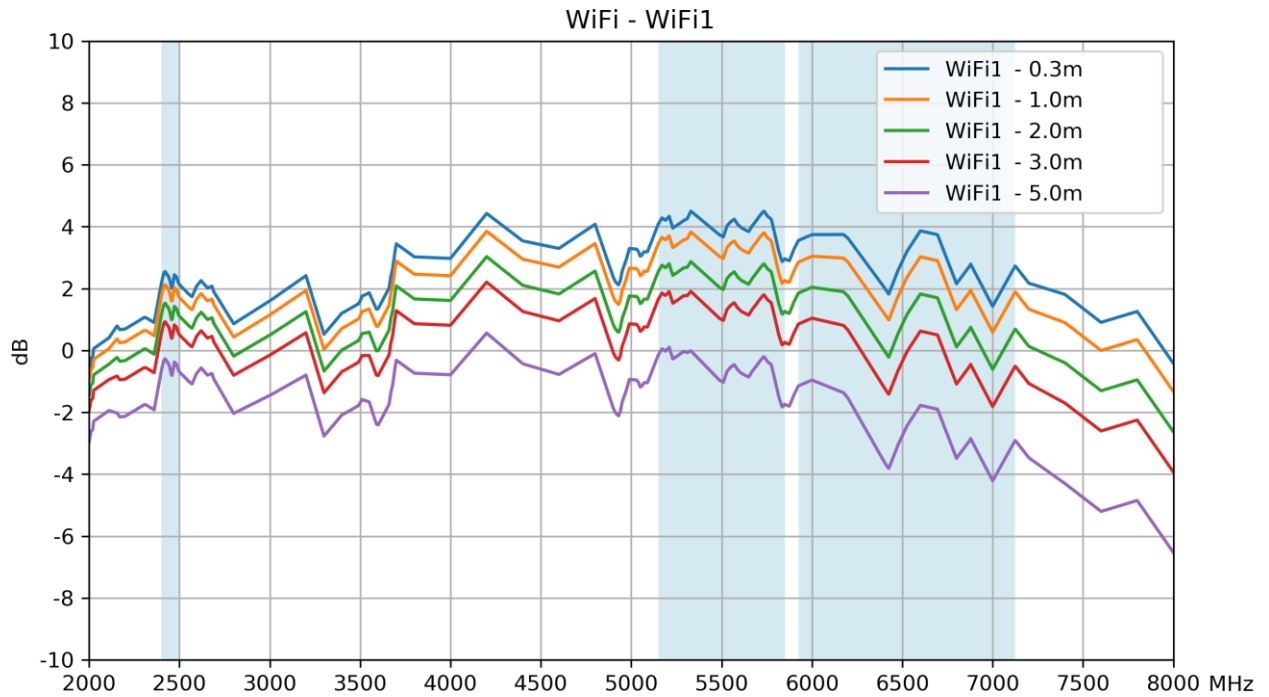

3.26 Peak Gain – Wi-Fi MIMO 2

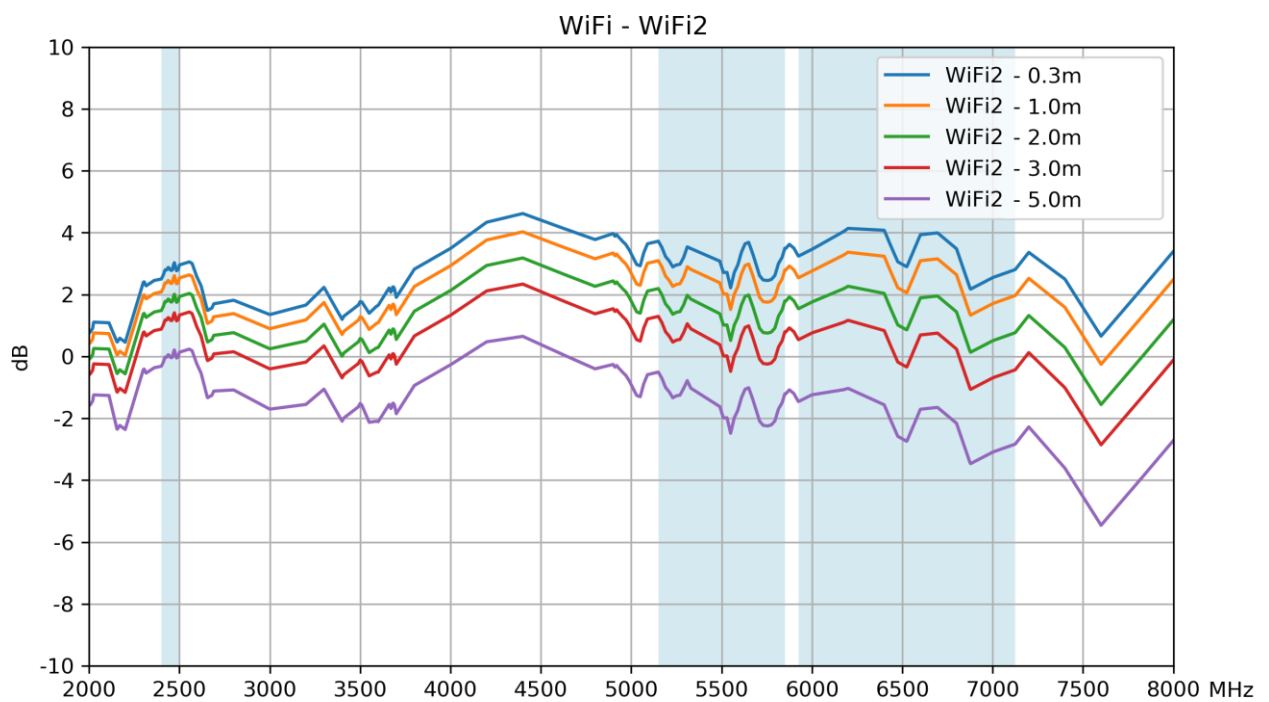

3.27 Peak Gain –Wi-Fi MIMO 3

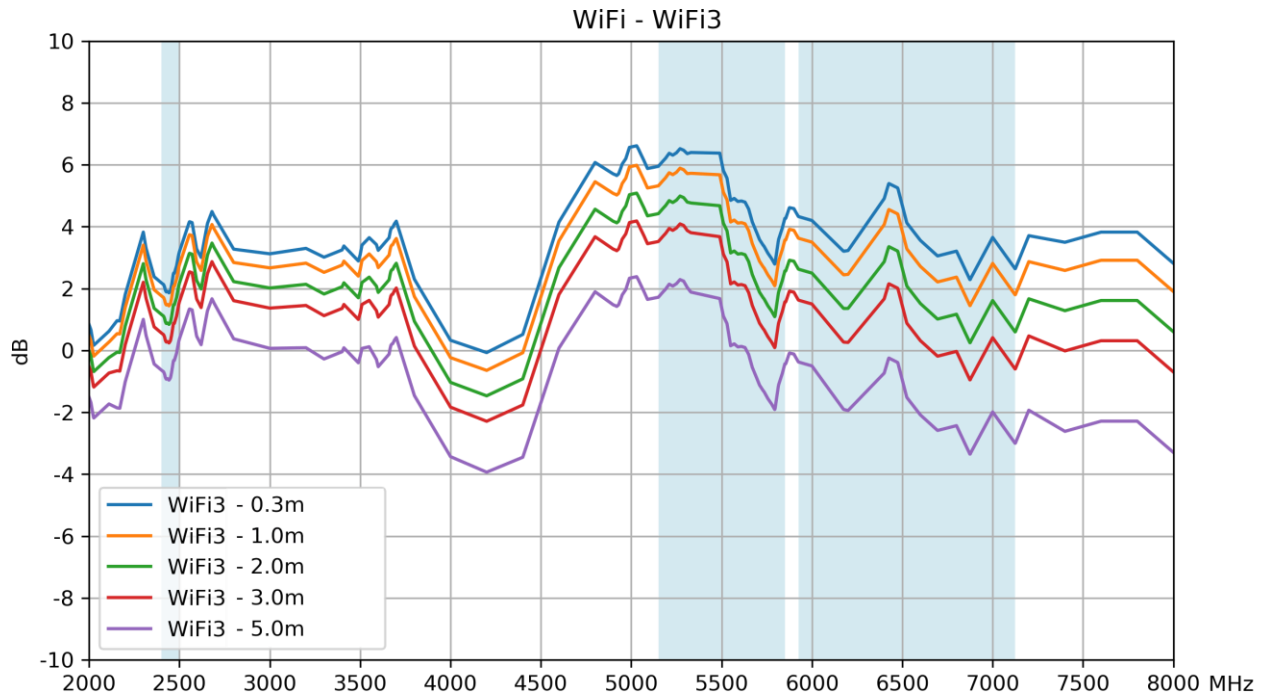

3.28 Peak Gain –Wi-Fi MIMO 4

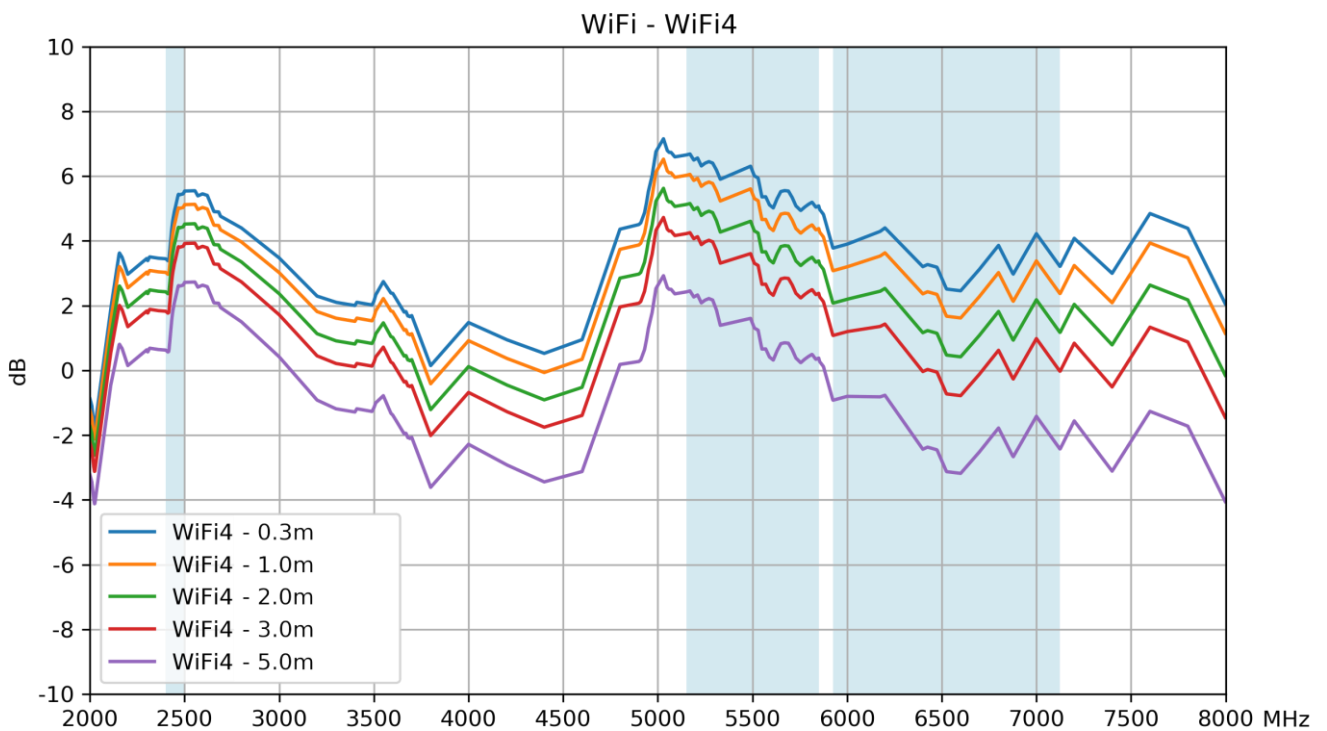

4. Active Antenna Characteristics

4.1 Block Diagram

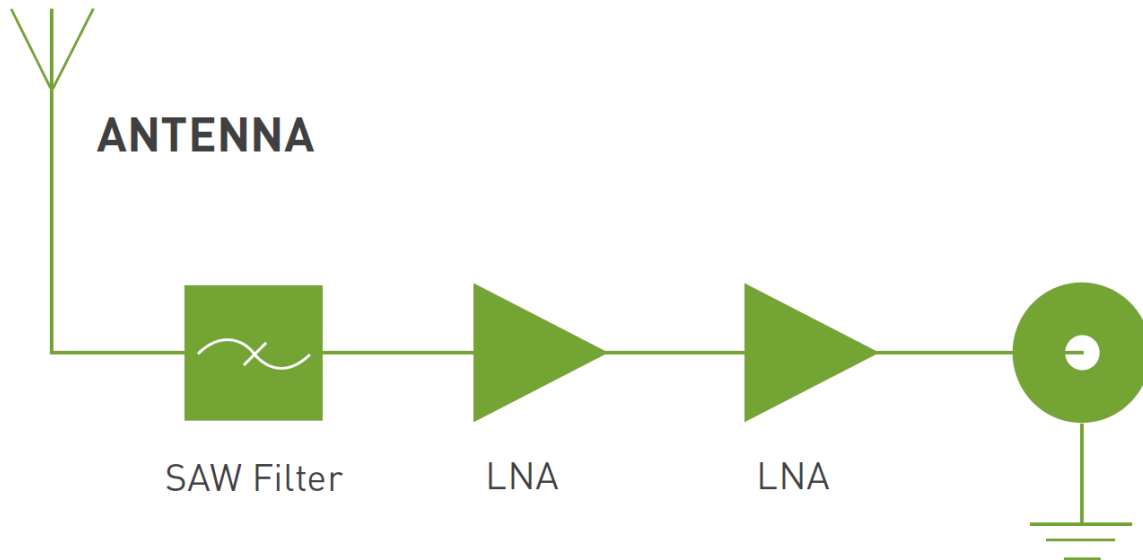

4.2 Axial Ratio

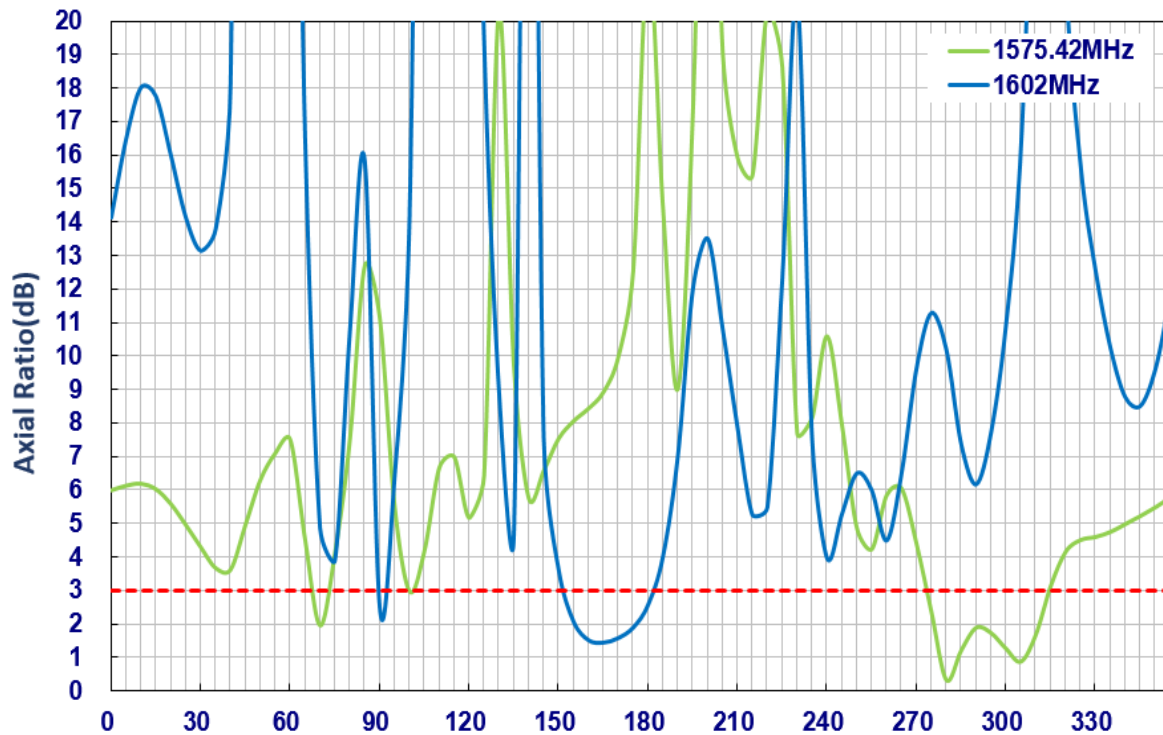

4.3 LNA Gain @3.0V

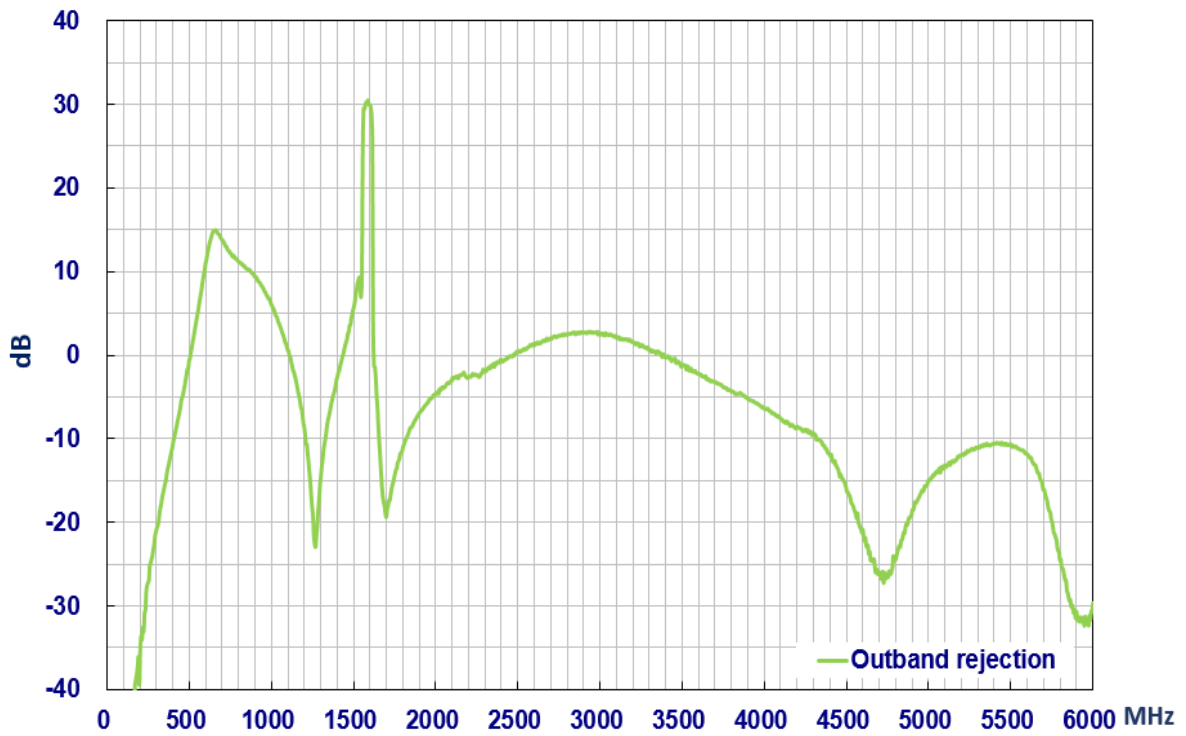

4.4 Noise Figure @3.0V

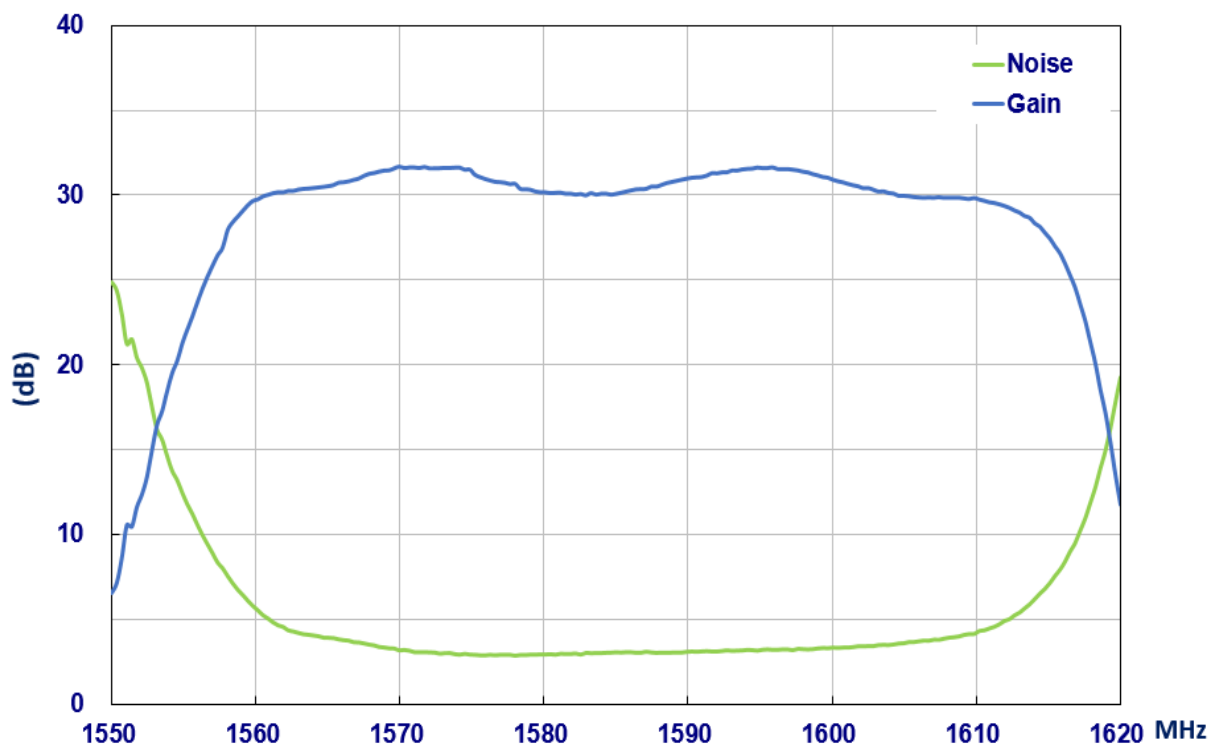

5. Radiation Patterns

5.1 GNSS 3D and 2D Radiation Patterns

1575.42MHz

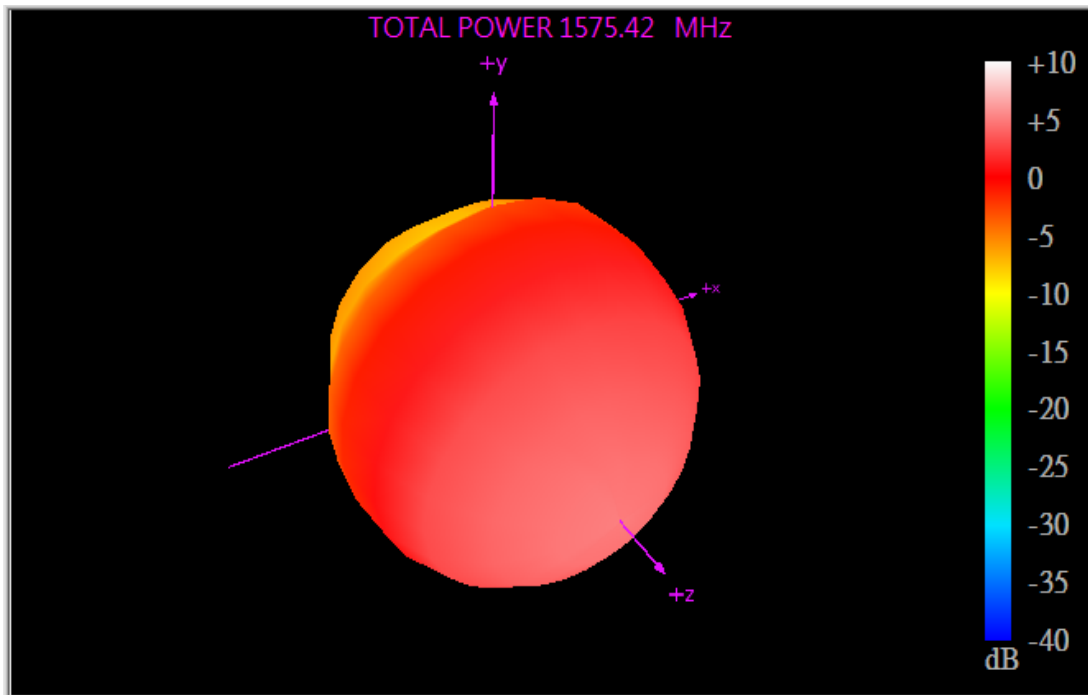

XY Plane

XZ Plane

YZ Plane

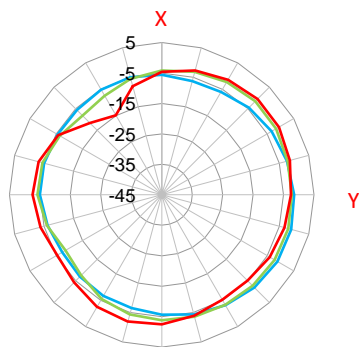

— 1561MHz
— 1575.42MHz
— 1602MHz

(dBi)

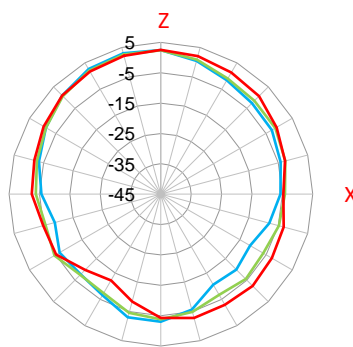

— 1561MHz
— 1575.42MHz
— 1602MHz

(dBi)

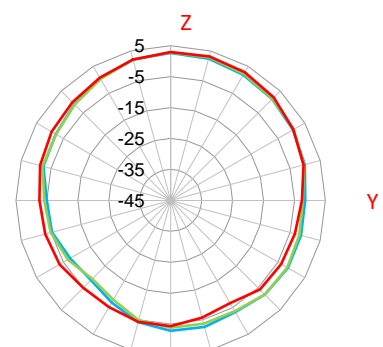

— 1561MHz
— 1575.42MHz
— 1602MHz

(dBi)

5.2 5G/4G MIMO 1 3D and 2D Radiation Patterns

652MHz

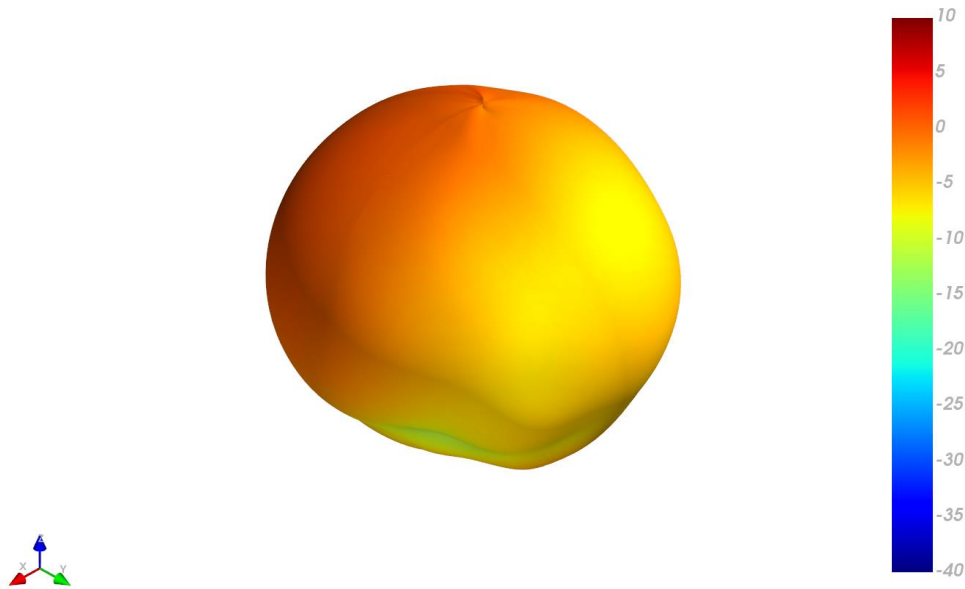

XY Plane

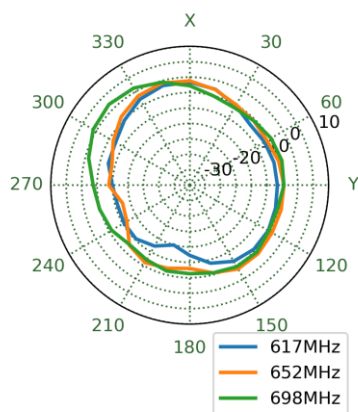

XZ Plane

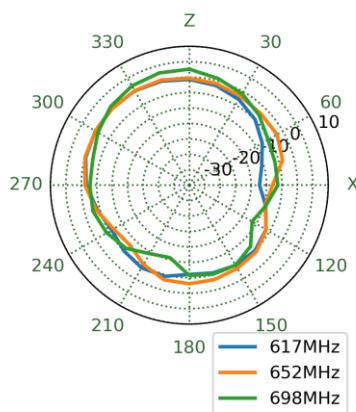

YZ Plane

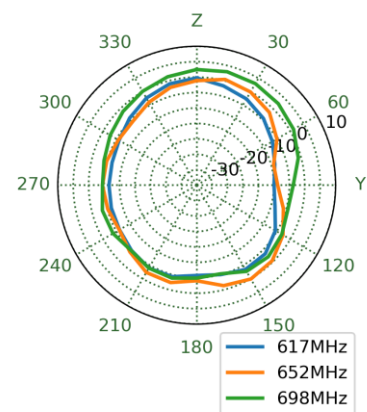

751MHz

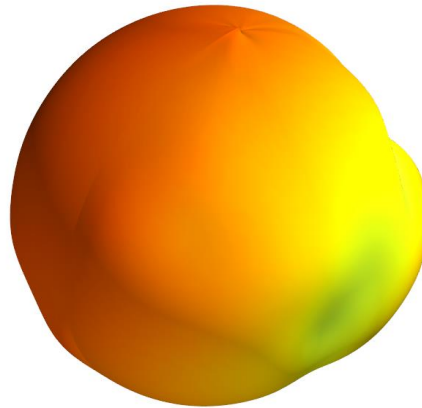

XY Plane

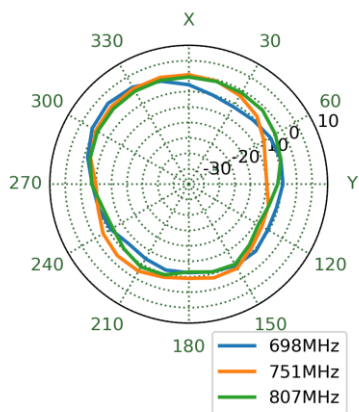

XZ Plane

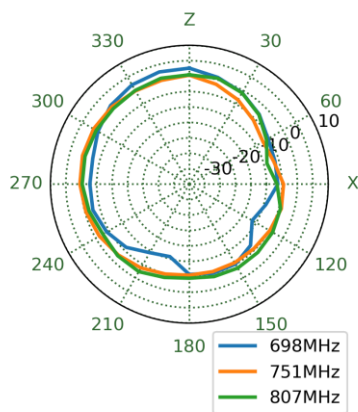

YZ Plane

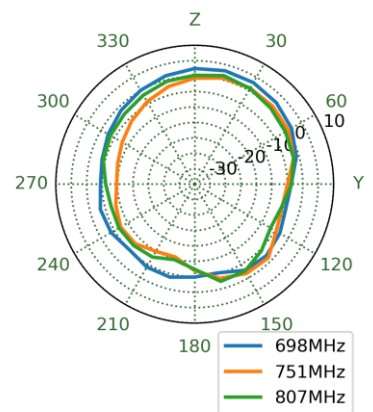

890MHz

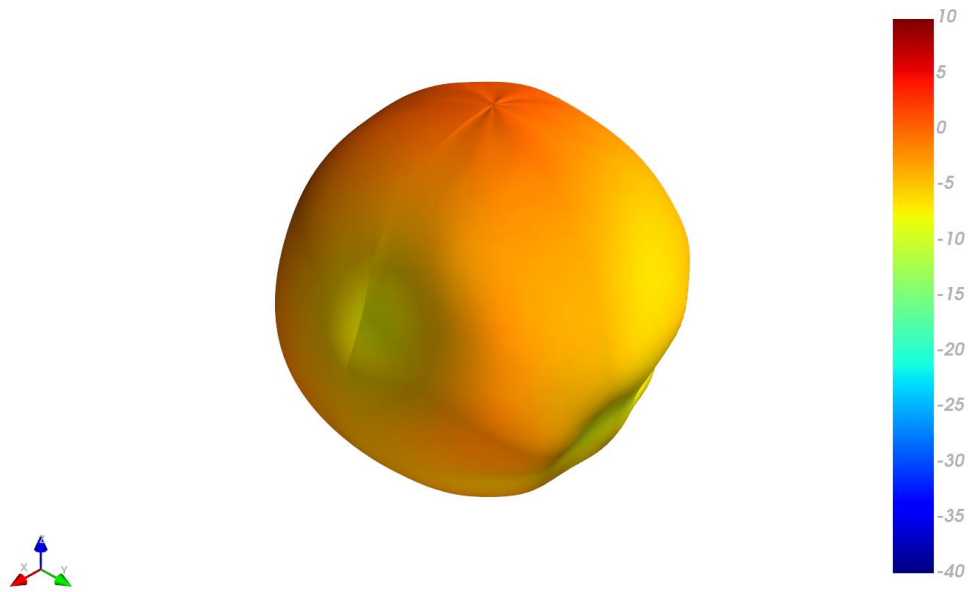

XY Plane

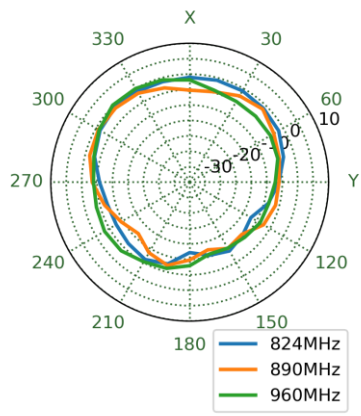

XZ Plane

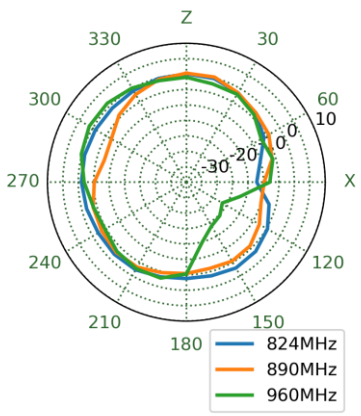

YZ Plane

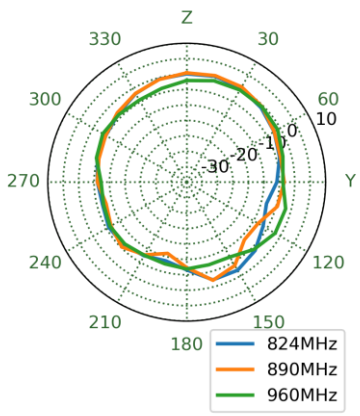

1470MHz

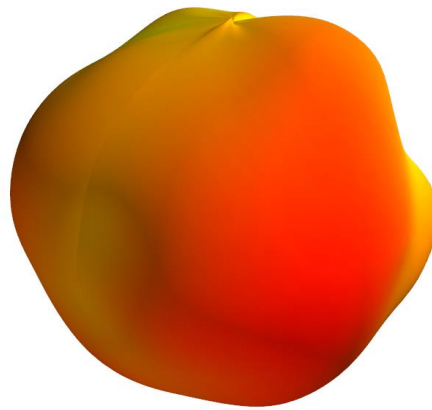

XY Plane

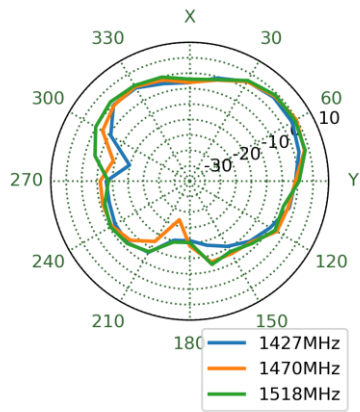

XZ Plane

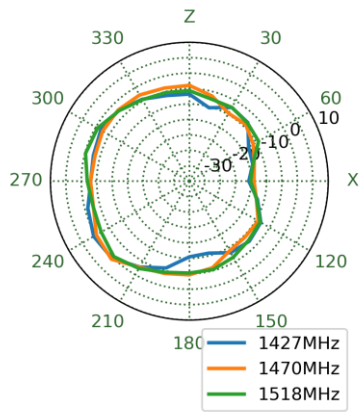

YZ Plane

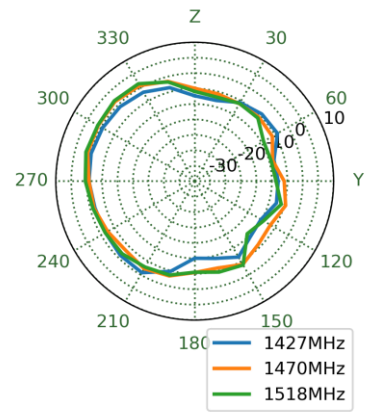

1805MHz

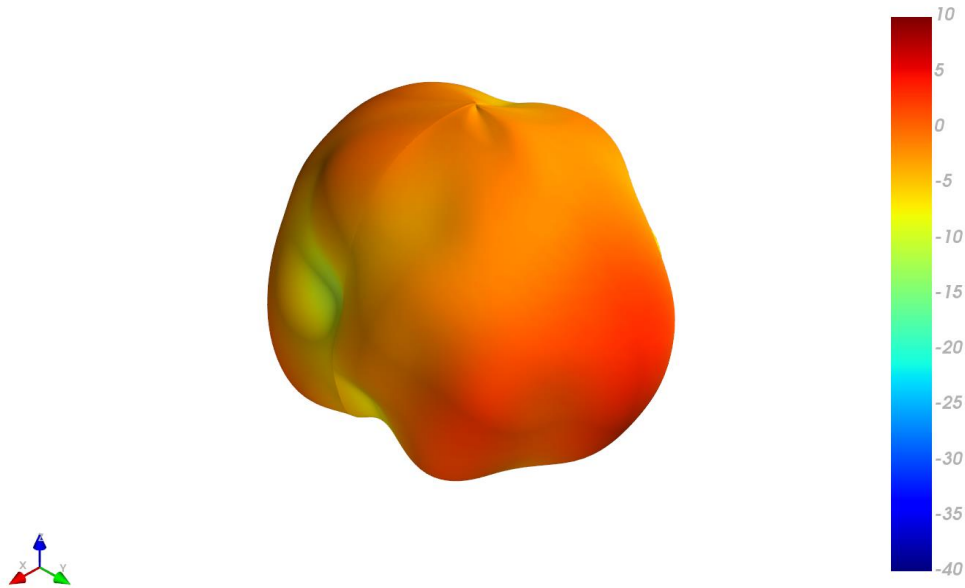

XY Plane

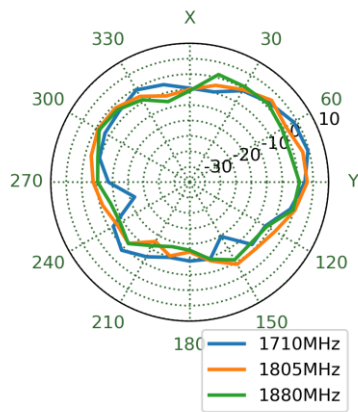

XZ Plane

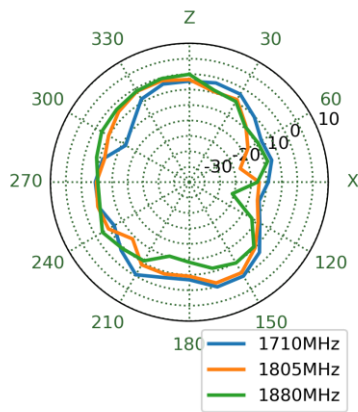

YZ Plane

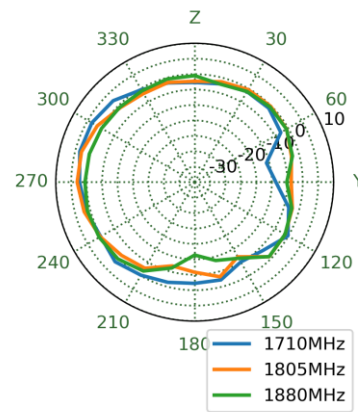

1920MHz

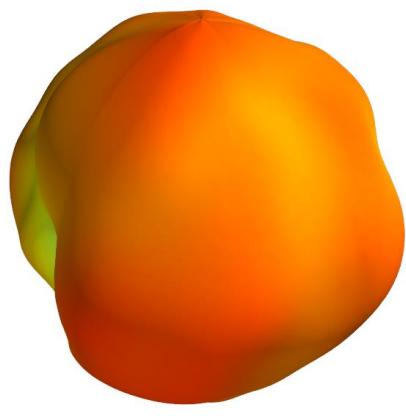

XY Plane

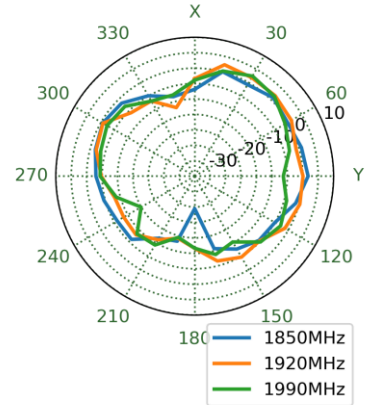

XZ Plane

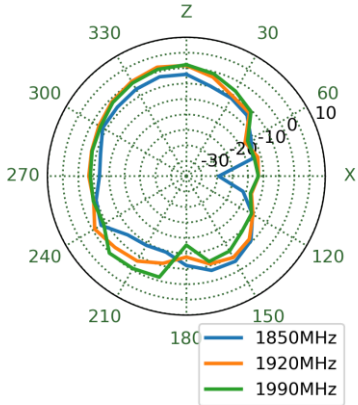

YZ Plane

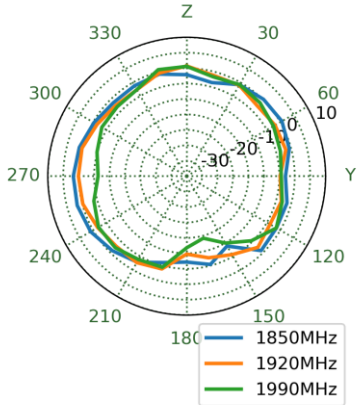

1990MHz

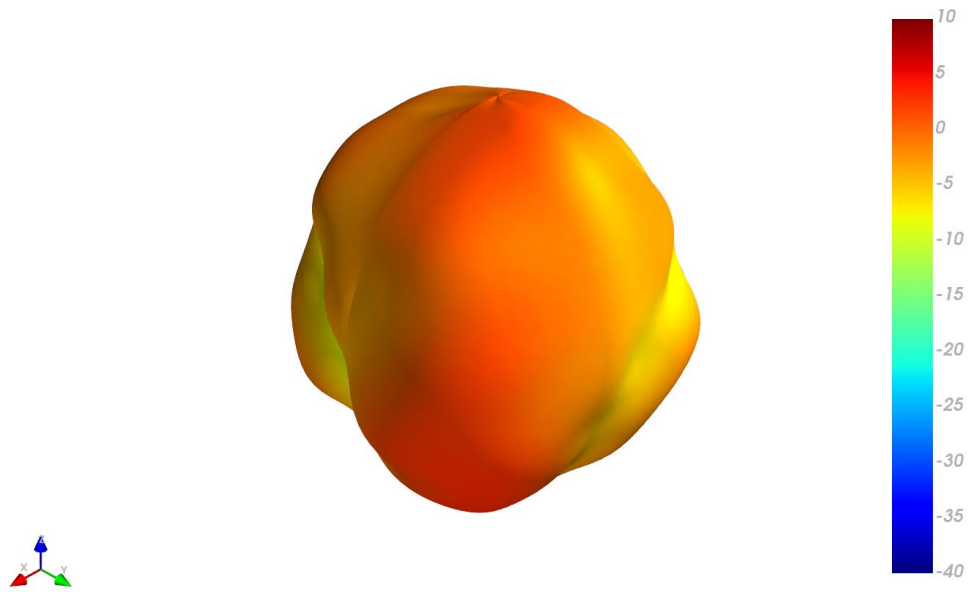

XY Plane

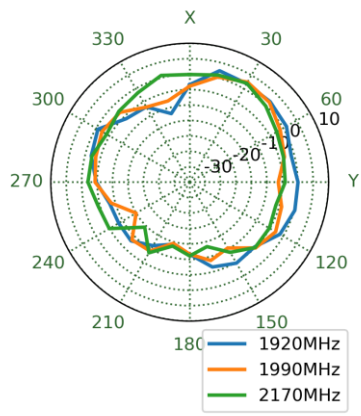

XZ Plane

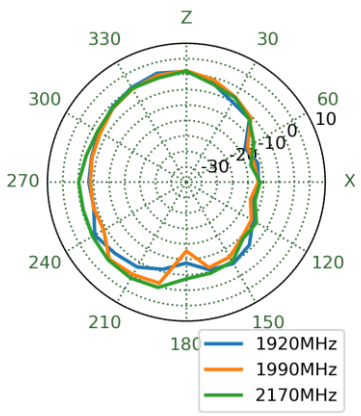

YZ Plane

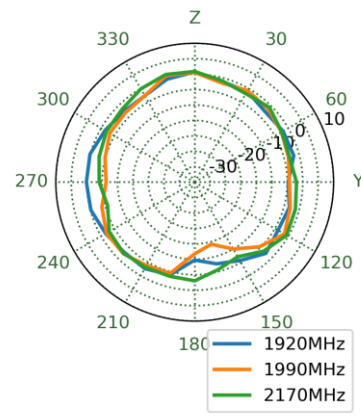

2595MHz

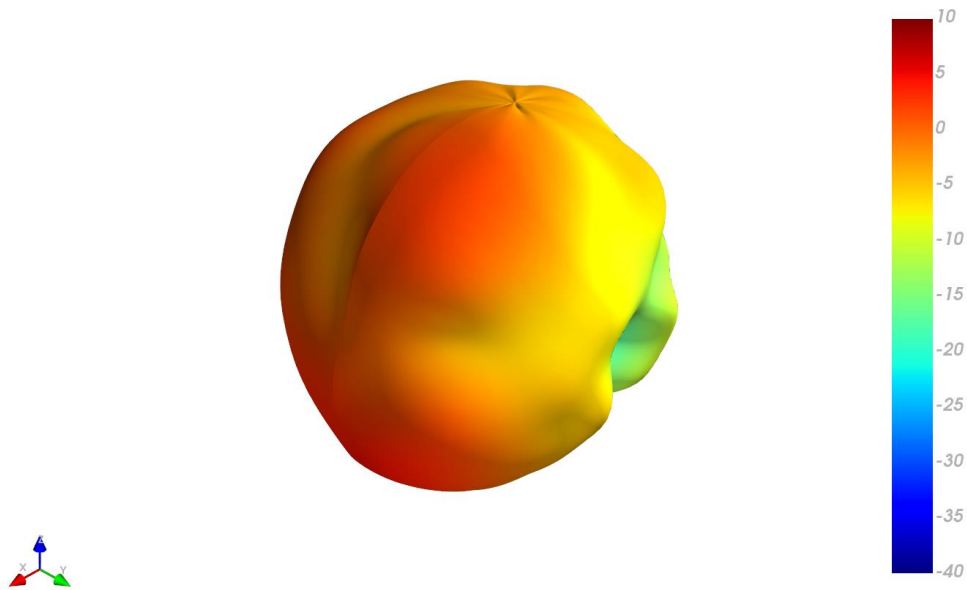

XY Plane

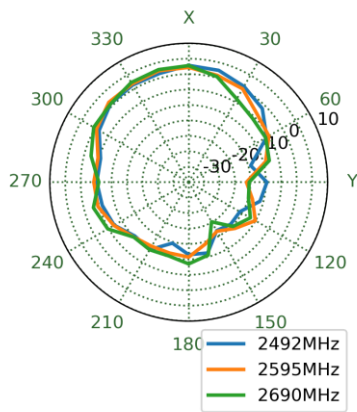

XZ Plane

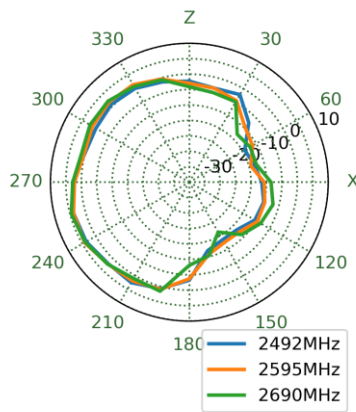

YZ Plane

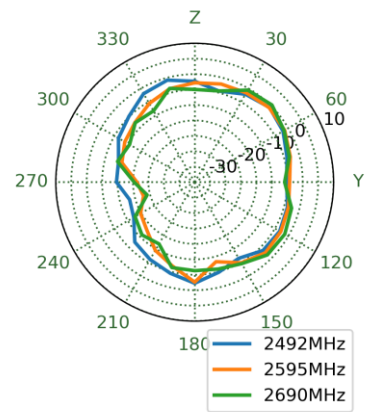

3550MHz

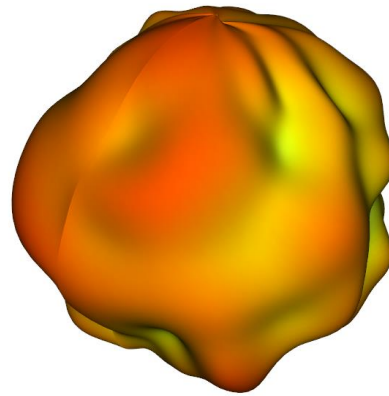

XY Plane XZ Plane YZ Plane

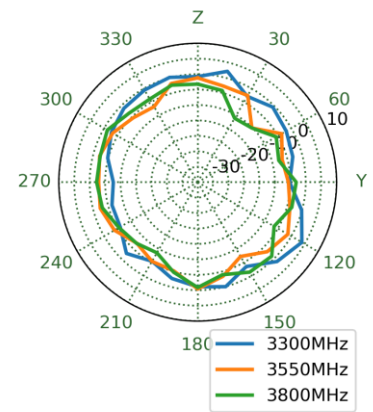
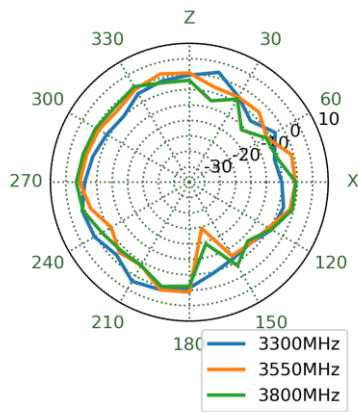
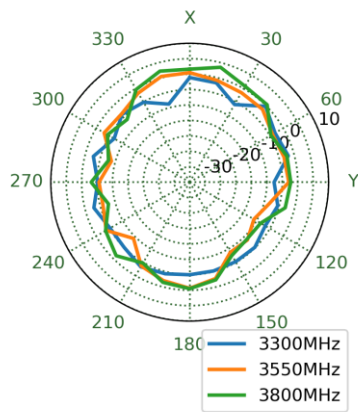

5.3 5G/4G MIMO 2 3D and 2D Radiation Patterns

652MHz

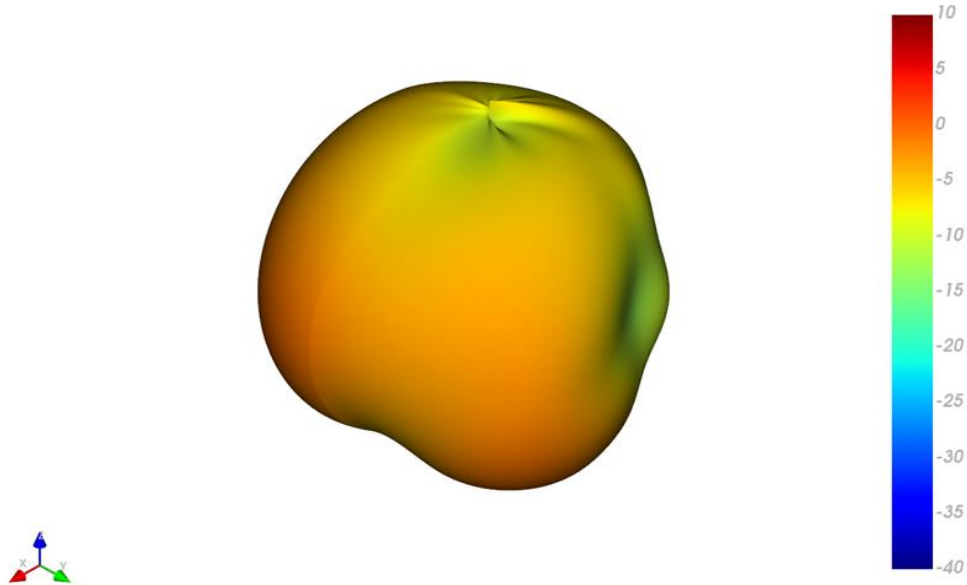

XY Plane

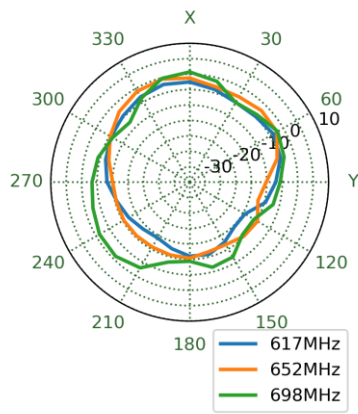

XZ Plane

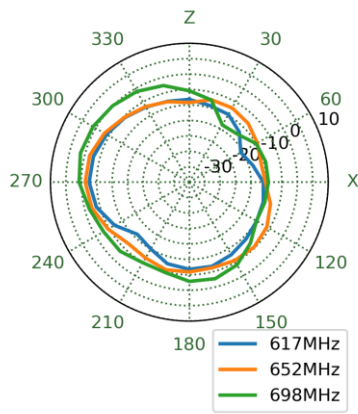

YZ Plane

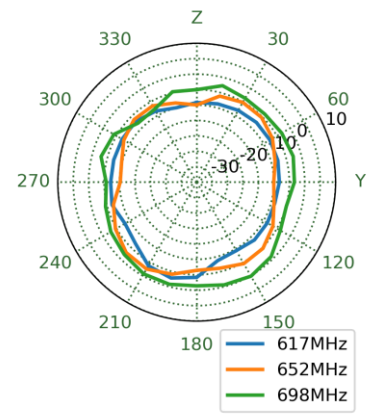

751MHz

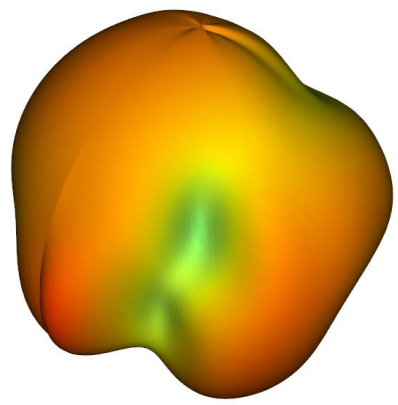

XY Plane

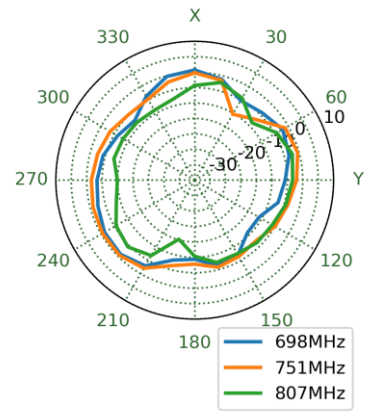

XZ Plane

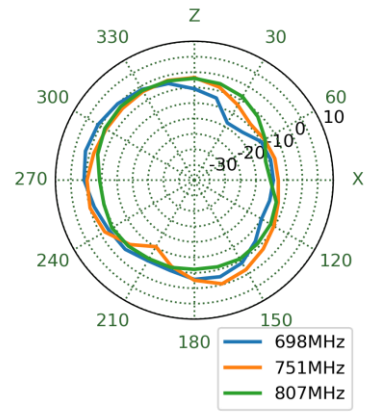

YZ Plane

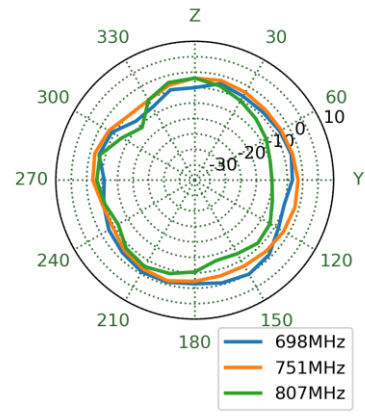

890MHz

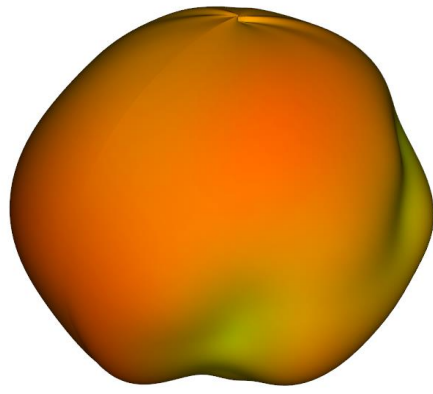

XY Plane

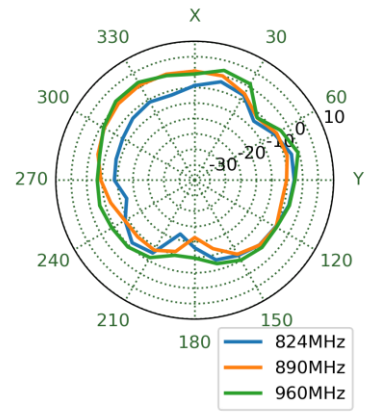

XZ Plane

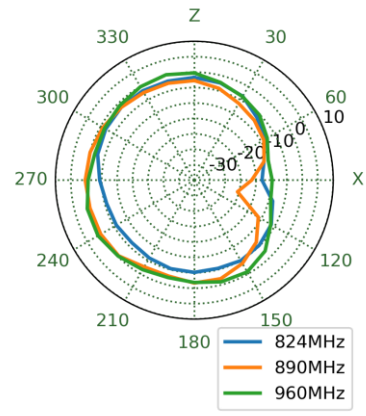

YZ Plane

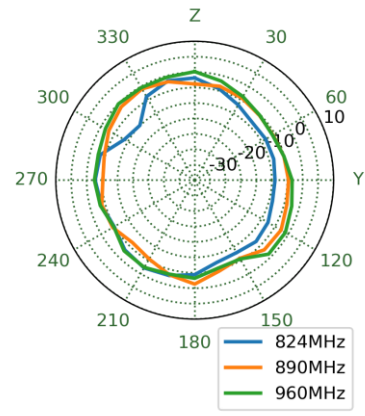

1470MHz

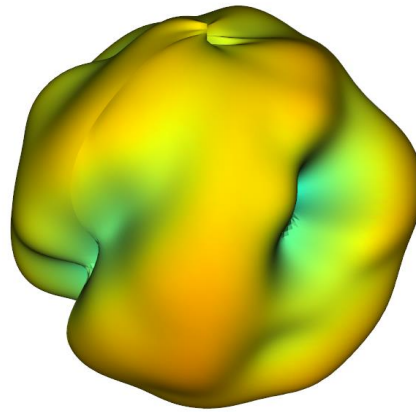

XY Plane

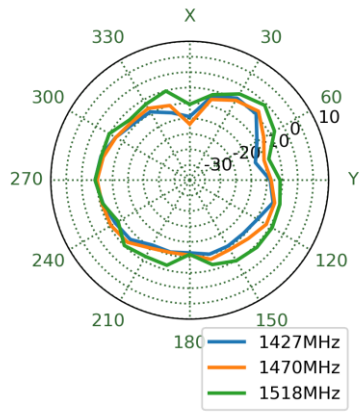

XZ Plane

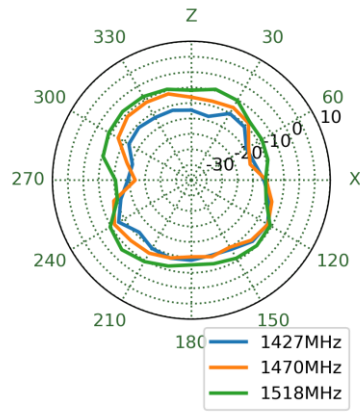

YZ Plane

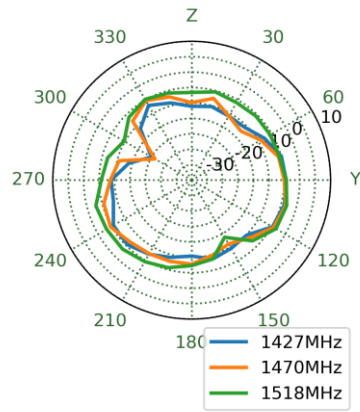

1805MHz

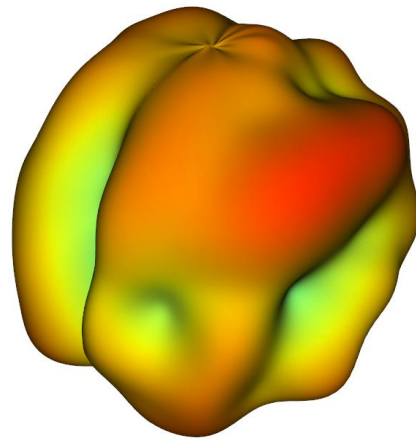

XY Plane XZ Plane YZ Plane

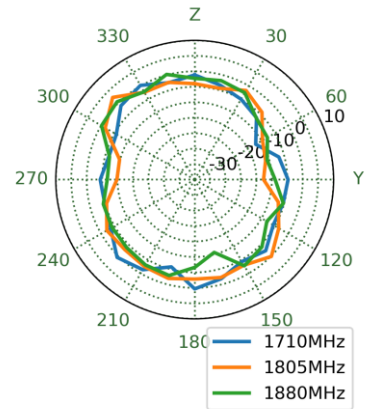
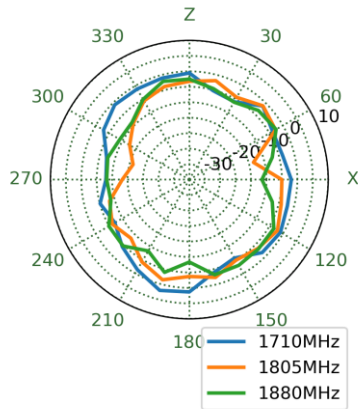
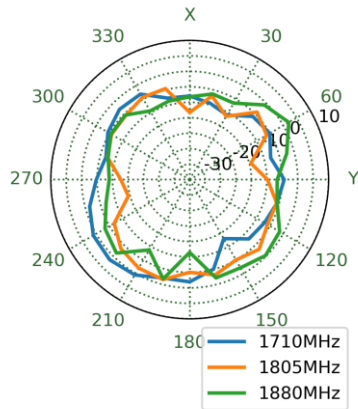

1920MHz

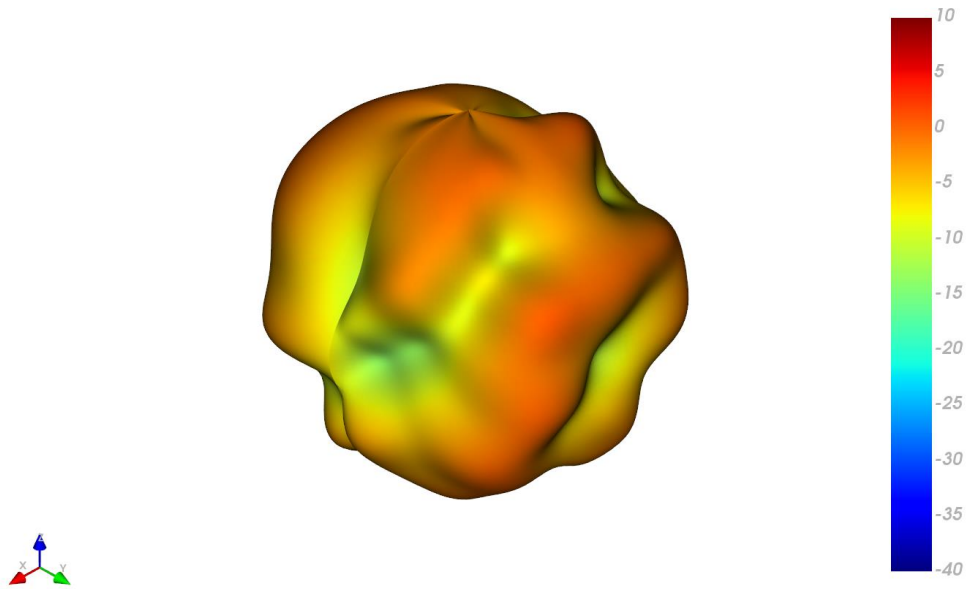

XY Plane

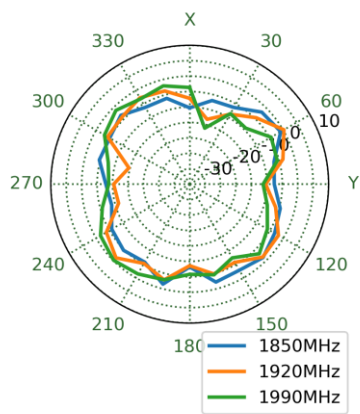

XZ Plane

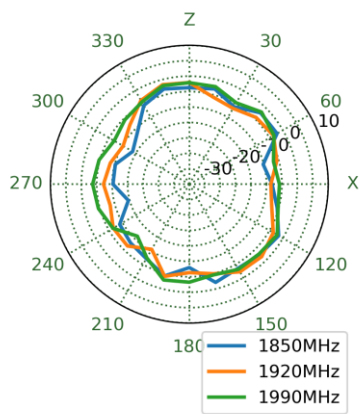

YZ Plane

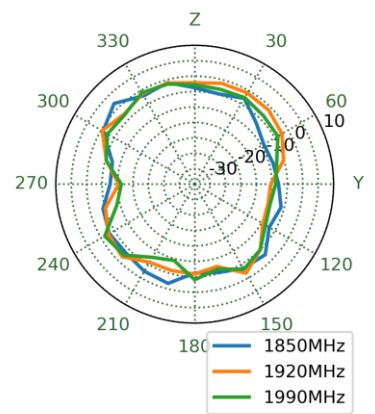

1990MHz

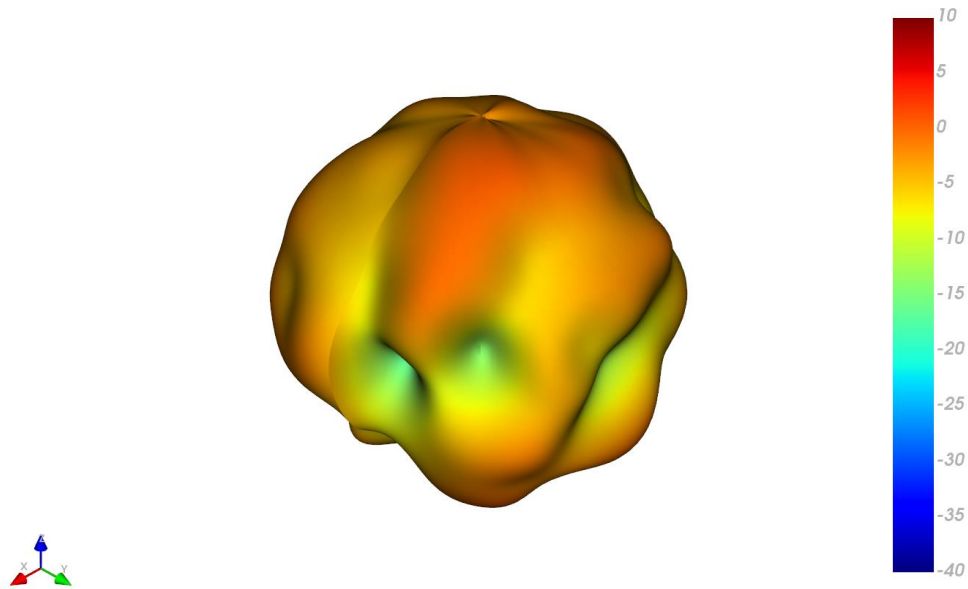

XY Plane

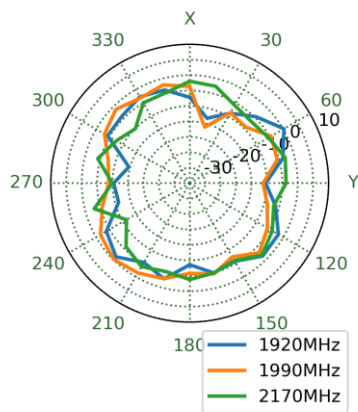

XZ Plane

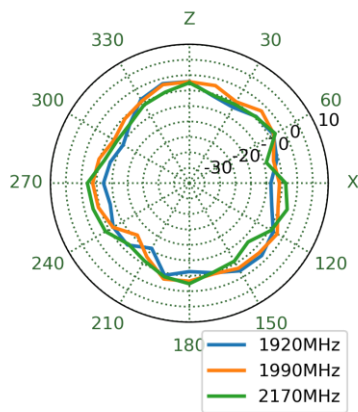

YZ Plane

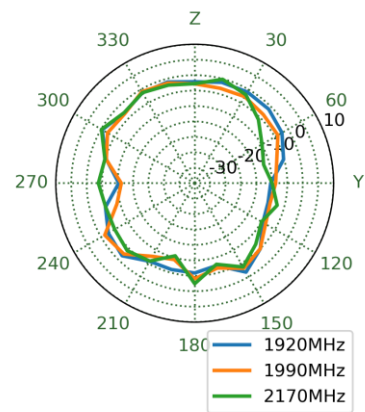

2595MHz

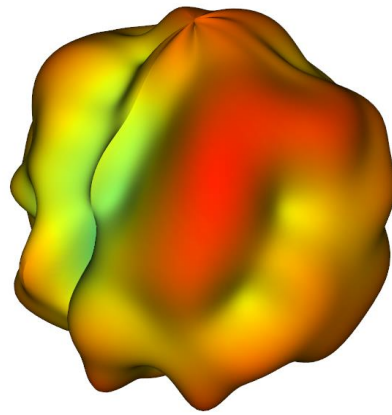

XY Plane

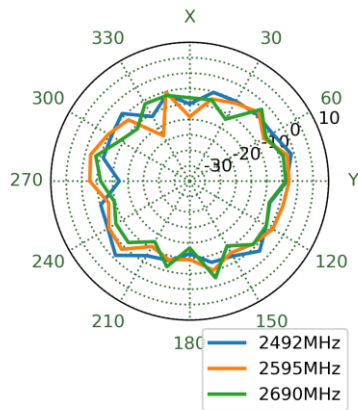

XZ Plane

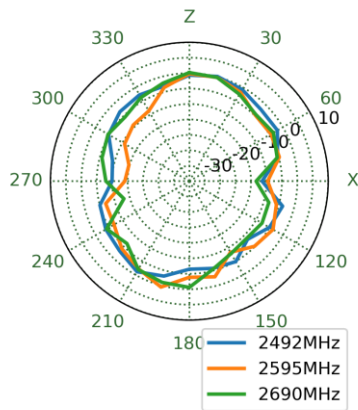

YZ Plane

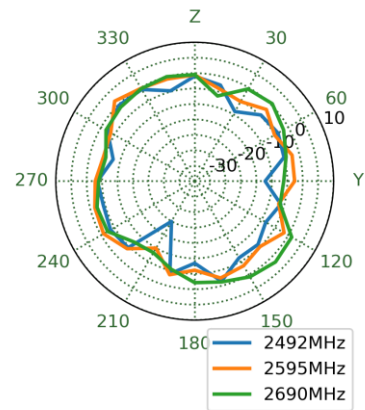

3550MHz

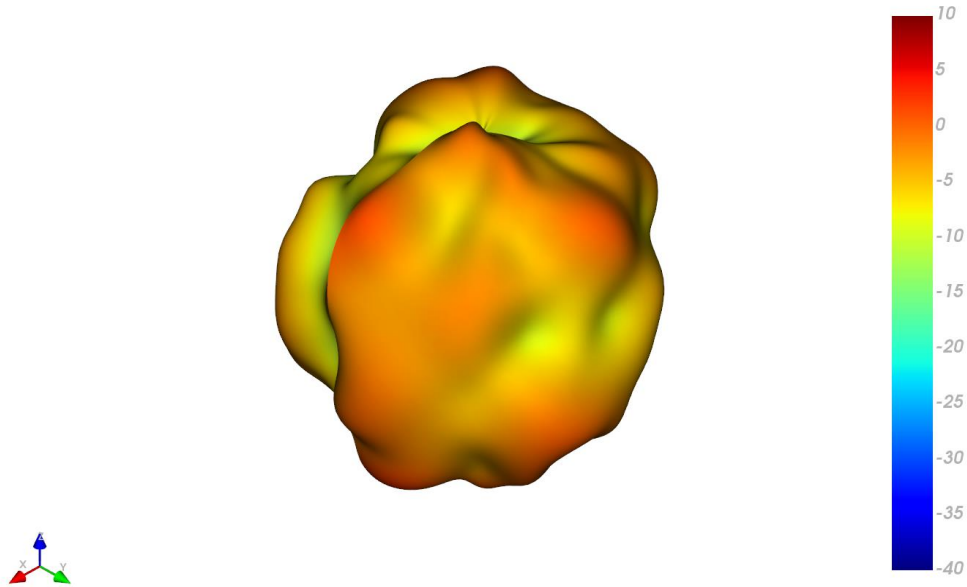

XY Plane

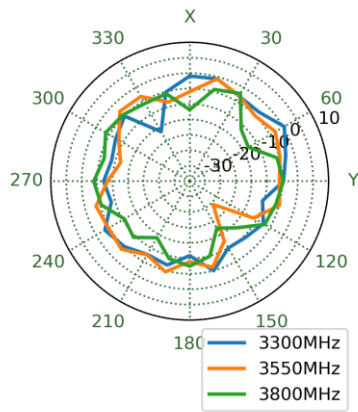

XZ Plane

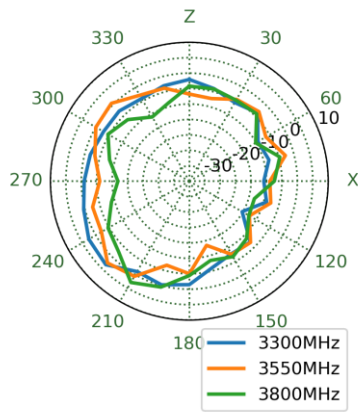

YZ Plane

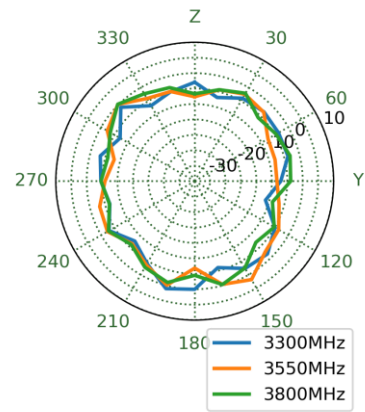

5.4 5G/4G MIMO 3 3D and 2D Radiation Patterns

652MHz

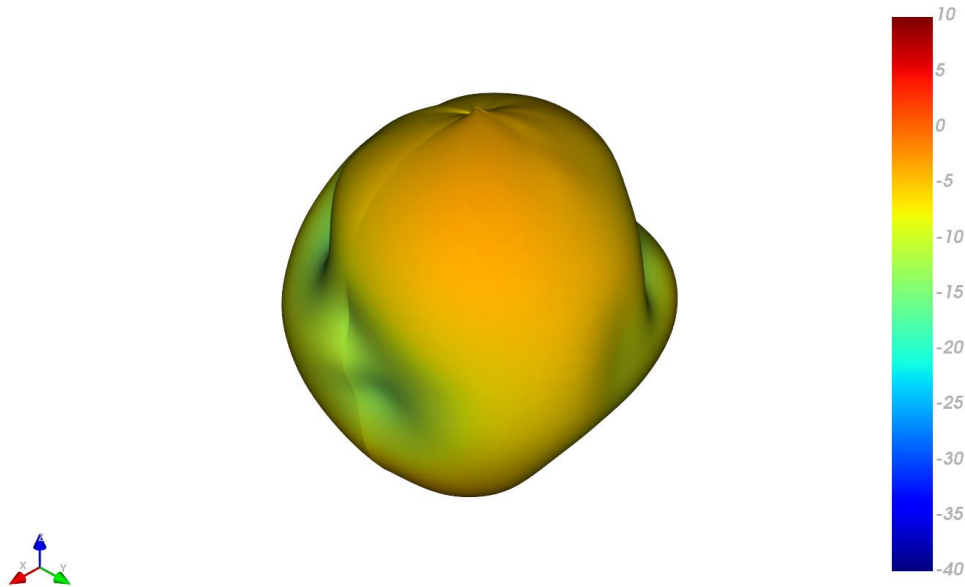

XY Plane

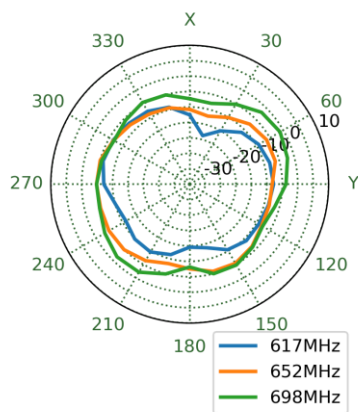

XZ Plane

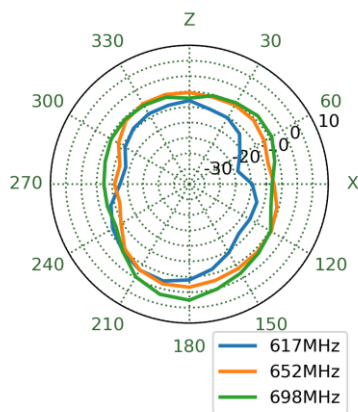

YZ Plane

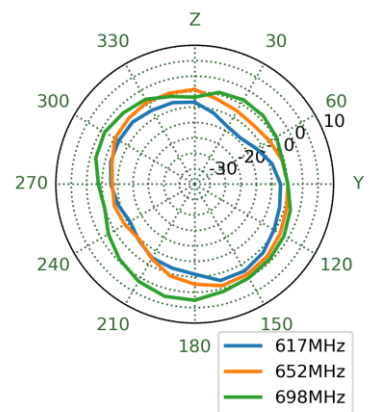

751MHz

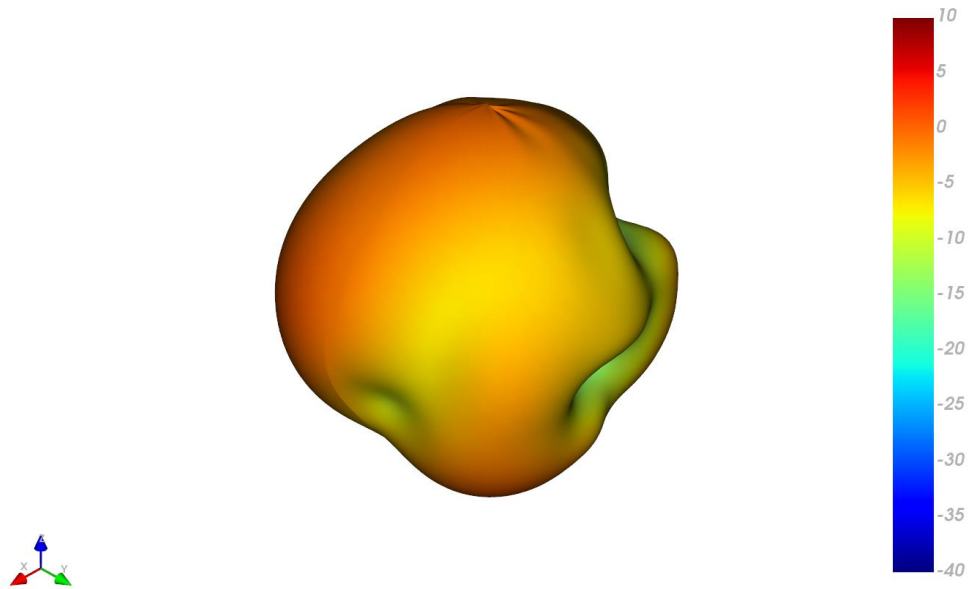

XY Plane

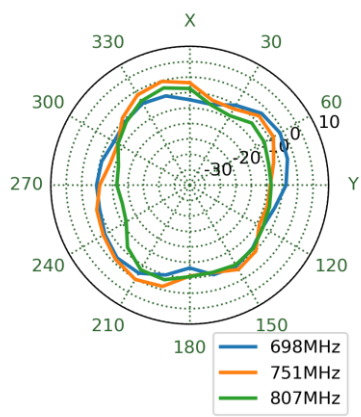

XZ Plane

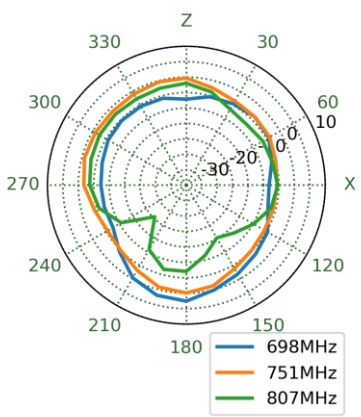

YZ Plane

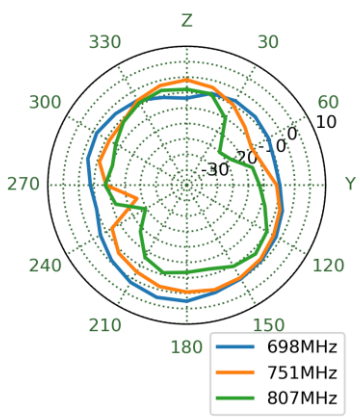

890MHz

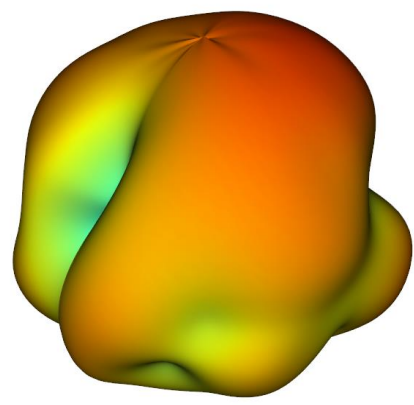

XY Plane

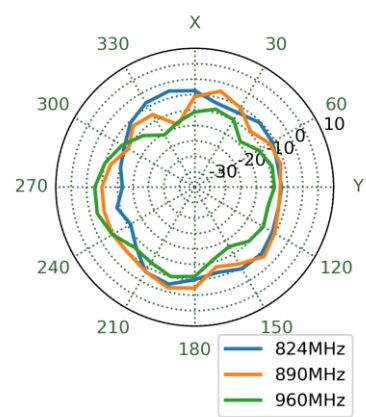

XZ Plane

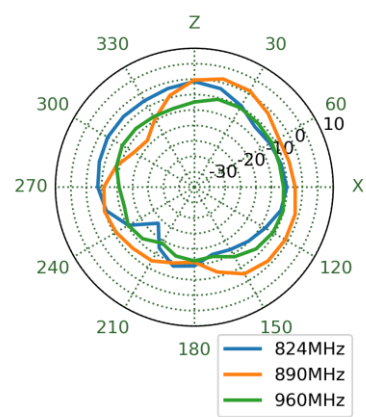

YZ Plane

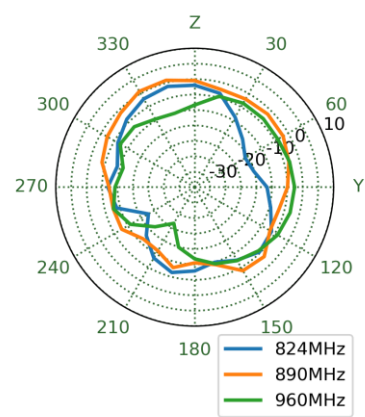

1470MHz

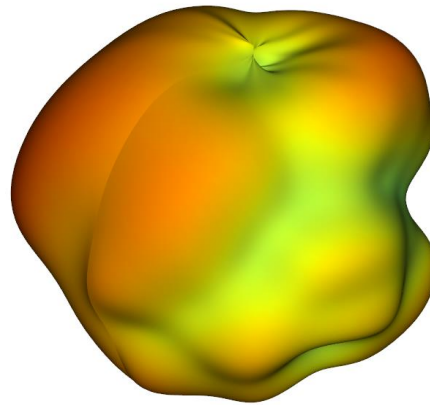

XY Plane

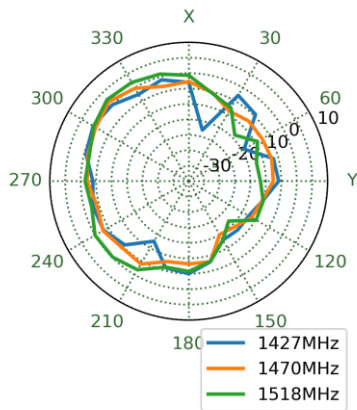

XZ Plane

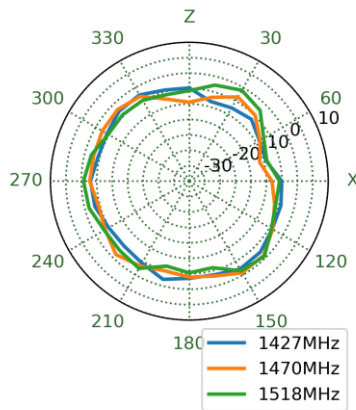

YZ Plane

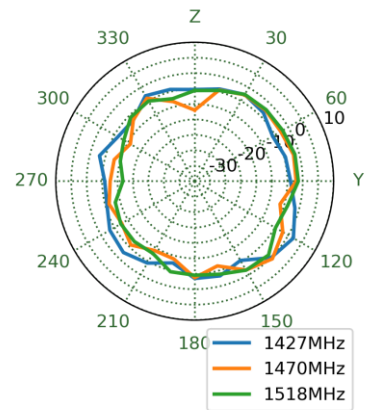

1805MHz

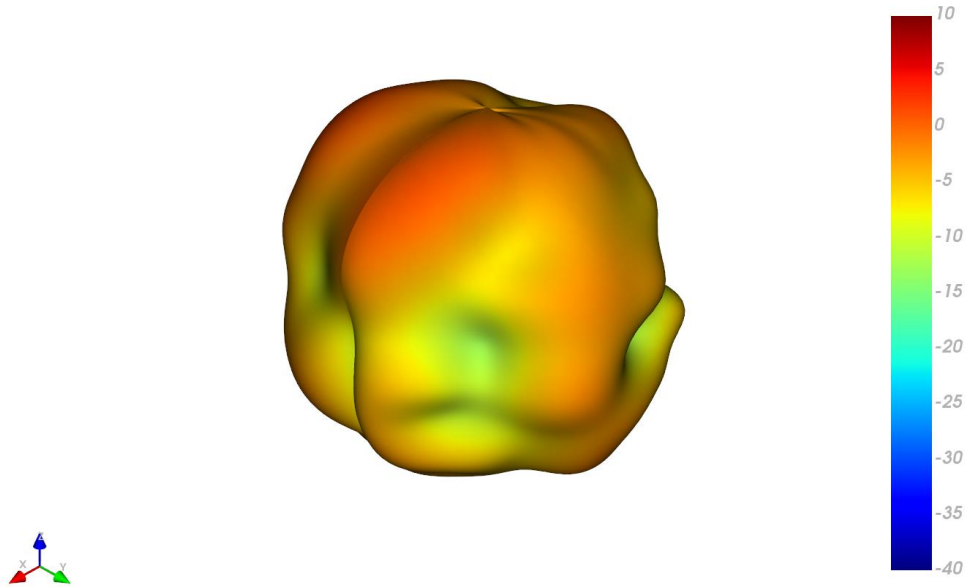

XY Plane

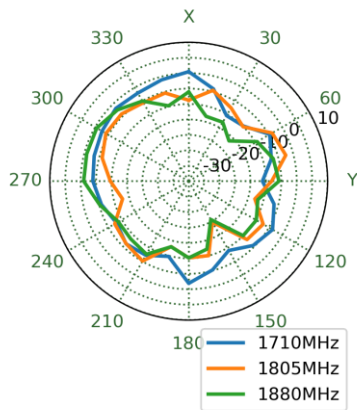

XZ Plane

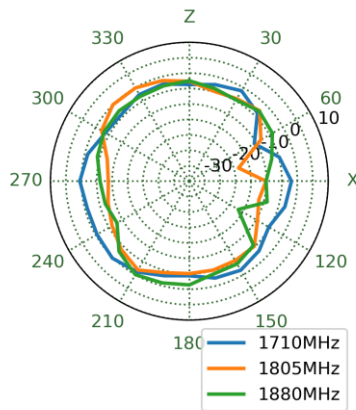

YZ Plane

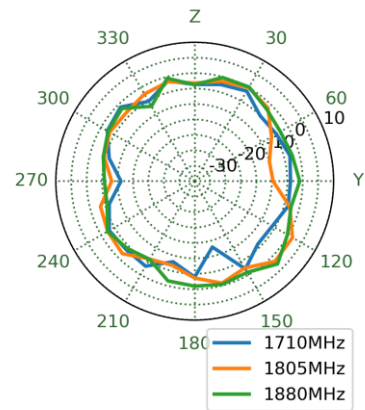

1920MHz

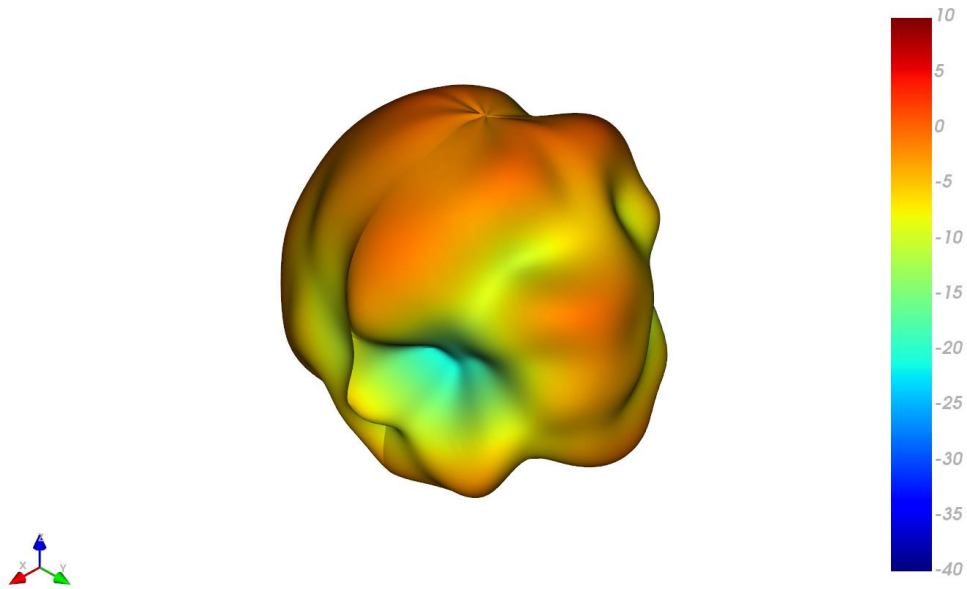

XY Plane

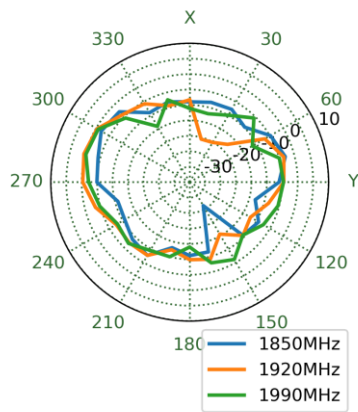

XZ Plane

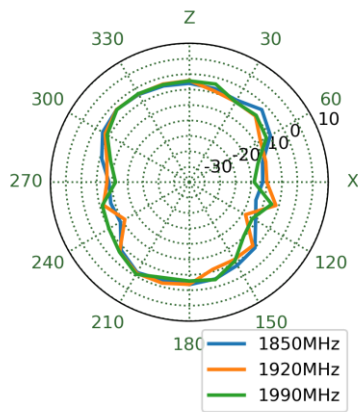

YZ Plane

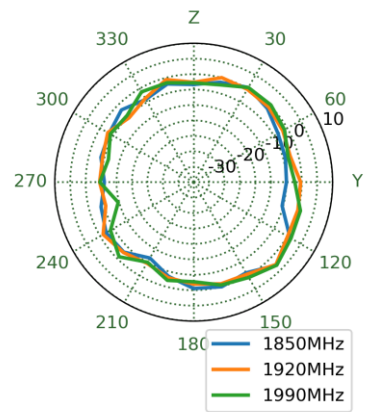

1990MHz

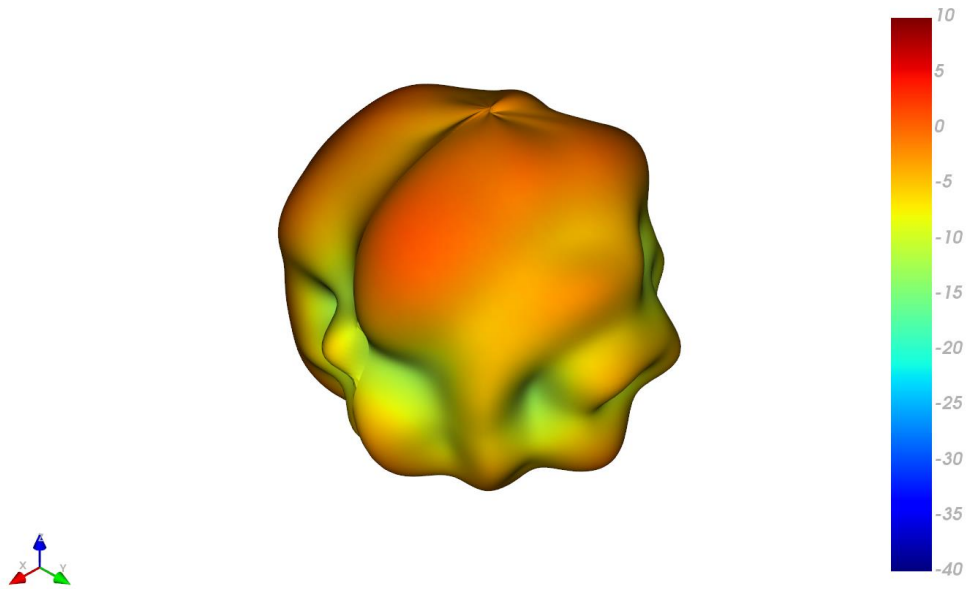

XY Plane

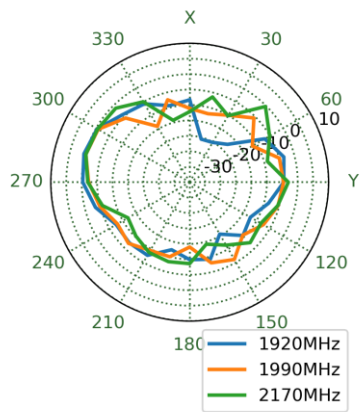

XZ Plane

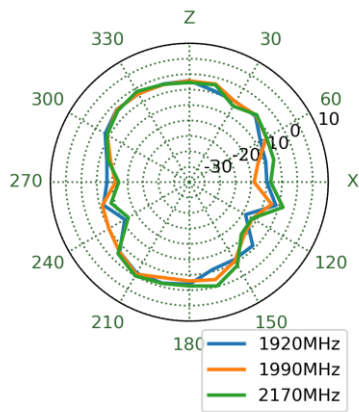

YZ Plane

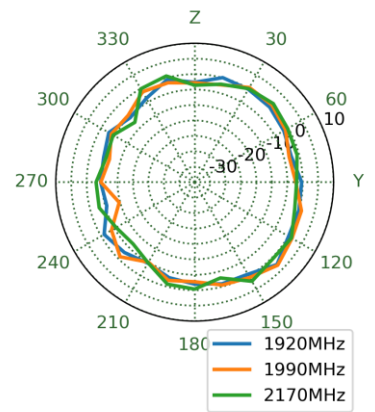

2595MHz

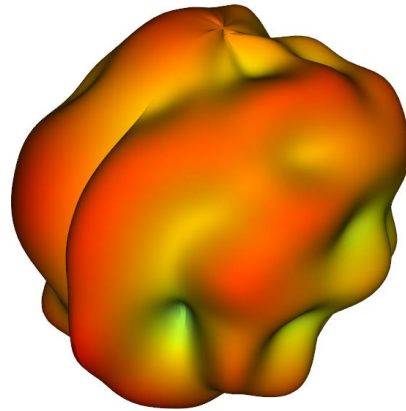

XY Plane

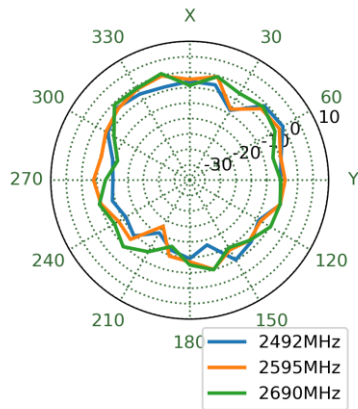

XZ Plane

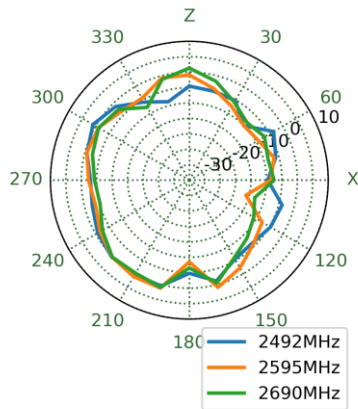

YZ Plane

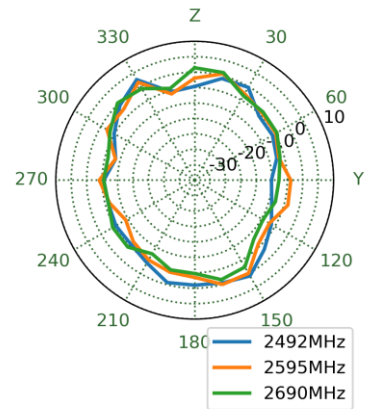

3550MHz

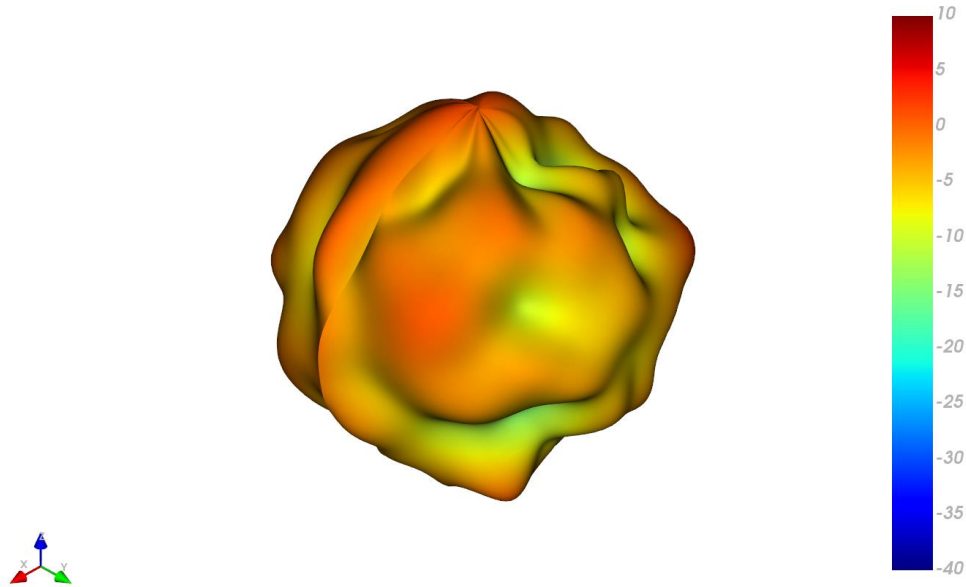

XY Plane

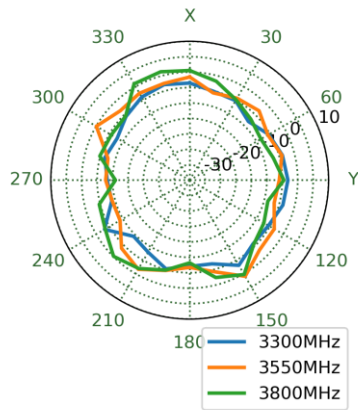

XZ Plane

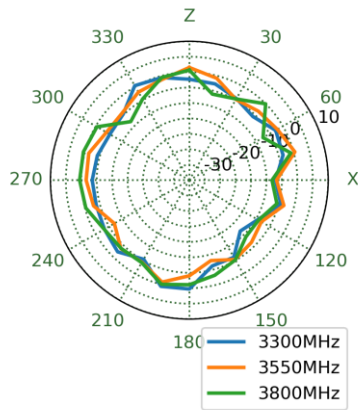

YZ Plane

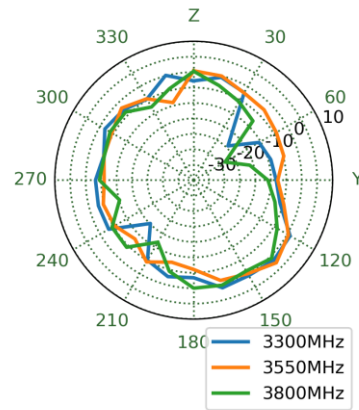

5.5 5G/4G MIMO 4 3D and 2D Radiation Patterns

652MHz

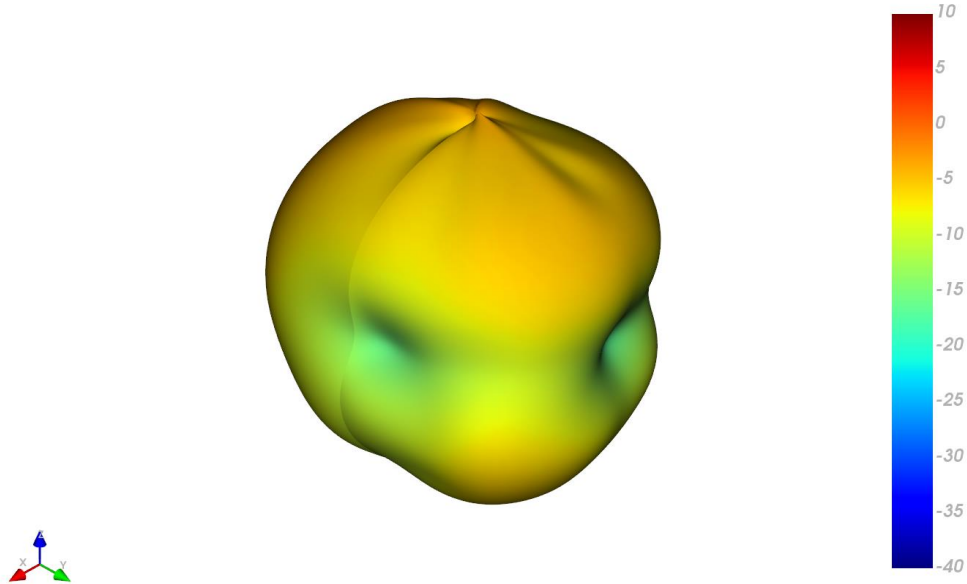

XY Plane

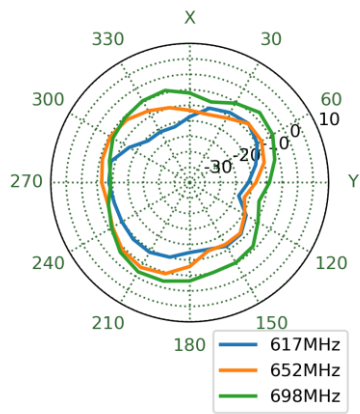

XZ Plane

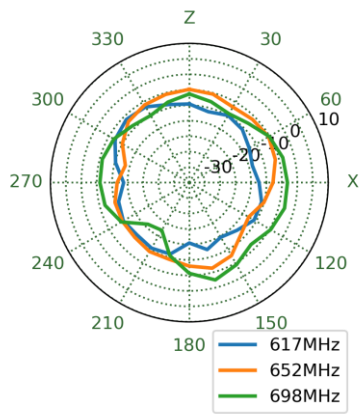

YZ Plane

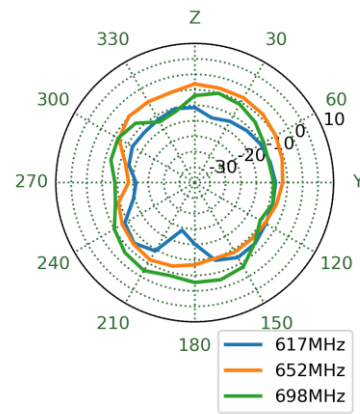

751MHz

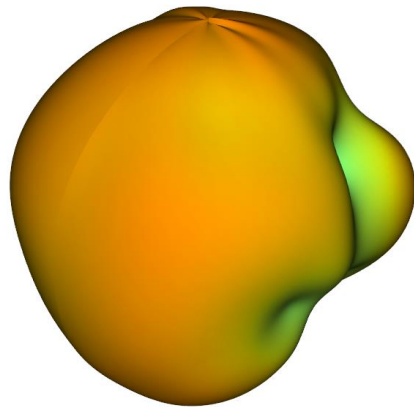

XY Plane XZ Plane YZ Plane

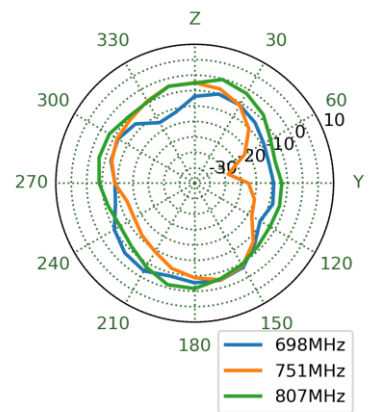
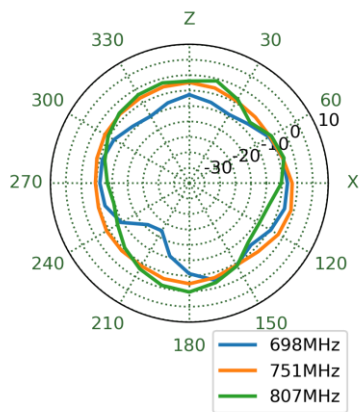
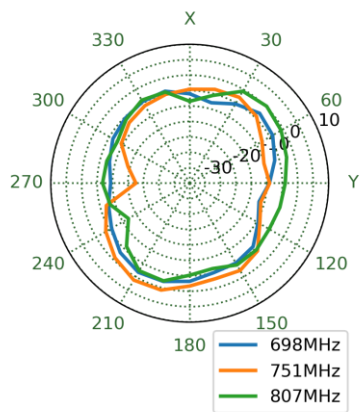

890MHz

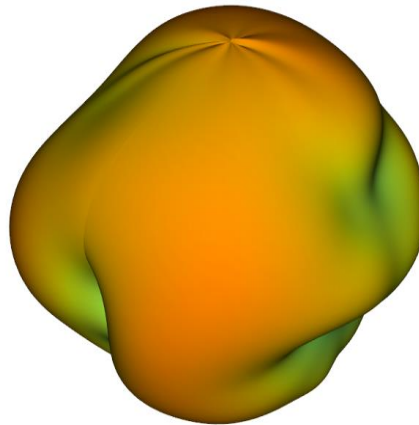

XY Plane

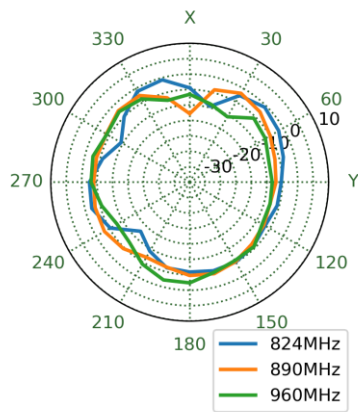

XZ Plane

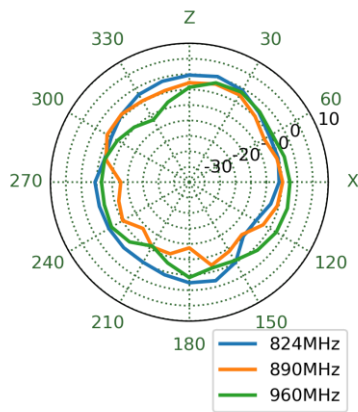

YZ Plane

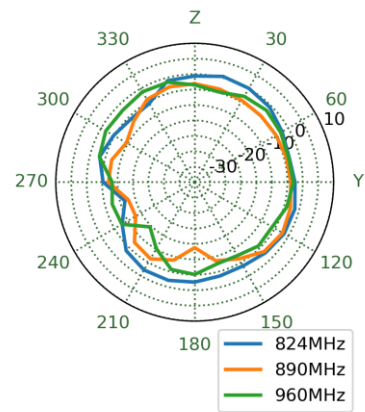

1470MHz

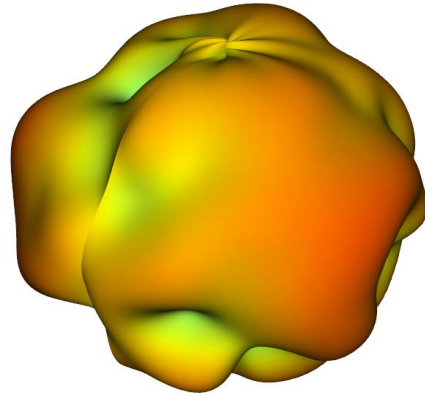

XY Plane

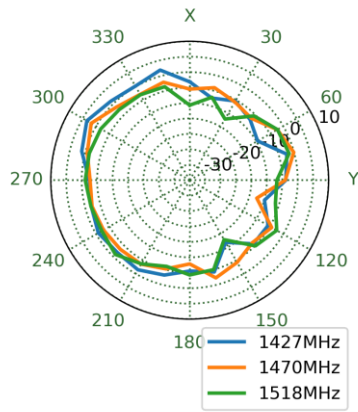

XZ Plane

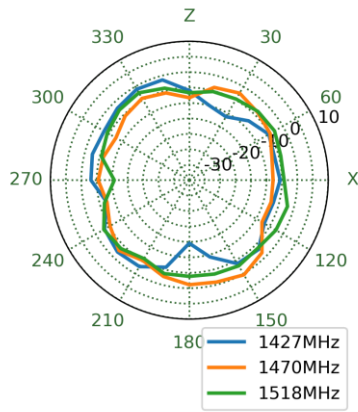

YZ Plane

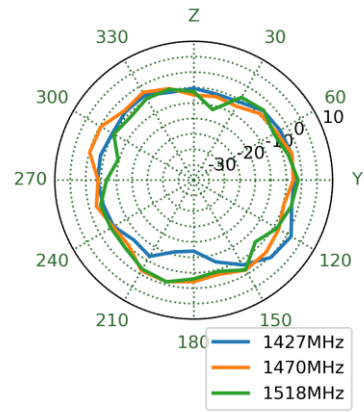

1805MHz

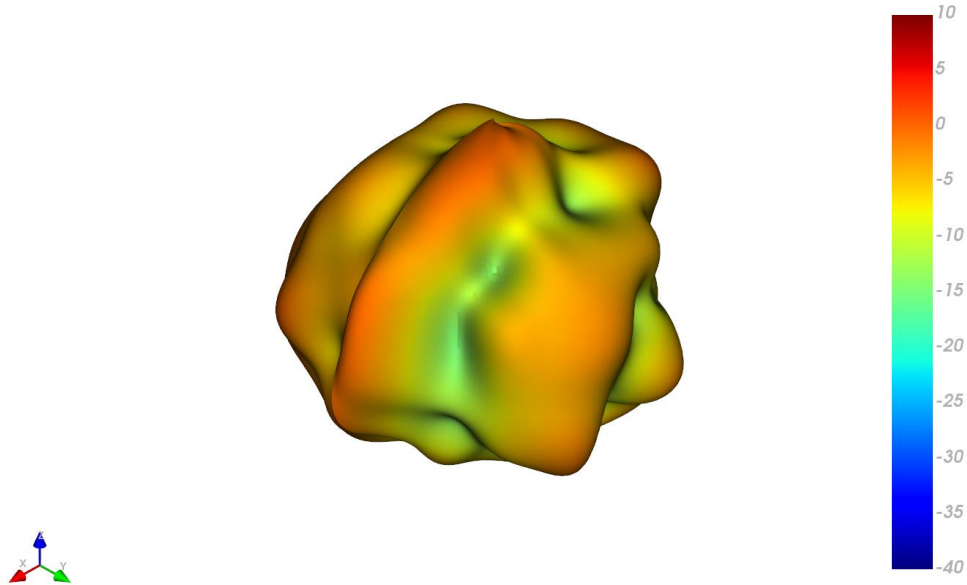

XY Plane

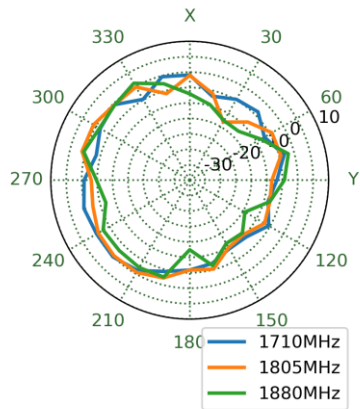

XZ Plane

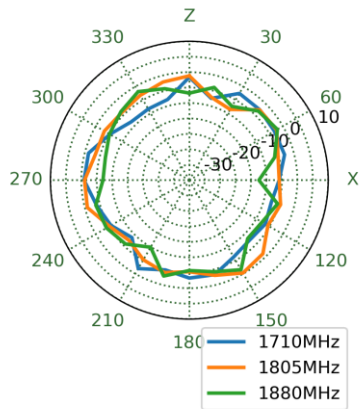

YZ Plane

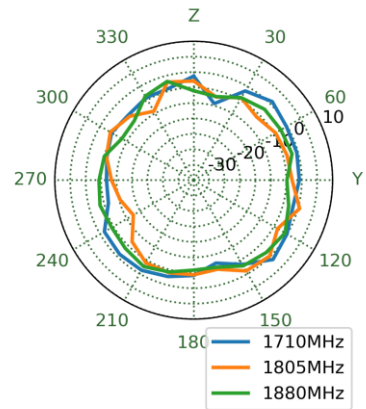

1920MHz

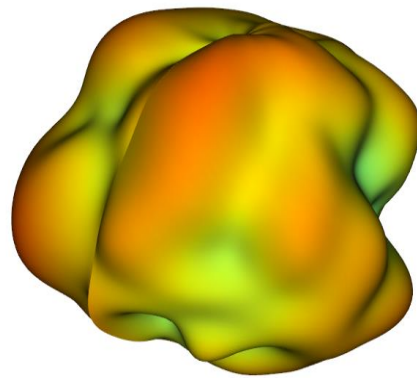

XY Plane

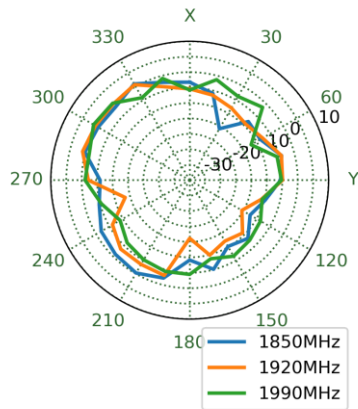

XZ Plane

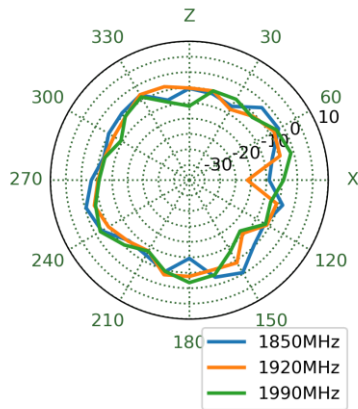

YZ Plane

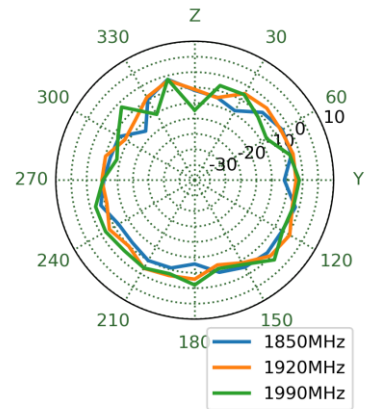

1990MHz

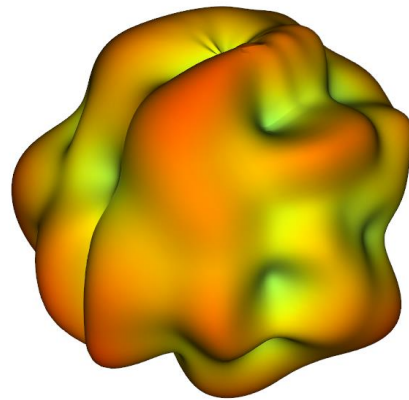

XY Plane

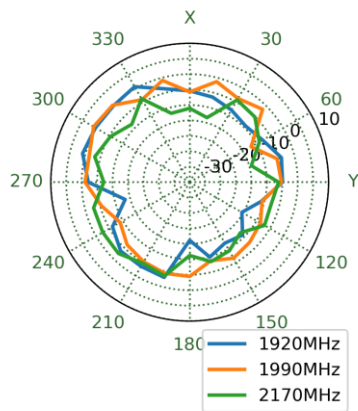

XZ Plane

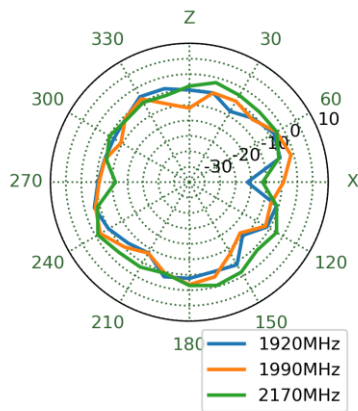

YZ Plane

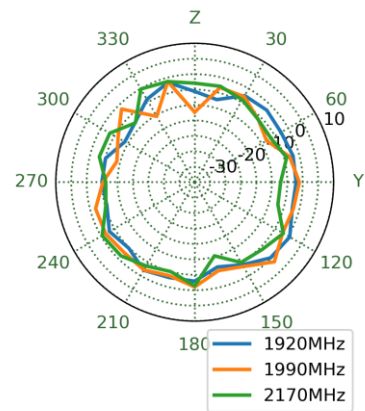

2595MHz

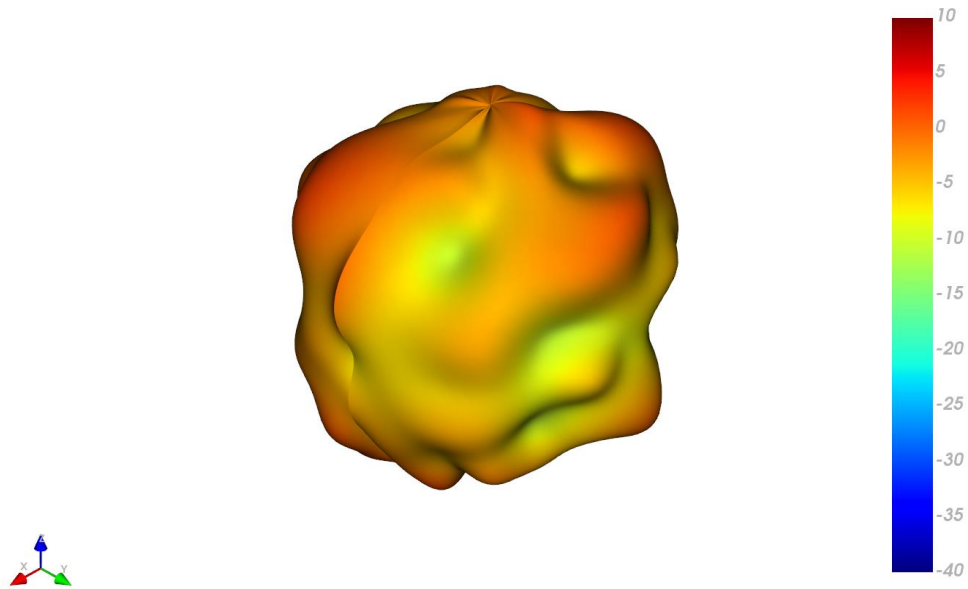

XY Plane

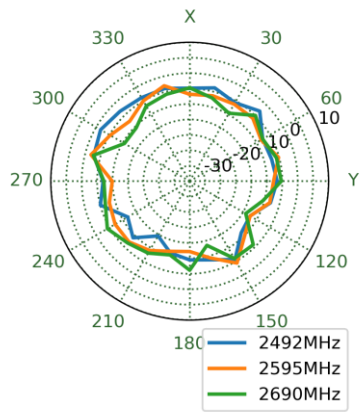

XZ Plane

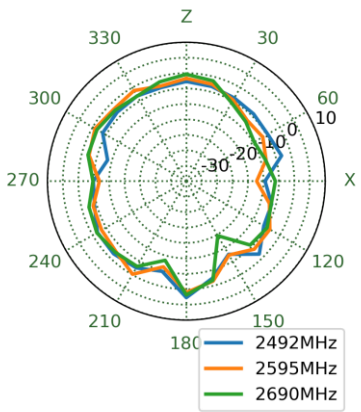

YZ Plane

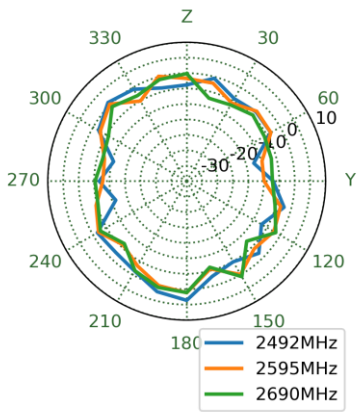

3550MHz

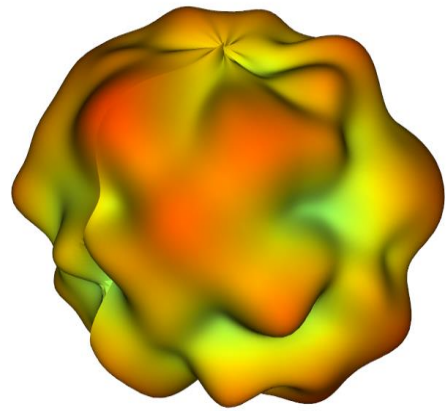

XY Plane XZ Plane YZ Plane

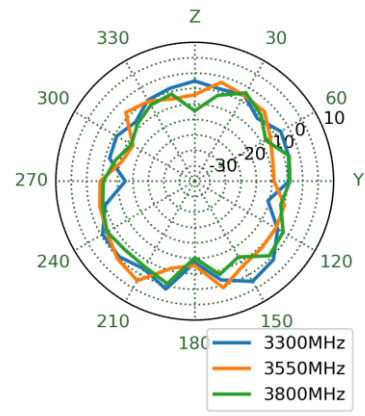
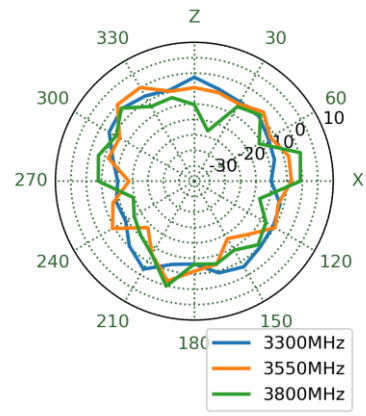
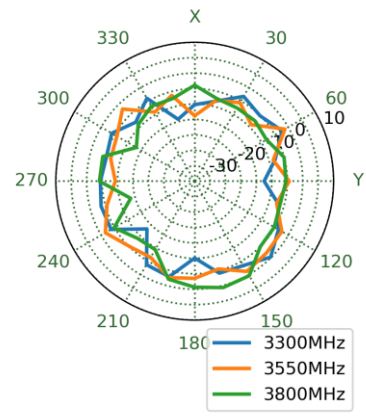

5.6 Wi-Fi MIMO 1 3D and 2D Radiation Patterns

2450MHz

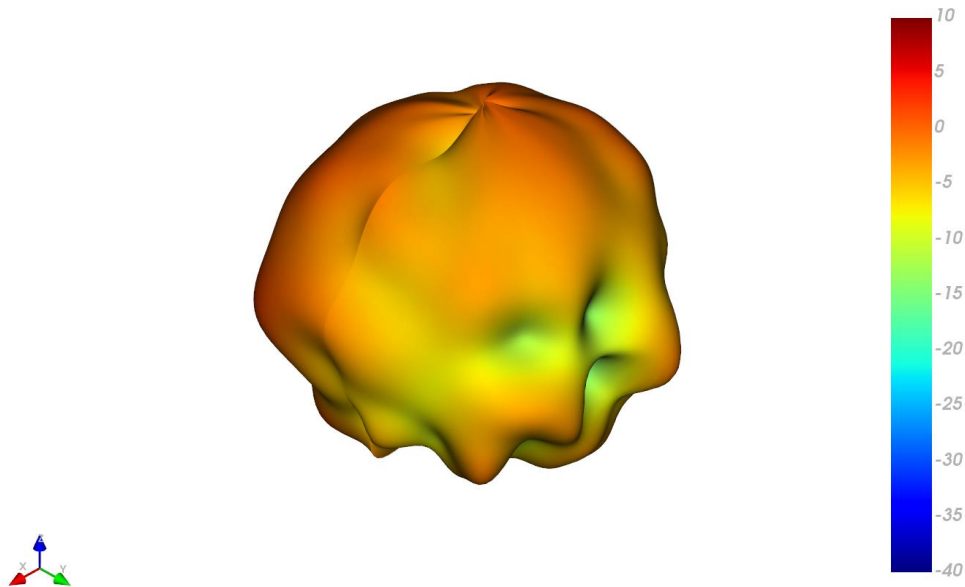

XY Plane XZ Plane YZ Plane

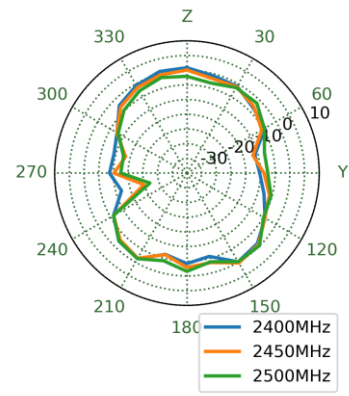
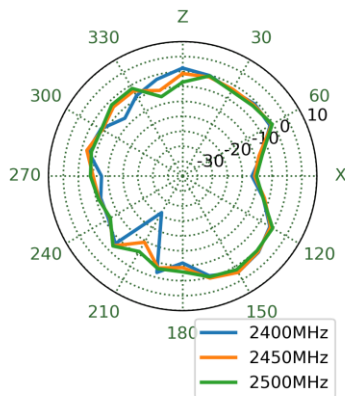
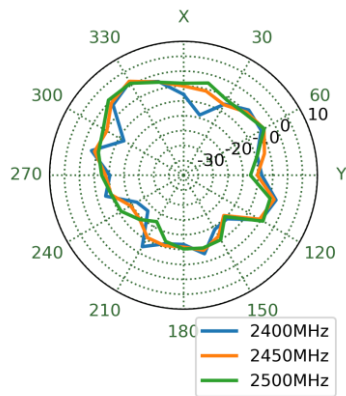

5550MHz

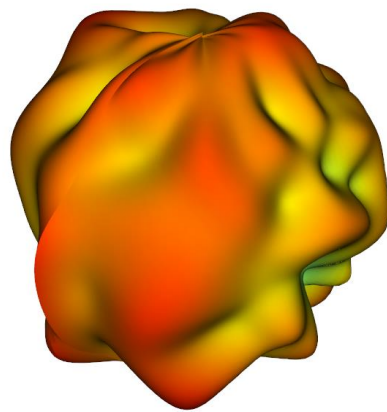

XY Plane XZ Plane YZ Plane

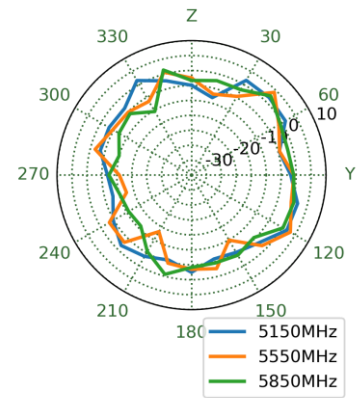
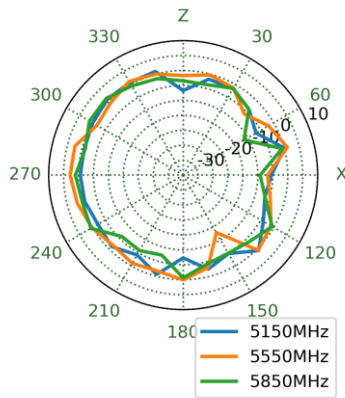
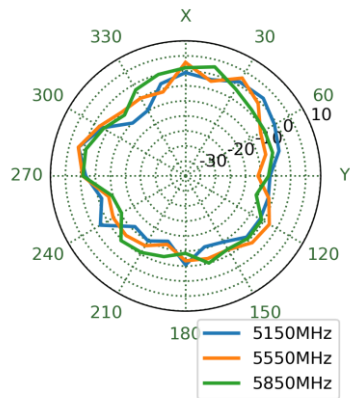

6475MHz

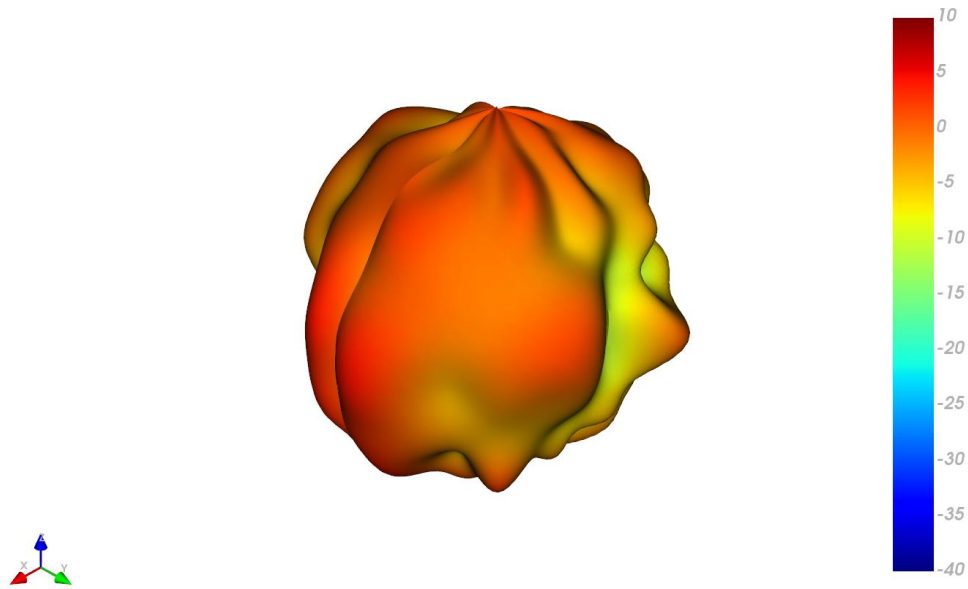

XY Plane

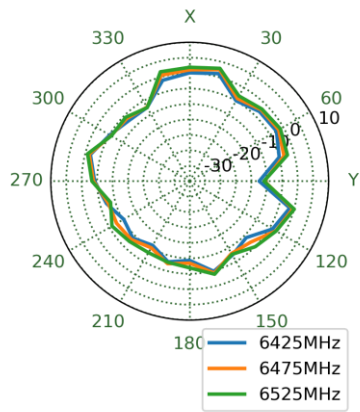

XZ Plane

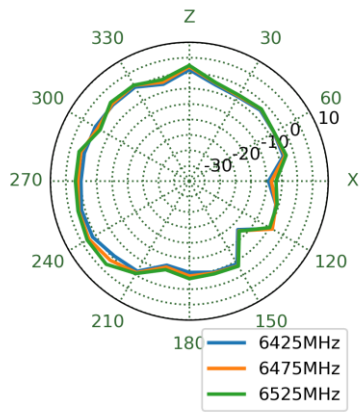

YZ Plane

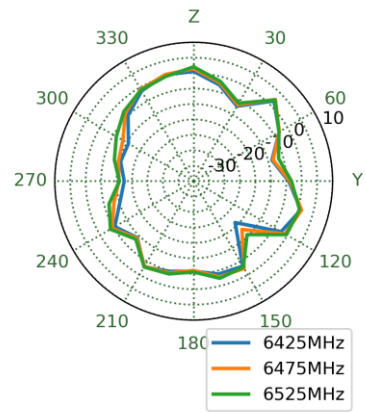

7000MHz

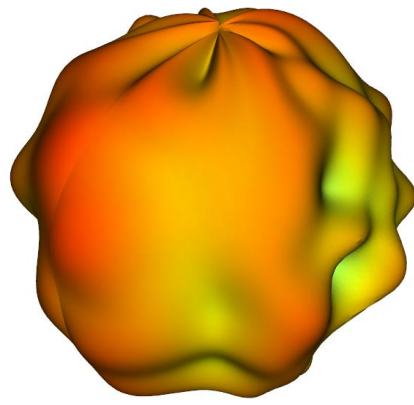

XY Plane XZ Plane YZ Plane

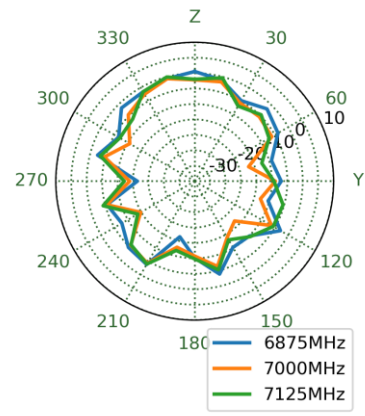
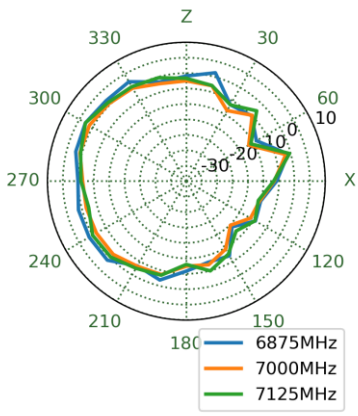
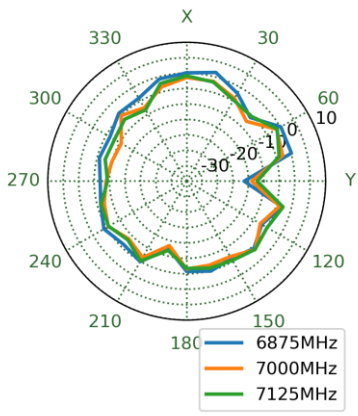

5.7 Wi-Fi MIMO 2 3D and 2D Radiation Patterns

2450MHz

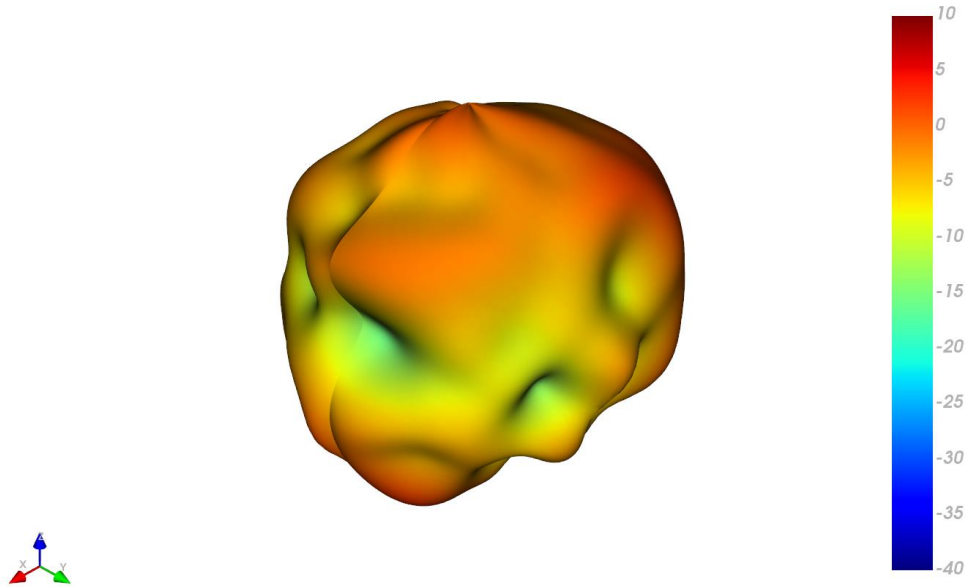

XY Plane

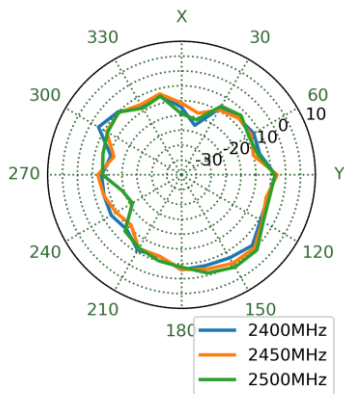

XZ Plane

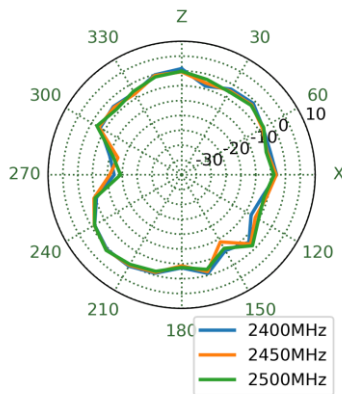

YZ Plane

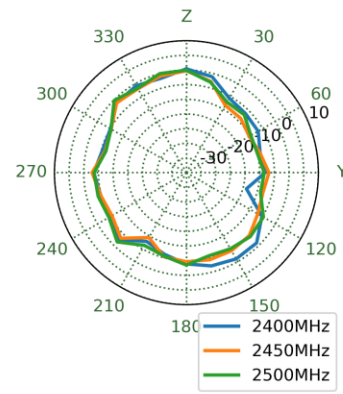

5550MHz

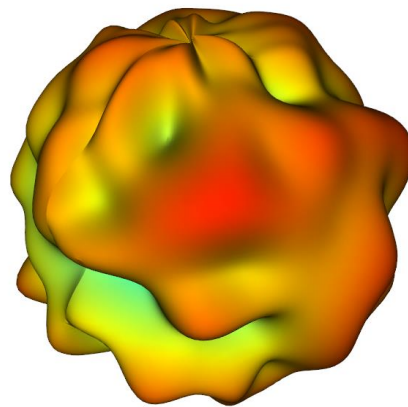

XY Plane

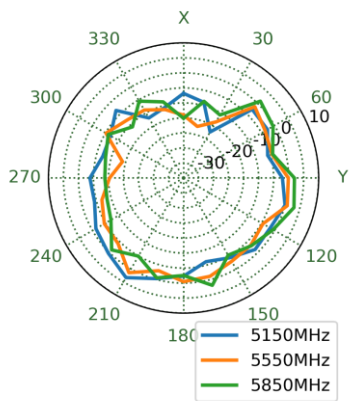

XZ Plane

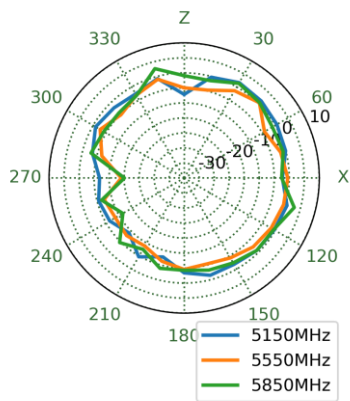

YZ Plane

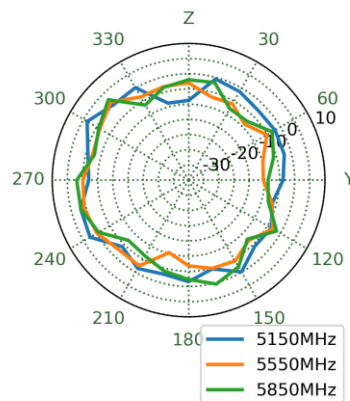

6475MHz

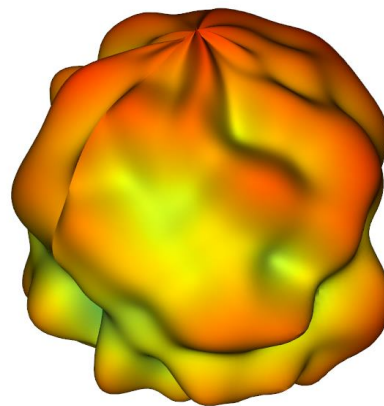

XY Plane XZ Plane YZ Plane

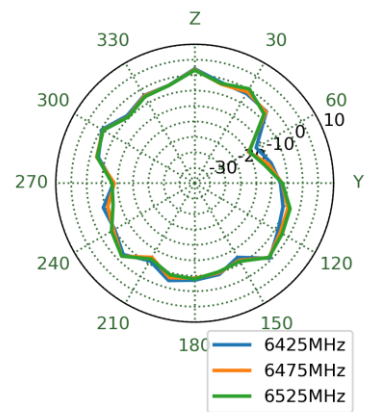
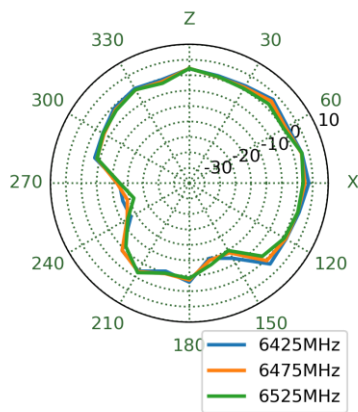
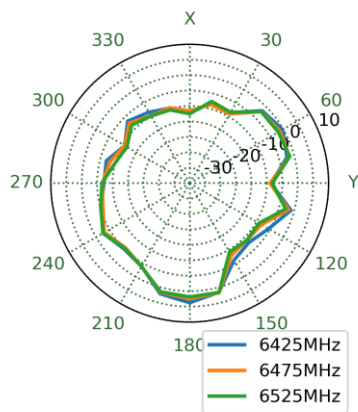

7000MHz

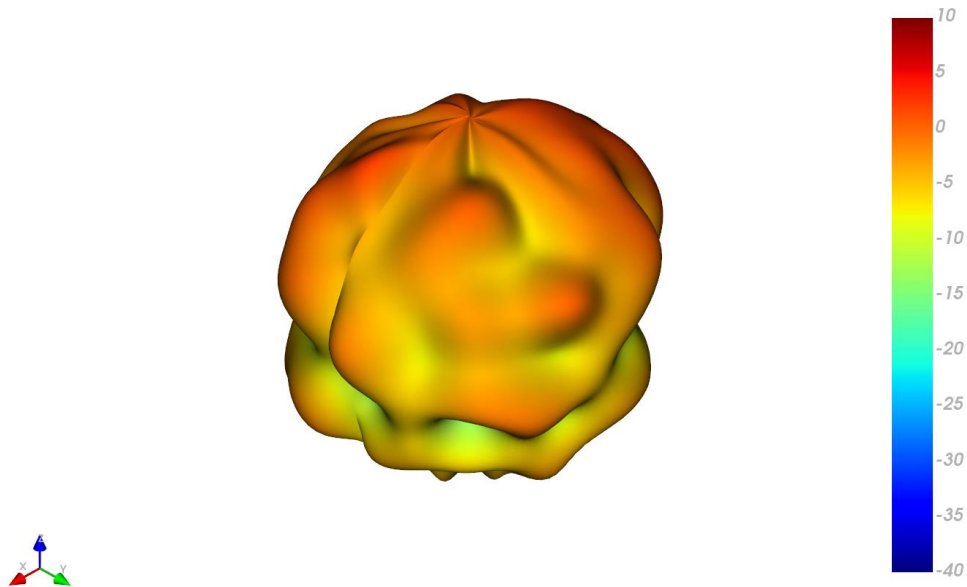

XY Plane

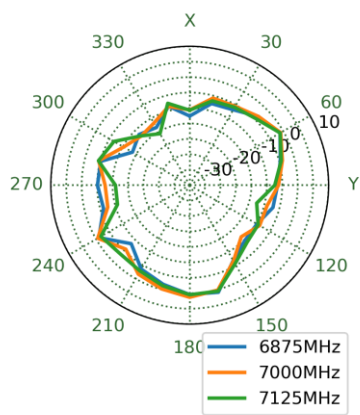

XZ Plane

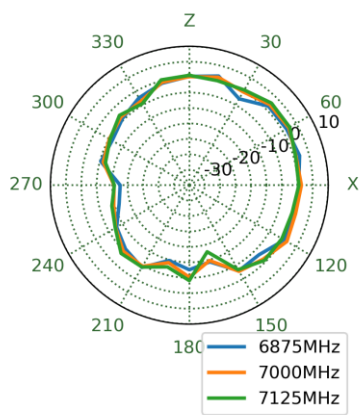

YZ Plane

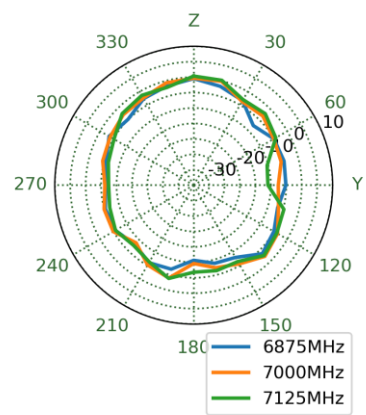

5.8 Wi-Fi MIMO 3 3D and 2D Radiation Patterns

2450MHz

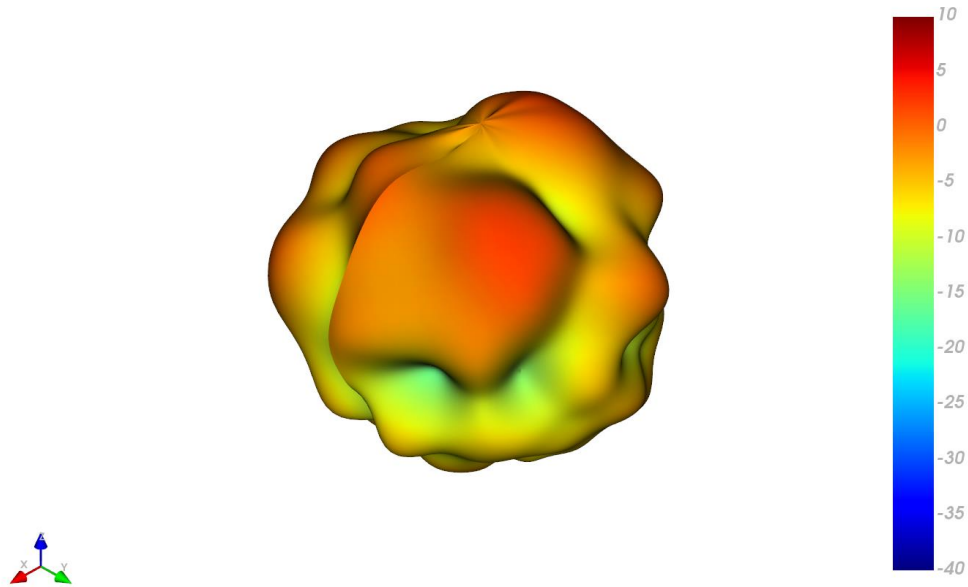

XY Plane

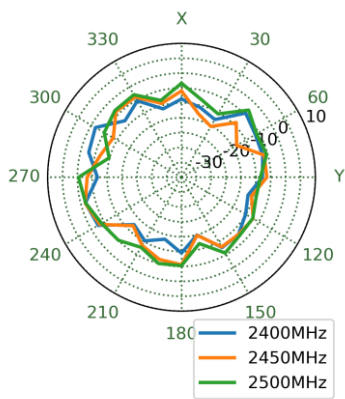

XZ Plane

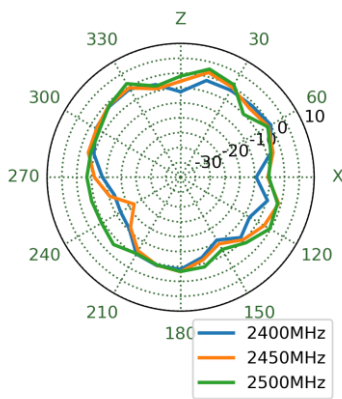

YZ Plane

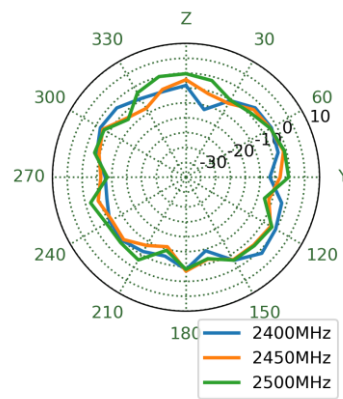

5550MHz

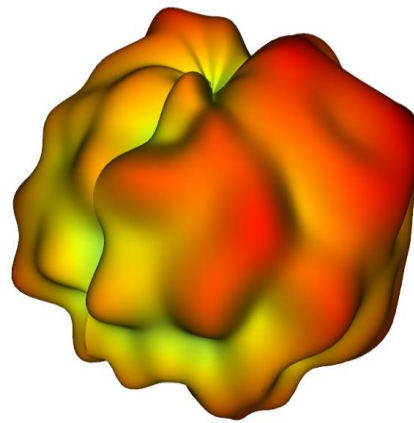

XY Plane

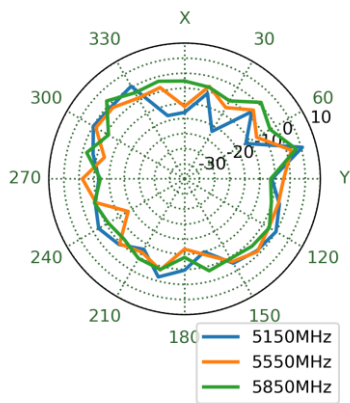

XZ Plane

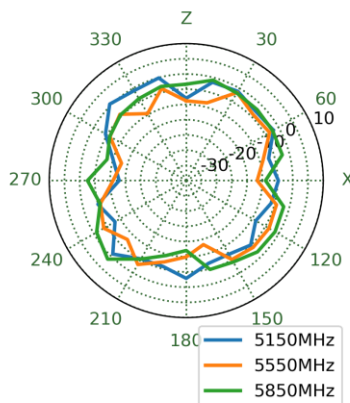

YZ Plane

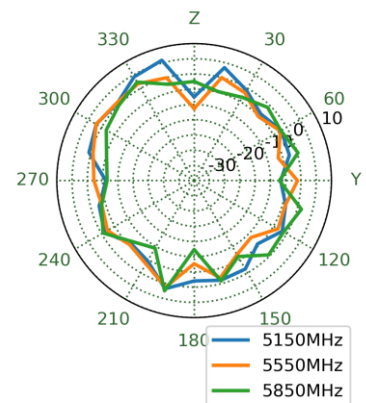

6475MHz

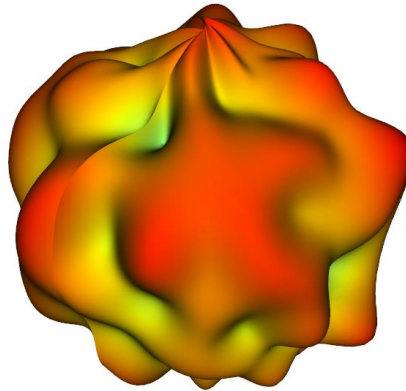

XY Plane

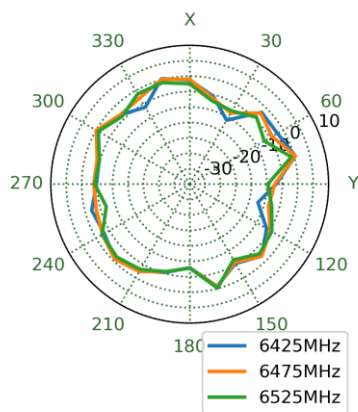

XZ Plane

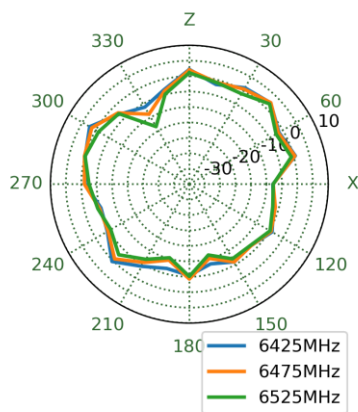

YZ Plane

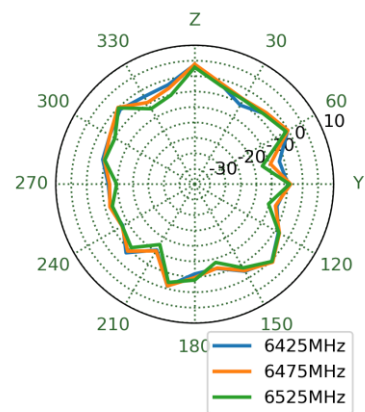

7000MHz

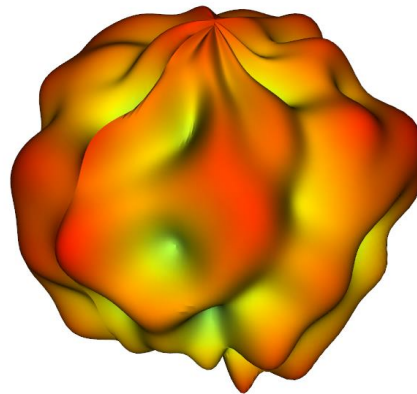

XY Plane

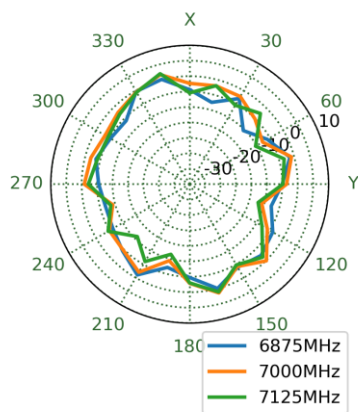

XZ Plane

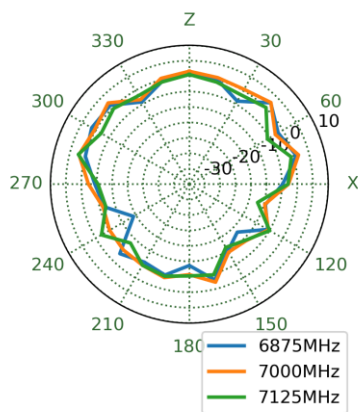

YZ Plane

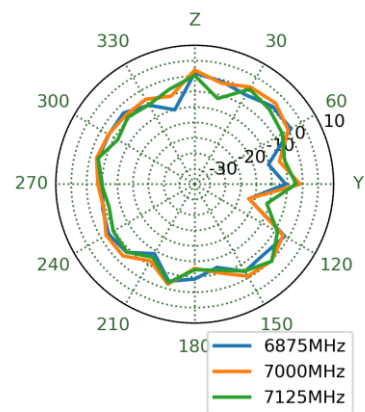

5.9 Wi-Fi MIMO 4 3D and 2D Radiation Patterns

2450MHz

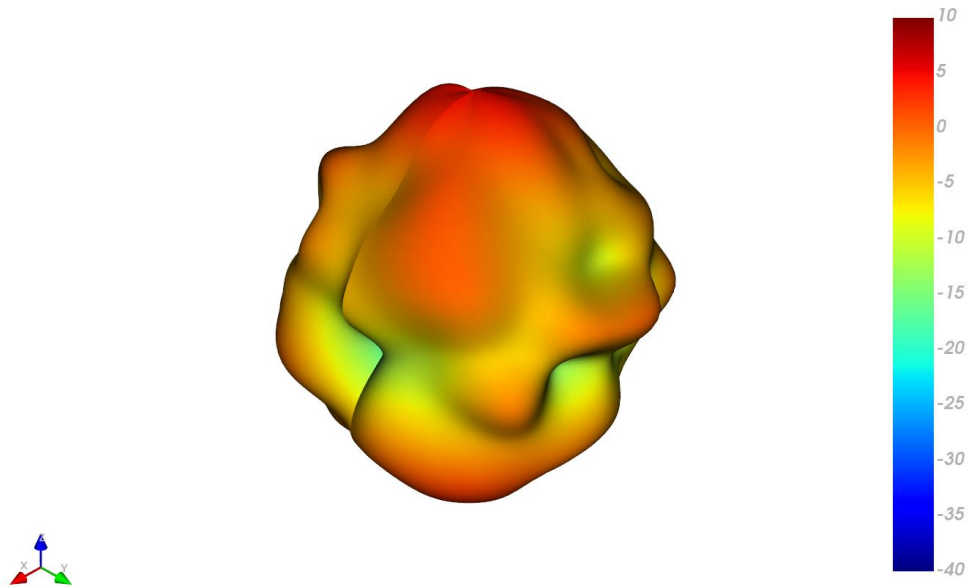

XY Plane

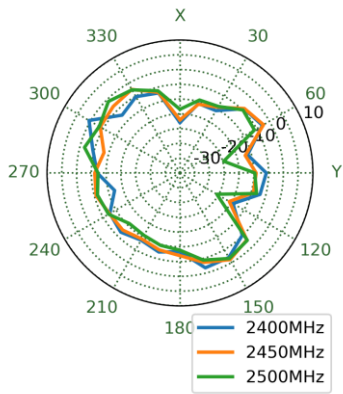

XZ Plane

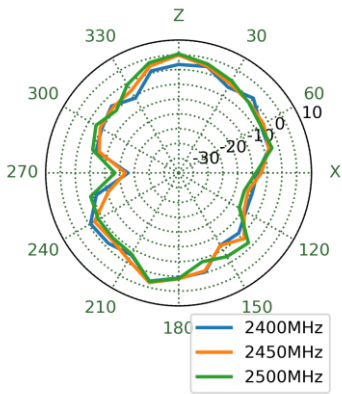

YZ Plane

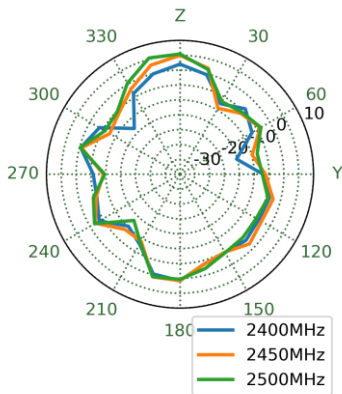

5550MHz

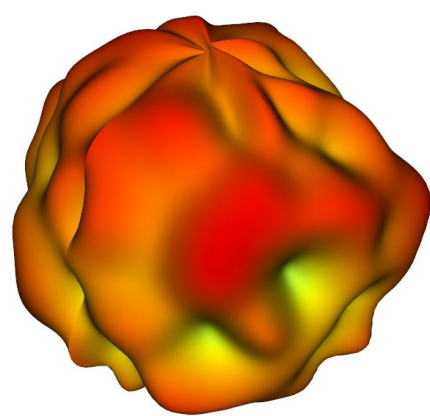

XY Plane

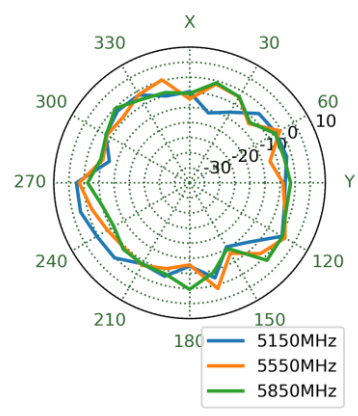

XZ Plane

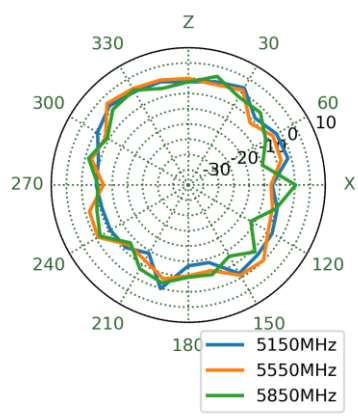

YZ Plane

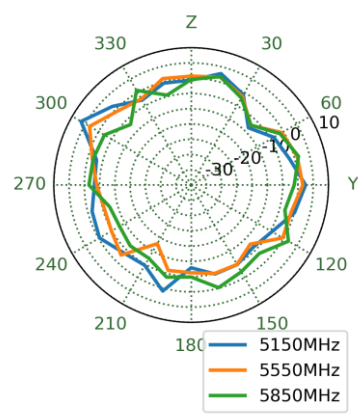

6475MHz

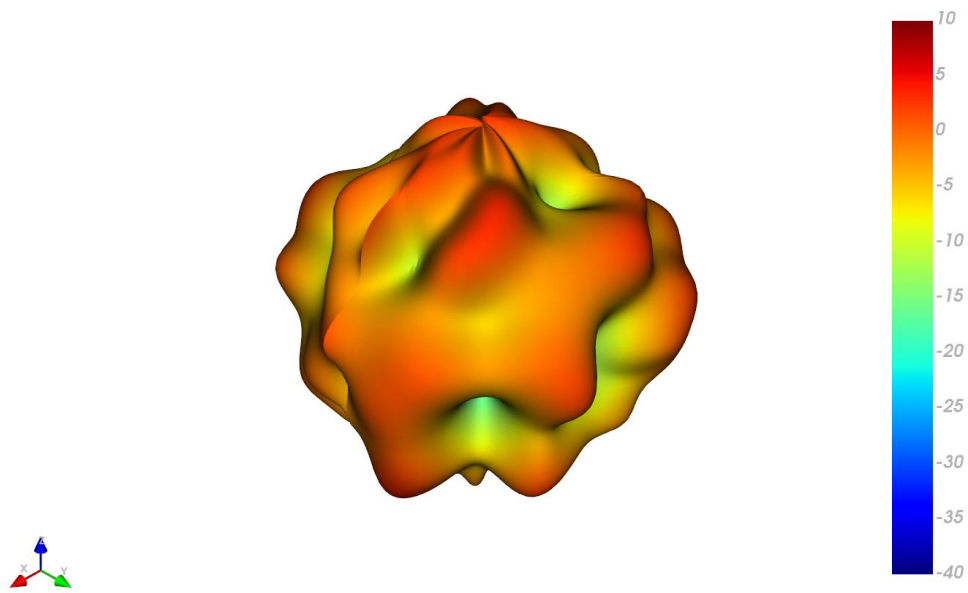

XY Plane

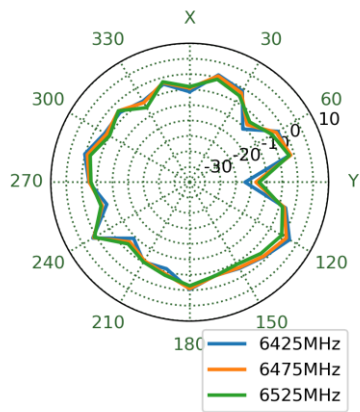

XZ Plane

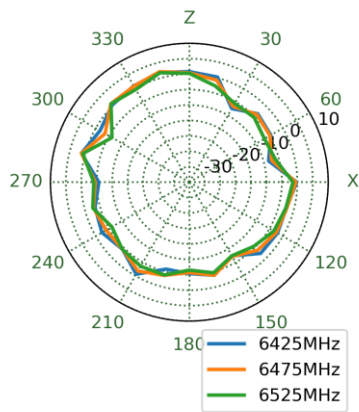

YZ Plane

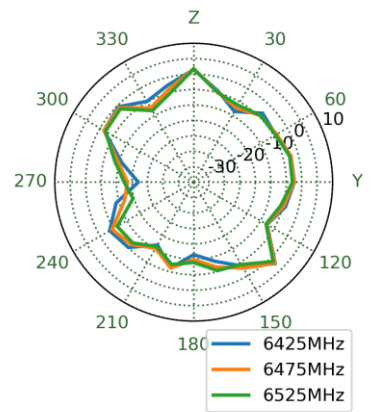

7000MHz

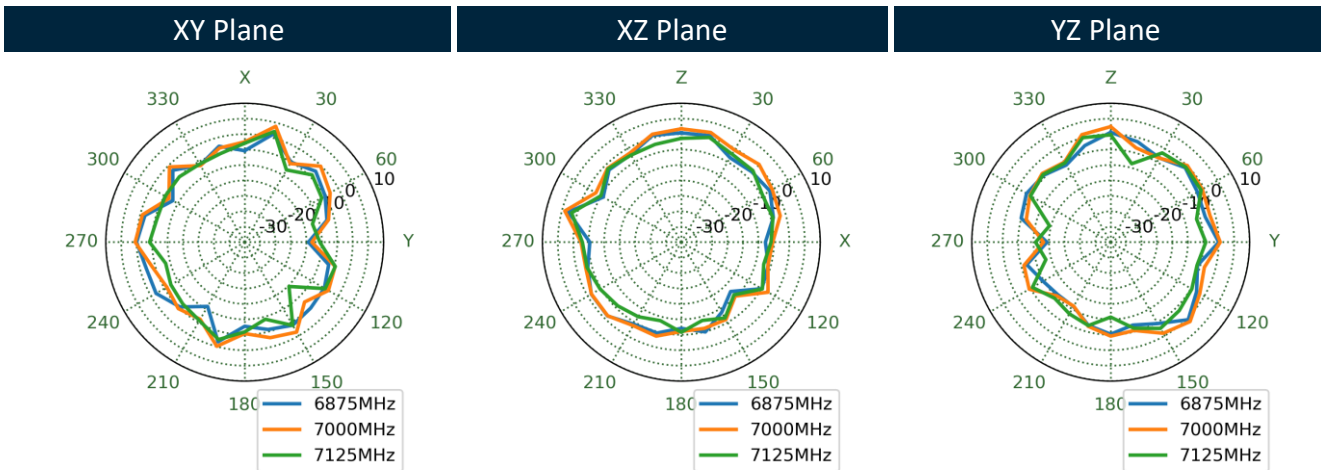
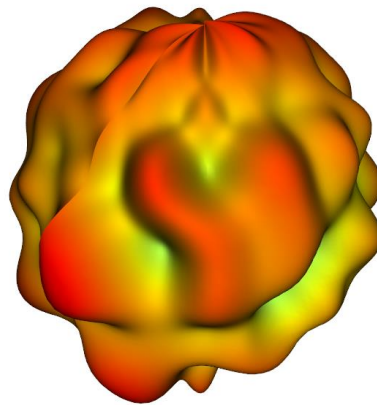

6. Mechanical Drawing (Units: mm)

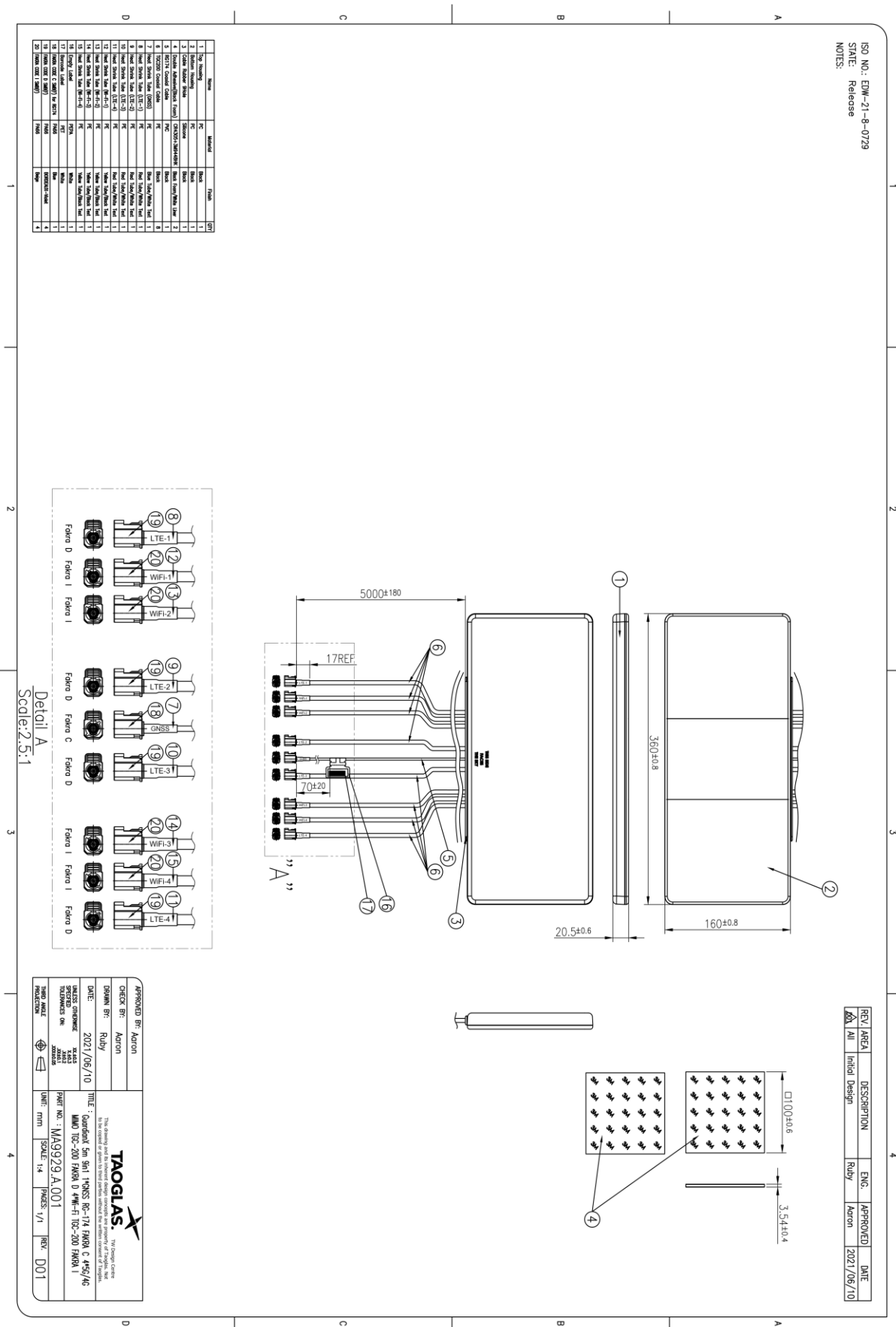

7. Packaging

1pc MA9929.A.001 Per PE Bag
 Bag Dimensions – 364*524mm
 Weight – 1.068Kg

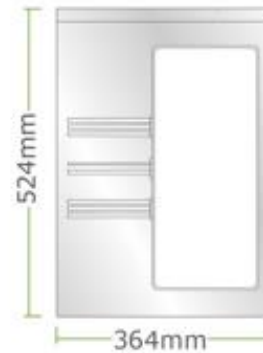

10pcs MA9929.A.001 Per Carton
 Carton Dimensions – 430*380*280mm
 Weight – 11.6Kg

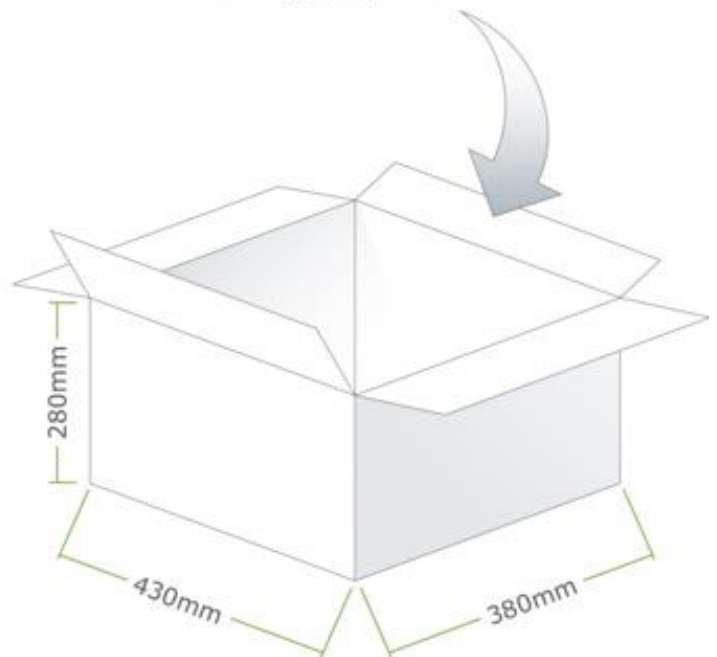

Pallet Dimensions:
 1200mm * 1000mm 1280mm
 24 Cartons Per Pallet
 6 Cartons Per Layer, 4 Layers

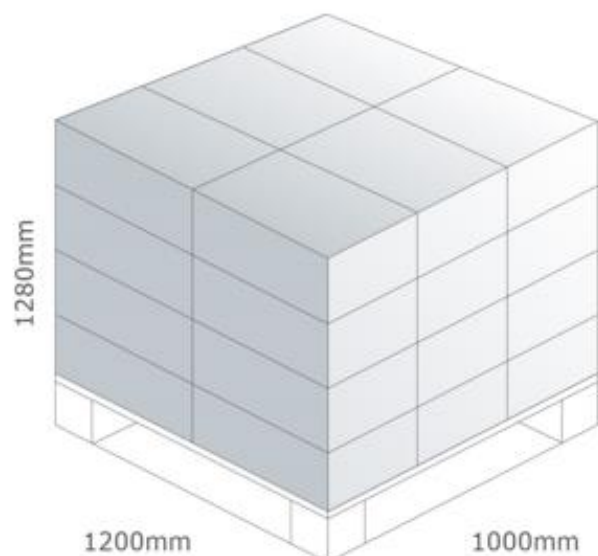

Changelog for the datasheet

SPE-21-8-069– MA9929.A.001

Revision: A (Original First Release)

| | |
|---------|------------------------------|
| Date: | 2021-08-19 |
| Notes: | Custom Datasheet New Release |
| Author: | Gary West |

Previous Revisions

| | |
|--|--|
| | |
| | |
| | |
| | |



www.taoglas.com

