

Pressfit Indicator Lights for 1/2 Dia. Mounting Hole

32/35 SERIES

- PRESSFIT INDICATOR LIGHTS
- NEON, LED & INCANDESCENT
- 2 TO 600 DESIGN VOLTS
- 3/16" TAB TERMINALS
- VARIETY OF LENS COLORS
- UL LISTED • UL FILE E20356

Overview

The 32/35 Series Indicators feature a wide variety of lenses, colors, voltage & bezel variations. Indicators quickly pressfit into a 0.500" to 0.510" mounting hole with recommended panel thickness range of 0.020" min. to 0.090" max. A speednut, part number **8700071674**, and Adapters for 0.514" to 0.519" are available.

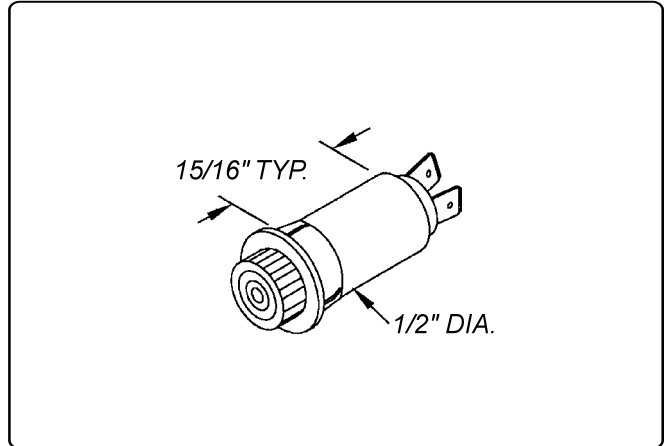

Specifications

Housing: white nylon. A black housing is available.

Bezel: nickel plated brass. A black anodized bezel is available.

Lens: polycarbonate.

Incandescent AC or DC voltage options: 6, 14 and 28 volts.

Neon AC or DC voltage options: 125, 250 and 600 volts. **Note:** high brightness green and blue neon lamps supplied in green and blue neon applications.

LED DC voltage options: 2, 6, 12, 24 volts.

LED AC voltage options: 125 volts.

Note: 125 volts AC units contain a bi-polar LED.

Terminals:

3/16" tabs: brass, (0.187" length x 0.020" thick). For LED units, a tin plated terminal denotes the anode (+). 1/4" or 1/8" brass tab terminals are available.

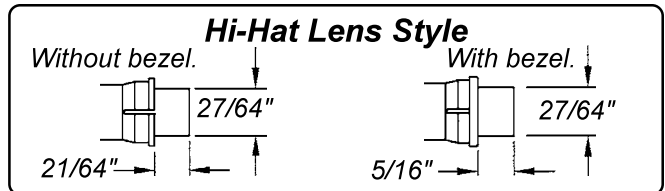
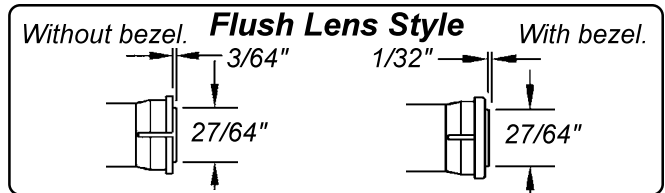
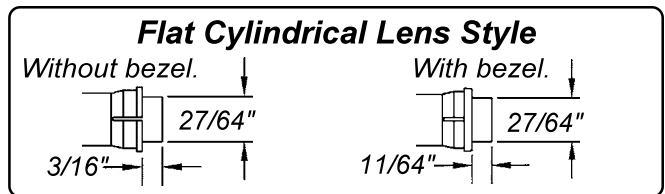

Pressfit Indicator Lights for 1/2 Dia. Mounting Hole

32/35 SERIES
Flat Cylindrical Lens
Without Bezel
Neon or
Incandescent

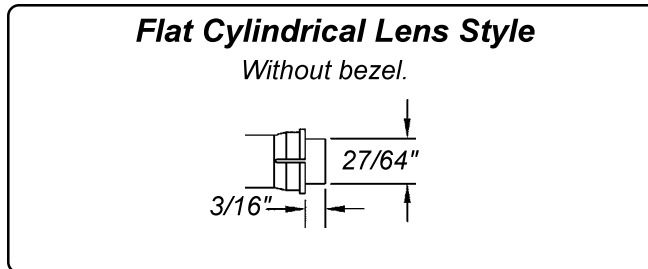

3/16" Tab Terminals
White Housing
6 to 250 Design Volts
PressFit Mounting

Part Number 3/16" Tab Terminals	Lens Color	Lamp Type	Design Volts	Design Watts or Amps	Life (hrs)
32-2111T	Red	Neon	125	1/3W	25,000
35-2111T	Red	Neon	250	1/3W	25,000
32G1-2111T	Red	Incandescent	6	.20A	5,000
32G3-2111T	Red	Incandescent	14	.10A	10,000
32G18-2111T	Red	Incandescent	28	.04A	7,000
32-2112T	Green	Neon	125	1/3W	25,000
35-2112T	Green	Neon	250	1/3W	25,000
32G1-2112T	Green	Incandescent	6	.20A	5,000
32G3-2112T	Green	Incandescent	14	.10A	10,000
32G18-2112T	Green	Incandescent	28	.04A	7,000
32-2113T	Amber	Neon	125	1/3W	25,000
35-2113T	Amber	Neon	250	1/3W	25,000
32G1-2113T	Amber	Incandescent	6	.20A	5,000
32G3-2113T	Amber	Incandescent	14	.10A	10,000
32G18-2113T	Amber	Incandescent	28	.04A	7,000
32-2114T	Blue	Neon	125	1/3W	25,000
35-2114T	Blue	Neon	250	1/3W	25,000
32G1-2114T	Blue	Incandescent	6	.20A	5,000
32G3-2114T	Blue	Incandescent	14	.10A	10,000
32G18-2114T	Blue	Incandescent	28	.04A	7,000
32-2115T	White	Neon	125	1/3W	25,000
35-2115T	White	Neon	250	1/3W	25,000
32G1-2115T	White	Incandescent	6	.20A	5,000
32G3-2115T	White	Incandescent	14	.10A	10,000
32G18-2115T	White	Incandescent	28	.04A	7,000
32-2117T	Clear	Neon	125	1/3W	25,000
35-2117T	Clear	Neon	250	1/3W	25,000
32G1-2117T	Clear	Incandescent	6	.20A	5,000
32G3-2117T	Clear	Incandescent	14	.10A	10,000
32G18-2117T	Clear	Incandescent	28	.04A	7,000

Pressfit Indicator Lights for 1/2 Dia. Mounting Hole

32/35 SERIES
Flat Cylindrical Lens
Nickel Plated Bezel
Neon or
Incandescent

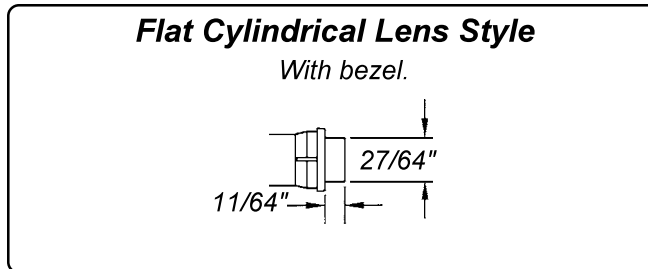

3/16" Tab Terminals
White Housing
6 to 250 Design Volts
PressFit Mounting

Part Number 3/16" Tab Terminals	Lens Color	Lamp Type	Design Volts	Design Watts or Amps	Life (hrs)
32R-2111T	Red	Neon	125	1/3W	25,000
35R-2111T	Red	Neon	250	1/3W	25,000
32RG1-2111T	Red	Incandescent	6	.20A	5,000
32RG3-2111T	Red	Incandescent	14	.10A	10,000
32RG18-2111T	Red	Incandescent	28	.04A	7,000
32R-2112T	Green	Neon	125	1/3W	25,000
35R-2112T	Green	Neon	250	1/3W	25,000
32RG1-2112T	Green	Incandescent	6	.20A	5,000
32RG3-2112T	Green	Incandescent	14	.10A	10,000
32RG18-2112T	Green	Incandescent	28	.04A	7,000
32R-2113T	Amber	Neon	125	1/3W	25,000
35R-2113T	Amber	Neon	250	1/3W	25,000
32RG1-2113T	Amber	Incandescent	6	.20A	5,000
32RG3-2113T	Amber	Incandescent	14	.10A	10,000
32RG18-2113T	Amber	Incandescent	28	.04A	7,000
32R-2114T	Blue	Neon	125	1/3W	25,000
35R-2114T	Blue	Neon	250	1/3W	25,000
32RG1-2114T	Blue	Incandescent	6	.20A	5,000
32RG3-2114T	Blue	Incandescent	14	.10A	10,000
32RG18-2114T	Blue	Incandescent	28	.04A	7,000
32R-2115T	White	Neon	125	1/3W	25,000
35R-2115T	White	Neon	250	1/3W	25,000
32RG1-2115T	White	Incandescent	6	.20A	5,000
32RG3-2115T	White	Incandescent	14	.10A	10,000
32RG18-2115T	White	Incandescent	28	.04A	7,000
32R-2117T	Clear	Neon	125	1/3W	25,000
35R-2117T	Clear	Neon	250	1/3W	25,000
32RG1-2117T	Clear	Incandescent	6	.20A	5,000
32RG3-2117T	Clear	Incandescent	14	.10A	10,000
32RG18-2117T	Clear	Incandescent	28	.04A	7,000

Pressfit Indicator Lights for 1/2 Dia. Mounting Hole

32/35 SERIES

Flush Lens
Without Bezel
Neon or
Incandescent

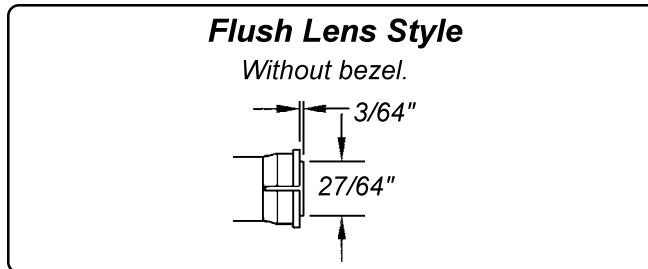

3/16" Tab Terminals
White Housing
6 to 250 Design Volts
PressFit Mounting

Part Number 3/16" Tab Terminals	Lens Color	Lamp Type	Design Volts	Design Watts or Volts	Life (hrs)
32-2311T	Red	Neon	125	1/3W	25,000
35-2311T	Red	Neon	250	1/3W	25,000
32G1-2311T	Red	Incandescent	6	.20A	5,000
32G3-2311T	Red	Incandescent	14	.10A	10,000
32G18-2311T	Red	Incandescent	28	.04A	7,000
32-2312T	Green	Neon	125	1/3W	25,000
35-2312T	Green	Neon	250	1/3W	25,000
32G1-2312T	Green	Incandescent	6	.20A	5,000
32G3-2312T	Green	Incandescent	14	.10A	10,000
32G18-2312T	Green	Incandescent	28	.04A	7,000
32-2313T	Amber	Neon	125	1/3W	25,000
35-2313T	Amber	Neon	250	1/3W	25,000
32G1-2313T	Amber	Incandescent	6	.20A	5,000
32G3-2313T	Amber	Incandescent	14	.10A	10,000
32G18-2313T	Amber	Incandescent	28	.04A	7,000
32-2314T	Blue	Neon	125	1/3W	25,000
35-2314T	Blue	Neon	250	1/3W	25,000
32G1-2314T	Blue	Incandescent	6	.20A	5,000
32G3-2314T	Blue	Incandescent	14	.10A	10,000
32G18-2314T	Blue	Incandescent	28	.04A	7,000
32-2315T	White	Neon	125	1/3W	25,000
35-2315T	White	Neon	250	1/3W	25,000
32G1-2315T	White	Incandescent	6	.20A	5,000
32G3-2315T	White	Incandescent	14	.10A	10,000
32G18-2315T	White	Incandescent	28	.04A	7,000
32-2317T	Clear	Neon	125	1/3W	25,000
35-2317T	Clear	Neon	250	1/3W	25,000
32G1-2317T	Clear	Incandescent	6	.20A	5,000
32G3-2317T	Clear	Incandescent	14	.10A	10,000
32G18-2317T	Clear	Incandescent	28	.04A	7,000

Pressfit Indicator Lights for 1/2 Dia. Mounting Hole

32/35 SERIES
Flush Lens
Nickel Plated Bezel
Neon or
Incandescent

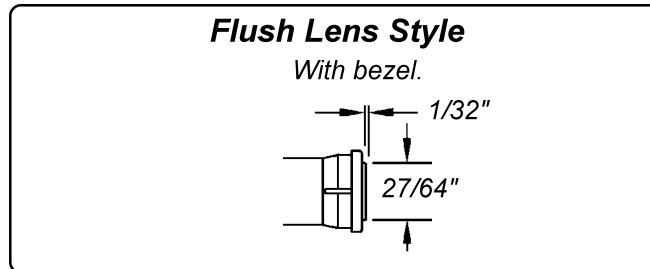

3/16" Tab Terminals
White Housing
6 to 250 Design Volts
PressFit Mounting

Part Number 3/16" Tab Terminals	Lens Color	Lamp Type	Design Volts	Design Watts or Amps	Life (hrs)
32R-2311T	Red	Neon	125	1/3W	25,000
35R-2311T	Red	Neon	250	1/3W	25,000
32RG1-2311T	Red	Incandescent	6	.20A	5,000
32RG3-2311T	Red	Incandescent	14	.10A	10,000
32RG18-2311T	Red	Incandescent	28	.04A	7,000
32R-2312T	Green	Neon	125	1/3W	25,000
35R-2312T	Green	Neon	250	1/3W	25,000
32RG1-2312T	Green	Incandescent	6	.20A	5,000
32RG3-2312T	Green	Incandescent	14	.10A	10,000
32RG18-2312T	Green	Incandescent	28	.04A	7,000
32R-2313T	Amber	Neon	125	1/3W	25,000
35R-2313T	Amber	Neon	250	1/3W	25,000
32RG1-2313T	Amber	Incandescent	6	.20A	5,000
32RG3-2313T	Amber	Incandescent	14	.10A	10,000
32RG18-2313T	Amber	Incandescent	28	.04A	7,000
32R-2314T	Blue	Neon	125	1/3W	25,000
35R-2314T	Blue	Neon	250	1/3W	25,000
32RG1-2314T	Blue	Incandescent	6	.20A	5,000
32RG3-2314T	Blue	Incandescent	14	.10A	10,000
32RG18-2314T	Blue	Incandescent	28	.04A	7,000
32R-2315T	White	Neon	125	1/3W	25,000
35R-2315T	White	Neon	250	1/3W	25,000
32RG1-2315T	White	Incandescent	6	.20A	5,000
32RG3-2315T	White	Incandescent	14	.10A	10,000
32RG18-2315T	White	Incandescent	28	.04A	7,000
32R-2317T	Clear	Neon	125	1/3W	25,000
35R-2317T	Clear	Neon	250	1/3W	25,000
32RG1-2317T	Clear	Incandescent	6	.20A	5,000
32RG3-2317T	Clear	Incandescent	14	.10A	10,000
32RG18-2317T	Clear	Incandescent	28	.04A	7,000

Pressfit Indicator Lights for 1/2 Dia. Mounting Hole

32/35 SERIES

Hi-Hat Lens
Without Bezel
Neon or
Incandescent

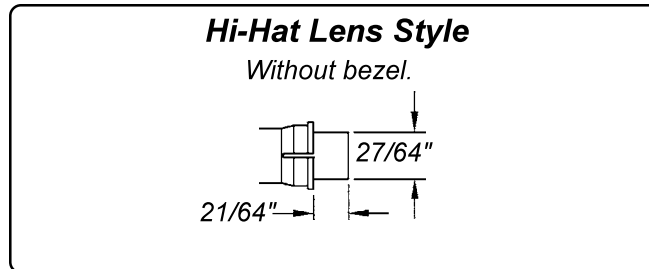

3/16" Tab Terminals
White Housing
6 to 250 Design Volts
PressFit Mounting

Part Number 3/16" Tab Terminals	Lens Color	Lamp Type	Design Volts	Design Watts or Amps	Life (hrs)
32-2511T	Red	Neon	125	1/3W	25,000
35-2511T	Red	Neon	250	1/3W	25,000
32G1-2511T	Red	Incandescent	6	.20A	5,000
32G3-2511T	Red	Incandescent	14	.10A	10,000
32G18-2511T	Red	Incandescent	28	.04A	7,000
32-2512T	Green	Neon	125	1/3W	25,000
35-2512T	Green	Neon	250	1/3W	25,000
32G1-2512T	Green	Incandescent	6	.20A	5,000
32G3-2512T	Green	Incandescent	14	.10A	10,000
32G18-2512T	Green	Incandescent	28	.04A	7,000
32-2513T	Amber	Neon	125	1/3W	25,000
35-2513T	Amber	Neon	250	1/3W	25,000
32G1-2513T	Amber	Incandescent	6	.20A	5,000
32G3-2513T	Amber	Incandescent	14	.10A	10,000
32G18-2513T	Amber	Incandescent	28	.04A	7,000
32-2514T	Blue	Neon	125	1/3W	25,000
35-2514T	Blue	Neon	250	1/3W	25,000
32G1-2514T	Blue	Incandescent	6	.20A	5,000
32G3-2514T	Blue	Incandescent	14	.10A	10,000
32G18-2514T	Blue	Incandescent	28	.04A	7,000
32-2515T	White	Neon	125	1/3W	25,000
35-2515T	White	Neon	250	1/3W	25,000
32G1-2515T	White	Incandescent	6	.20A	5,000
32G3-2515T	White	Incandescent	14	.10A	10,000
32G18-2515T	White	Incandescent	28	.04A	7,000
32-2517T	Clear	Neon	125	1/3W	25,000
35-2517T	Clear	Neon	250	1/3W	25,000
32G1-2517T	Clear	Incandescent	6	.20A	5,000
32G3-2517T	Clear	Incandescent	14	.10A	10,000
32G18-2517T	Clear	Incandescent	28	.04A	7,000

Pressfit Indicator Lights for 1/2 Dia. Mounting Hole

32/35 SERIES

Hi-Hat Lens
Nickel Plated Bezel
Neon or
Incandescent

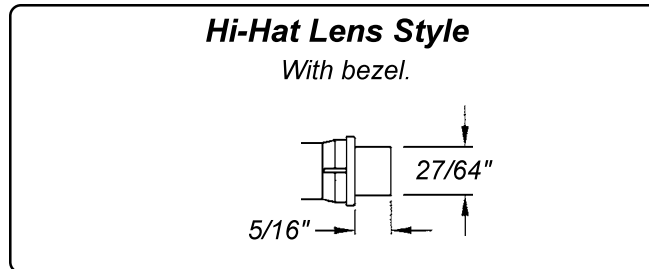

3/16" Tab Terminals
White Housing
6 to 250 Design Volts
PressFit Mounting

Part Number 3/16" Tab Terminals	Lens Color	Lamp Type	Design Volts	Design Watts or Amps	Life (hrs)
32R-2511T	Red	Neon	125	1/3W	25,000
35R-2511T	Red	Neon	250	1/3W	25,000
32RG1-2511T	Red	Incandescent	6	.20A	5,000
32RG3-2511T	Red	Incandescent	14	.10A	10,000
32RG18-2511T	Red	Incandescent	28	.04A	7,000
32R-2512T	Green	Neon	125	1/3W	25,000
35R-2512T	Green	Neon	250	1/3W	25,000
32RG1-2512T	Green	Incandescent	6	.20A	5,000
32RG3-2512T	Green	Incandescent	14	.10A	10,000
32RG18-2512T	Green	Incandescent	28	.04A	7,000
32R-2513T	Amber	Neon	125	1/3W	25,000
35R-2513T	Amber	Neon	250	1/3W	25,000
32RG1-2513T	Amber	Incandescent	6	.20A	5,000
32RG3-2513T	Amber	Incandescent	14	.10A	10,000
32RG18-2513T	Amber	Incandescent	28	.04A	7,000
32R-2514T	Blue	Neon	125	1/3W	25,000
35R-2514T	Blue	Neon	250	1/3W	25,000
32RG1-2514T	Blue	Incandescent	6	.20A	5,000
32RG3-2514T	Blue	Incandescent	14	.10A	10,000
32RG18-2514T	Blue	Incandescent	28	.04A	7,000
32R-2515T	White	Neon	125	1/3W	25,000
35R-2515T	White	Neon	250	1/3W	25,000
32RG1-2515T	White	Incandescent	6	.20A	5,000
32RG3-2515T	White	Incandescent	14	.10A	10,000
32RG18-2515T	White	Incandescent	28	.04A	7,000
32R-2517T	Clear	Neon	125	1/3W	25,000
35R-2517T	Clear	Neon	250	1/3W	25,000
32RG1-2517T	Clear	Incandescent	6	.20A	5,000
32RG3-2517T	Clear	Incandescent	14	.10A	10,000
32RG18-2517T	Clear	Incandescent	28	.04A	7,000

Pressfit Indicator Lights for 1/2 Dia. Mounting Hole

L32/35 SERIES
LED Indicator Lights
White Housing
2 to 24 Design Volts

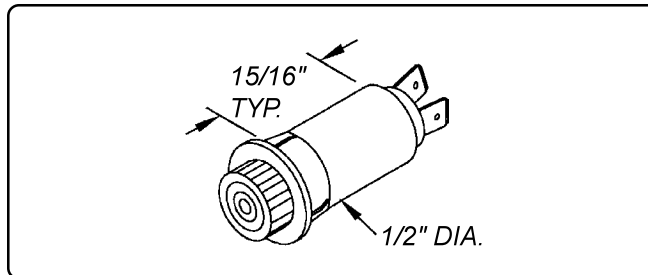

3/16" Tab Terminals
Nickel Plated Bezel
Variety of Lenses
and Colors

Part Number With Flat Cylindrical Lens	Part Number with Flush Lens	Part Number With Hi-Hat Lens	Lens Color	DC Design Volts
L32R-A2-2113T	L32R-A2-2313T	L32R-A2-2513T	Amber	2
L32R-A6-2113T	L32R-A6-2313T	L32R-A6-2513T	Amber	6
L32R-A12-2113T	L32R-A12-2313T	L32R-A12-2513T	Amber	12
L32R-A24-2113T	L32R-A24-2313T	L32R-A24-2513T	Amber	24
L32R-G2-2112T	L32R-G2-2312T	L32R-G2-2512T	Green	2
L32R-G6-2112T	L32R-G6-2312T	L32R-G6-2512T	Green	6
L32R-G12-2112T	L32R-G12-2312T	L32R-G12-2512T	Green	12
L32R-G24-2112T	L32R-G24-2312T	L32R-G24-2512T	Green	24
L32R-R2-2111T	L32R-R2-2311T	L32R-R2-2511T	Red	2
L32R-R6-2111T	L32R-R6-2311T	L32R-R6-2511T	Red	6
L32R-R12-2111T	L32R-R12-2311T	L32R-R12-2511T	Red	12
L32R-R24-2111T	L32R-R24-2311T	L32R-R24-2511T	Red	24
L32R-Y2-2116T	L32R-Y2-2316T	L32R-Y2-2516T	Yellow	2
L32R-Y6-2116T	L32R-Y6-2316T	L32R-Y6-2516T	Yellow	6
L32R-Y12-2116T	L32R-Y12-2316T	L32R-Y12-2516T	Yellow	12
L32R-Y24-2116T	L32R-Y24-2316T	L32R-Y24-2516T	Yellow	24

Polarity Determination - Wire Leads: Red wire lead denotes anode (+); black wire lead denotes cathode (-).
Terminals: One terminal is tin-plated to denote anode (+); unplated terminal refers to cathode (-).

