

ORDER NO.	WOODHEAD NO.	COLOR
130147-0299	29W49-P	YELLOW

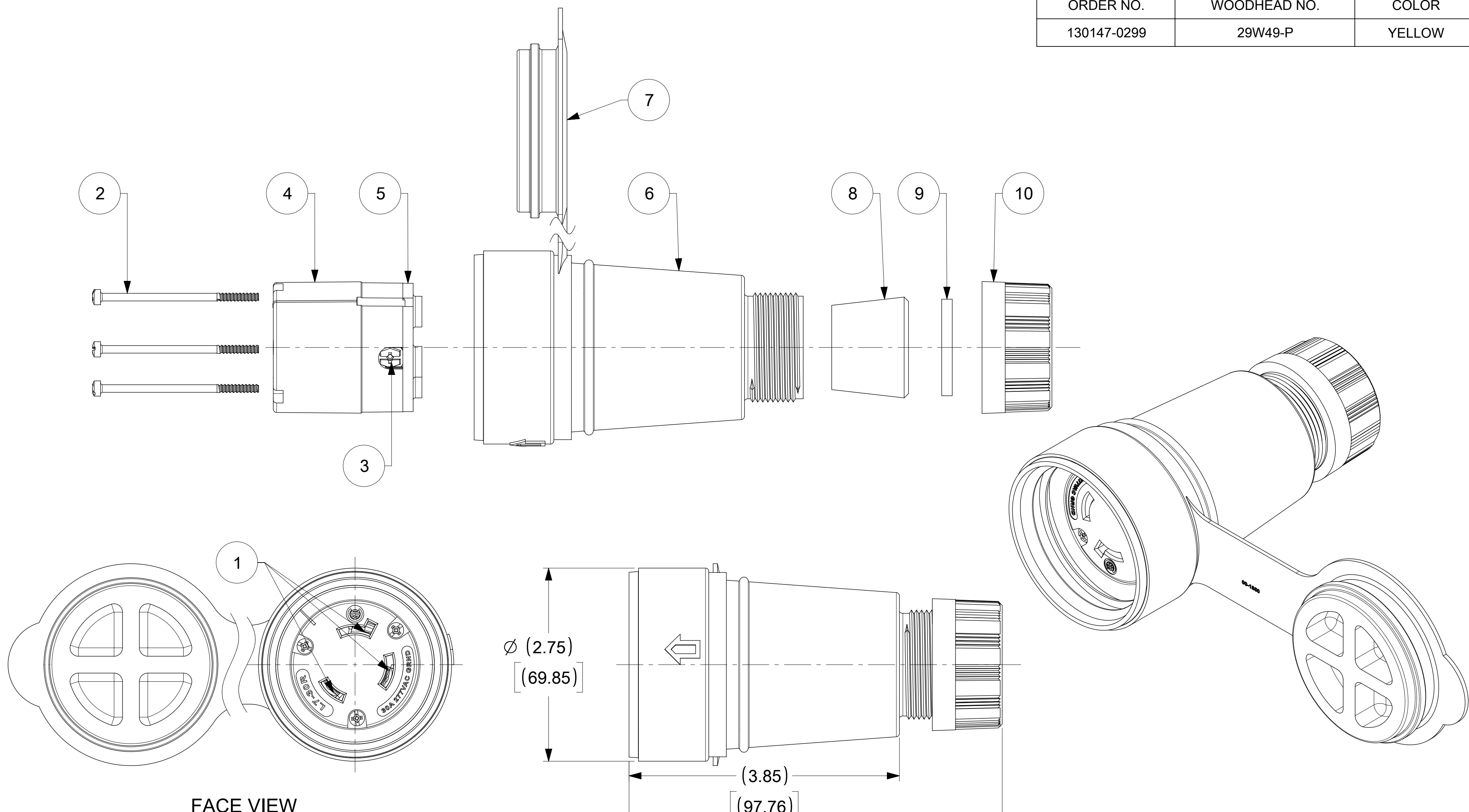

FACE VIEW

ITEM NO.	DESCRIPTIONS	MATERIAL	QTY.
1	BLADE	BRASS, NICKEL PLATED	3
2	RETAINING SCREWS	STAINLESS STEEL	3
3	CLAMP AND TERMINAL SCREW ASSY	BRASS, ZINC PLATED	3
4	INSERT	NYLON	1
5	TERMINAL COVER	POLYCARBONATE	1
6	HOUSING	SILICON WITH NYLON THREAD	1
7	COVER CLOSURE	SILICON WITH NYLON THREAD	1
8	GROMMET	RUBBER	4
9	FRICTION RING	NYLON	1
10	COMPRESSION NUT	NYLON	1

SYMBOLS DIMENSION UNITS: INCH[MM] SCALE: NTS CURRENT REV DESC: RELEASED		molex WATERTITE CONNECTOR 2P3W L7-30	
GENERAL TOLERANCES (UNLESS SPECIFIED) 4 PLACES ± 3 PLACES ± 2 PLACES ± 1 PLACE ± 0 PLACES ±		EC NO: 614386 DRWN: DSOPPIN 2018/12/28 CHK'D: DNGUYEN62 2019/04/17 APPR: HKNEELAND 2019/04/25	
ANGULAR TOL ± ° DRAFT WHERE APPLICABLE MUST REMAIN WITHIN DIMENSIONS		INITIAL REVISION: DRWN: DSOPPIN 2018/12/28 APPR: HKNEELAND 2019/04/25	
THIRD ANGLE PROJECTION		DRAWING SERIES: C-SIZE 130147	
DOCUMENT STATUS: P1 RELEASE DATE: 2019/04/25 22:02:44		PRODUCT CUSTOMER DRAWING DOCUMENT NUMBER: 1301470299 DOC TYPE: PSD DOC PART: 000 REVISION: A MATERIAL NUMBER: SEE TABLE CUSTOMER: GENERAL MARKET SHEET NUMBER: 1 OF 1	