

N-Channel Enhancement Mode Power MOSFET

Description

The RMD1N25ES9 uses advanced trench technology to provide excellent $R_{DS(ON)}$ and low gate charge. The complementary MOSFETs may be used to form a level shifted high side switch, and for a host of other applications.

General Features

- $V_{DS} = 25V, I_D = 1.1A$
 $R_{DS(ON)} < 550 m\Omega @ V_{GS}=4.5V$
 $R_{DS(ON)} < 650 m\Omega @ V_{GS}=2.5V$
- High power and current handling capability
- Lead free product is acquired
- Surface mount package
- Halogen-free
- P/N suffix V means AEC-Q101 qualified, e.g:RMD1N25ES9V

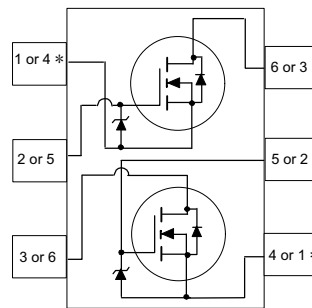

Top View

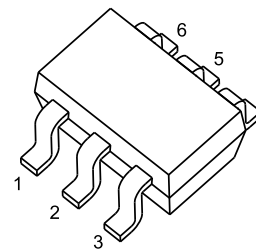

SOT-363

Package Marking and Ordering Information

Device Marking	Device	Device Package	Reel Size	Tape width	Quantity
1N25	RMD1N25ES9	SOT-363	Ø180mm	8mm	3000units

Absolute Maximum Ratings ($T_A=25^\circ C$ unless otherwise noted)

Parameter	Symbol	Value	Unit
Drain-Source Voltage	V_{DS}	25	V
Gate-Source Voltage	V_{GS}	± 12	V
Continuous Drain Current	I_D	1.1	A
Pulsed Drain Current ^(Note 1)	I_{DM}	5	A
Maximum Power Dissipation	P_D	0.8	W
Operating Junction and Storage Temperature Range	T_J, T_{STG}	-55 To 150	$^\circ C$

Thermal Characteristic

Thermal Resistance, Junction-to-Ambient	$R_{\theta JA}$	156	$^\circ C/W$
---	-----------------	-----	--------------

Electrical Characteristics ($T_A = 25\text{ }^\circ\text{C}$ Unless Otherwise Noted)

Symbol	Parameter	Conditions	Min	Typ	Max	Unit
Static Characteristics						
BV_{DSS}	Drain-Source Breakdown Voltage	$V_{GS} = 0\text{ V}, I_{DS} = 250\text{ }\mu\text{A}$	25	-	-	V
$V_{GS(th)}$	Gate Threshold Voltage	$V_{DS} = V_{GS}, I_{DS} = 250\text{ }\mu\text{A}$	0.4	0.7	1.1	V
I_{DSS}	Drain Leakage Current	$V_{DS} = 25\text{ V}, V_{GS} = 0\text{ V}$	-	-	1	μA
		$T_J = 85\text{ }^\circ\text{C}$	-	-	30	μA
I_{GSS}	Gate Leakage Current	$V_{GS} = \pm 10\text{ V}, V_{DS} = 0\text{ V}$	-	-	± 10	μA
$R_{DS(on)}^a$	On-State Resistance	$V_{GS} = 4.5\text{ V}, I_{DS} = 0.5\text{ A}$	-	0.5	0.6	Ω
		$V_{GS} = 2.5\text{ V}, I_{DS} = 0.2\text{ A}$	-	0.55	0.7	
Diode Characteristics						
V_{SD}^a	Diode Forward Voltage	$I_{SD} = 0.5\text{ A}, V_{GS} = 0\text{ V}$	-	-	1.3	V
t_{rr}	Reverse Recovery Time	$I_{SD} = 0.5\text{ A}, dI_{SD}/dt = 100\text{ A}/\mu\text{s}$	-	40	-	ns
Q_{rr}	Reverse Recovery Charge		-	39	-	nC
Dynamic Characteristics^b						
C_{iss}	Input Capacitance	$V_{GS} = 0\text{ V}, V_{DS} = 10\text{ V}$ Frequency = 1 MHz	-	30	-	pF
C_{oss}	Output Capacitance		-	3	-	
C_{rss}	Reverse Transfer Capacitance		-	1	-	
$t_d(on)$	Turn-on Delay Time	$V_{DS} = 30\text{ V}, V_{GEN} = 10\text{ V},$ $R_G = 25\text{ }\Omega, R_L = 60\text{ }\Omega,$ $I_{DS} = 0.95\text{ A}$	-	3.6	-	ns
t_r	Turn-on Rise Time		-	3.3	-	
$t_d(off)$	Turn-off Delay Time		-	20	-	
t_f	Turn-off Fall Time		-	11	-	
Q_g	Total Gate Charge	$V_{GS} = 4.5\text{ V}, V_{DS} = 10\text{ V},$ $I_{DS} = 0.95\text{ A}$	-	0.6	-	pC
Q_{gs}	Gate-Source Charge		-	0.26	-	
Q_{gd}	Gate-Drain Charge		-	0.17	-	

Notes :

a : Pulse test ; pulse width $\leq 300\text{ }\mu\text{s}$, duty cycle $\leq 2\%$

b : Guaranteed by design, not subject to production testing

RATING AND CHARACTERISTICS CURVES (RMD1N25ES9)

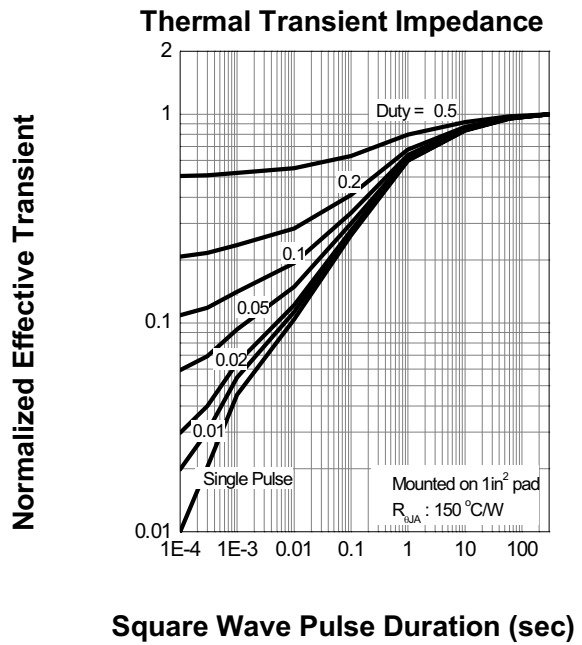
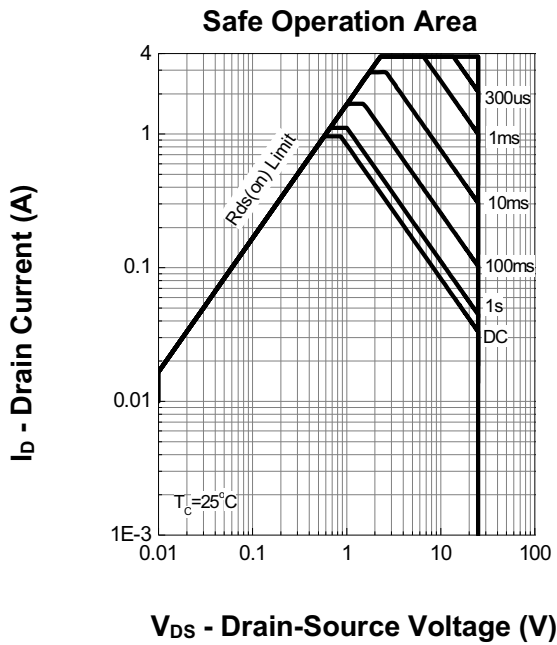
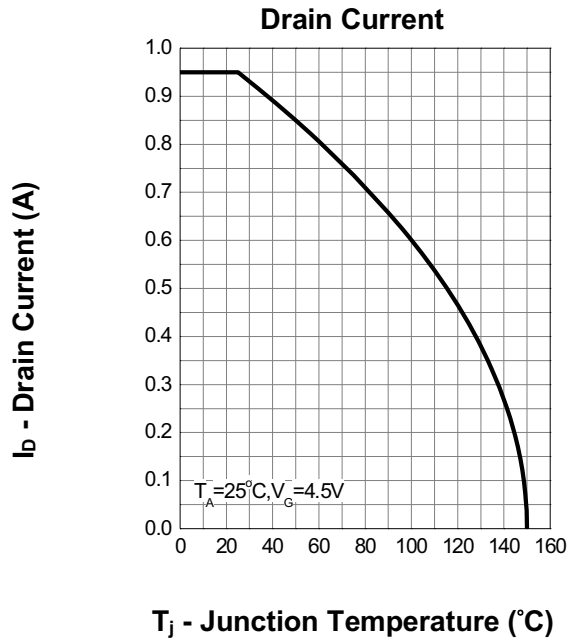
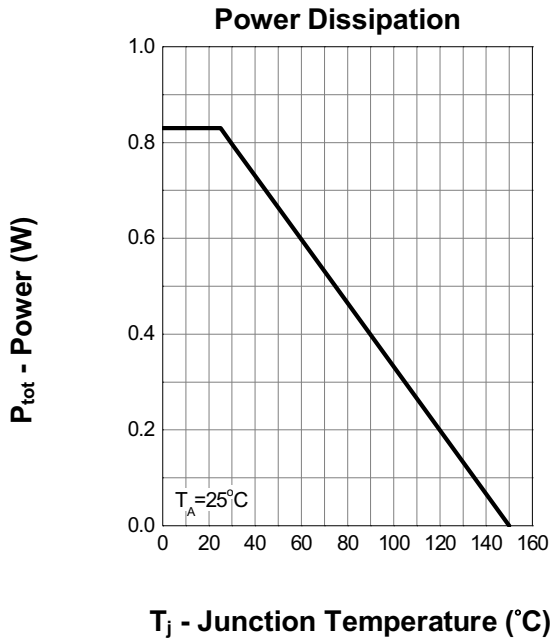

RATING AND CHARACTERISTICS CURVES (RMD1N25ES9)

Output Characteristics

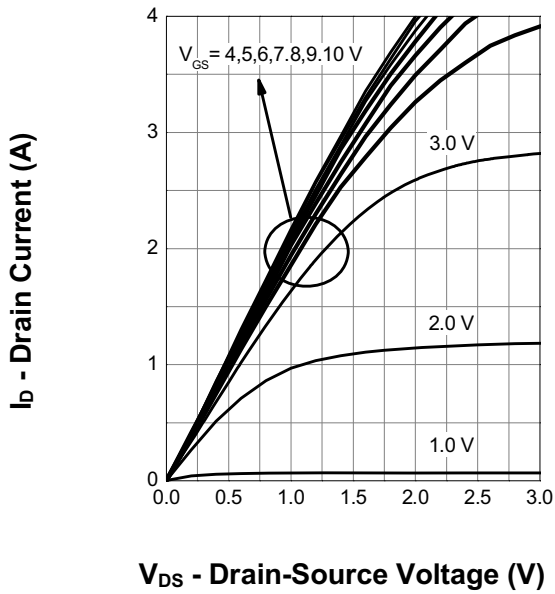

Drain-Source On Resistance

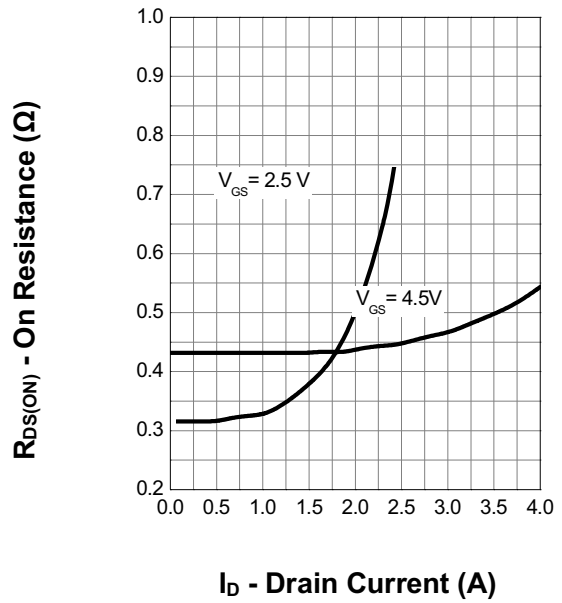

Transfer Characteristics

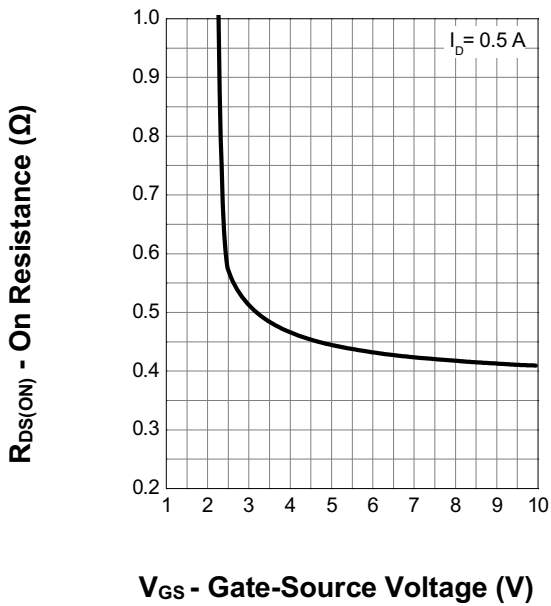

Gate Threshold Voltage

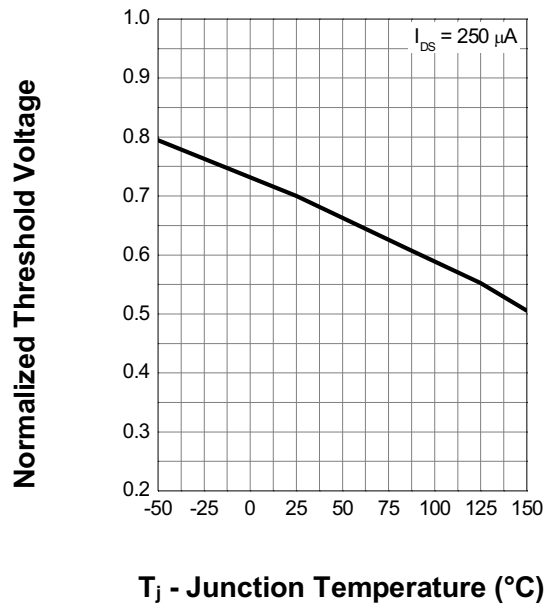

RATING AND CHARACTERISTICS CURVES (RMD1N25ES9)

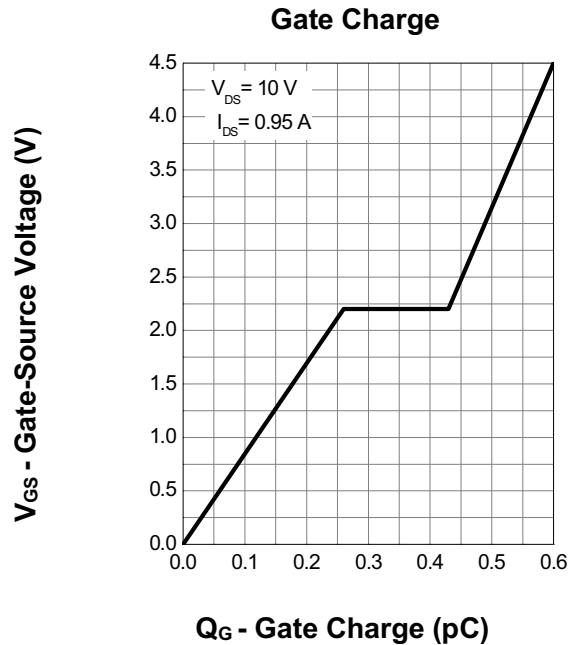
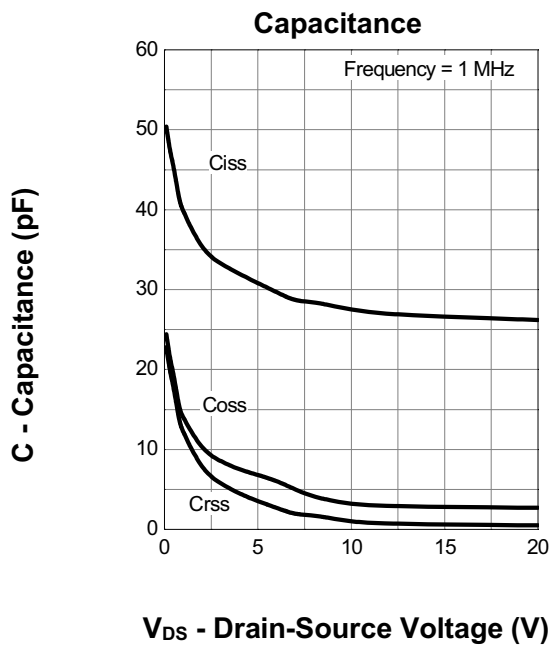
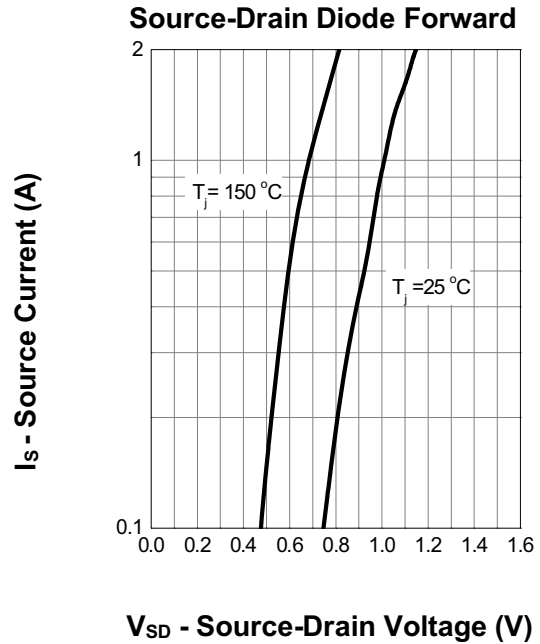
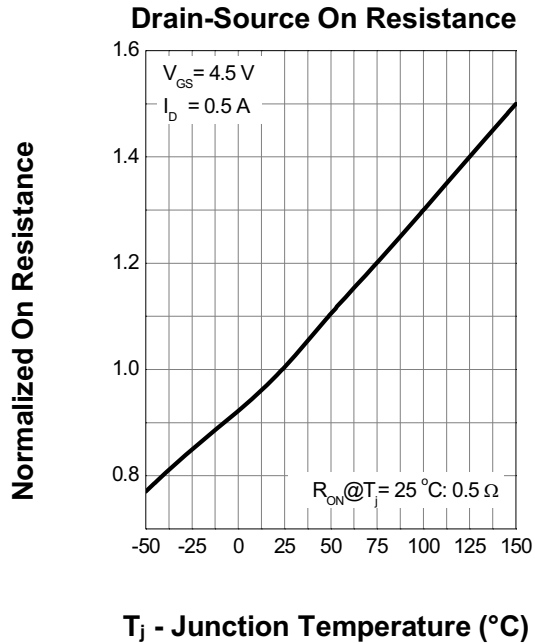

Package Dimensions

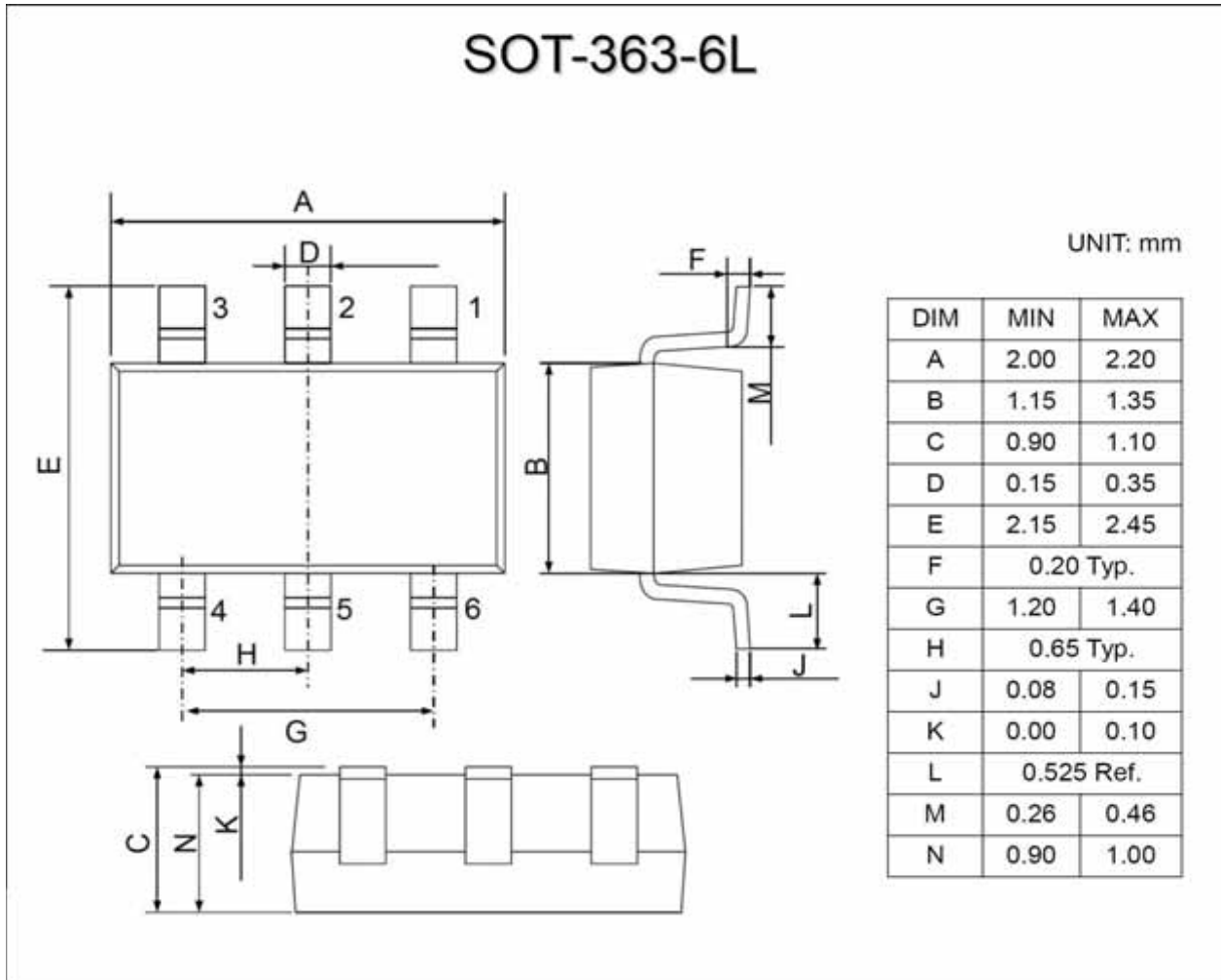

PKG	Reel	Box	pcs/reel	reel/box	pcs/box	box/carton	pcs/carton
SOT363	7"		3000	10	30000	4	120000

DISCLAIMER NOTICE

Rectron Inc reserves the right to make changes without notice to any product specification herein, to make corrections, modifications, enhancements or other changes. Rectron Inc or anyone on its behalf assumes no responsibility or liability for any errors or inaccuracies. Data sheet specifications and its information contained are intended to provide a product description only. "Typical" parameters which may be included on RECTRON data sheets and/ or specifications can and do vary in different applications and actual performance may vary over time. Rectron Inc does not assume any liability arising out of the application or use of any product or circuit.

Rectron products are not designed, intended or authorized for use in medical, life-saving implant or other applications intended for life-sustaining or other related applications where a failure or malfunction of component or circuitry may directly or indirectly cause injury or threaten a life without expressed written approval of Rectron Inc. Customers using or selling Rectron components for use in such applications do so at their own risk and shall agree to fully indemnify Rectron Inc and its subsidiaries harmless against all claims, damages and expenditures.