

Fast Switching SCR T7SH_60

600A Avg.
(950 RMS)
Up to 800 Volts
20-40 μ s

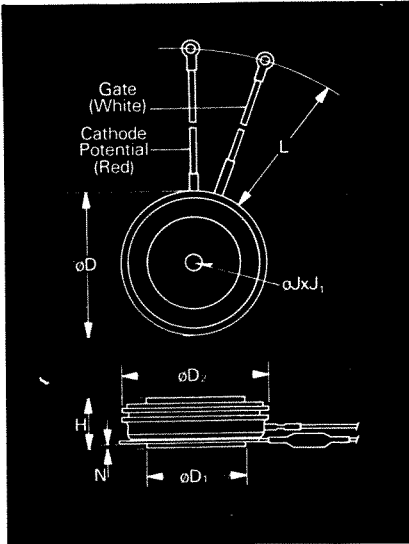

Symbol	Inches		Millimeters	
	Min.	Max.	Min.	Max.
ϕD	1.850	1.900	45.72	48.26
ϕD_1	1.140	1.180	28.96	29.97
ϕD_2	1.760	1.850	44.70	46.99
H	.545	.605	13.84	15.37
ϕJ	.135	.145	3.43	3.68
J ₁	.072	.082	1.83	2.08
L	7.75	8.50	196.85	215.90
N	.025		.64	

Creep Distance—.41 in. min. (10.41 mm).
Strike Distance—.35 in. min. (8.89 mm).
Finish-Nickel Plate.
Approx. Weight—4 oz. (113 g.)
1. Dimension "H" is a clamped dimension.

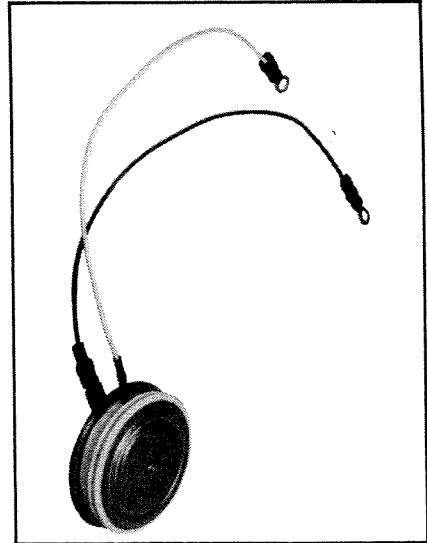

T7S Outline

Features:

- Interdigitated, di/namic Gate structure
- Hard Commutation Turn-Off
- Forward Blocking Voltage Capabilities to 800 Volts
- Low Switching Losses at High Frequency
- Soft Commutation (Feedback Diode) Testing Available
- High di/dt with soft gate control

Applications:

- Induction Heating
- Transportation
- Inverters

Ordering Information

Type	Voltage		Current		Turn-off		Gate current		Leads		
Code	V _{DRM} and V _{RRM} (V)	Code	I _{T(av)} (A)	Code	t _q usec	Code	I _{GT} (ma)	Code	Case	Code	
T7SH	100	01	600	60	20	6	150	4	T7S	DN	
	200	02			25						8
	300	03			30						5
	400	04			40						4
	500	05									
	600	06									
	700	07									
	800	08									

Example

Obtain optimum device performance for your application by selecting proper Order Code.

Type T7SH rated at 600A average with V_{DRM} = 400V
I_{GT} = 150 ma, t_q = 30 μ sec max. and leads—order as:

Type	Voltage	Current	Turn Off	Gate Current	Leads
T 7 S H	0 4	6 0	5	4	D N

**600A Avg.
(950 RMS)
Up to 800 Volts
20-40 μ s**

**Fast Switching
SCR
T7SH_60**

Voltage ①

Blocking State Maximums ($T_J = 125^\circ\text{C}$)

Symbol	100	200	300	400	500	600	700	800
Repetitive peak forward blocking voltage, V	100	200	300	400	500	600	700	800
Repetitive peak reverse voltage, V	100	200	300	400	500	600	700	800
Non-repetitive transient peak reverse voltage, $t \leq 5.0$ msec, V	200	300	400	500	600	700	800	900
Forward leakage current, mA peak					35			
Reverse leakage current, mA peak					35			

Current

Conducting State Maximums
($T_J = 125^\circ\text{C}$)

Symbol	T7SH_60
RMS forward current, A	950
Ave. forward current, A	600
One-half cycle surge current ^② , A	9000
I^2t for fusing (for times ≥ 8.3 ms) $\text{A}^2 \text{sec.}$	338,000
Forward voltage drop at $I_{TM} = 1500\text{A}$ and $T_J = 25^\circ\text{C}$, V	1.55
Min. repetitive di/dt ③④⑤ A/ μ sec	600

Switching

($T_J = 25^\circ\text{C}$)

Symbol	
Max. turn-off time, $I_T = 400\text{A}$, $T_J = 125^\circ\text{C}$ $t_p = 100 \mu\text{sec}$, $di/dt = 25$ A/ μ sec., reapplied $dv/dt = 200\text{V}/\mu\text{sec}$. linear to 0.8 V_{DRM} , μsec . ⑥⑦	t_q 20 to 40
Typ. delay time, $I_{TM} = 1000\text{A}$ $T_D = .8 V_{DRM}$, μsec	t_d .5
Typ turn-on-time $I_{TM} = 1000\text{A}$, μsec	t_{on} 3.0
Min. critical dv/dt exponential to .8 V_{DRM} , $T_J = 125^\circ\text{C}$, V/ μ sec ⑧⑨	dv/dt 300
Min. di/dt , non-repetitive, A/ μ sec ⑩⑪⑫	di/dt 1200

Gate

Maximum Parameters
($T_J = 25^\circ\text{C}$)

Symbol	
Gate current to trigger at $V_D = 12\text{V}$, mA	I_{GT} 150
Gate voltage to trigger at $V_D = 12\text{V}$, V	V_{GT} 3
Non-triggering gate voltage, $T_J = 125^\circ\text{C}$, and rated V_{DRM} , V	V_{GDM} .25
Peak forward gate current, A	I_{GTM} 4
Peak reverse gate voltage, V	V_{GRM} 5
Peak gate power, Watts	P_{GM} 16
Average gate power, Watts	$P_{G(av)}$ 3

Thermal and Mechanical

Symbol	
Min., Max. oper. junction temp., $^\circ\text{C}$	T_J -40 to +125
Min., Max. storage temp., $^\circ\text{C}$	T_{stg} -40 to +150
Max. mounting force, lb. ⑬	2000 to 2400
Thermal resistance ^⑭ , double-side cooling, junction to case, $^\circ\text{C}/\text{Watt}$	$R_{\theta JC}$.045
Case to sink, lubricated, $^\circ\text{C}/\text{Watt}$	$R_{\theta CS}$.02

- ① Consult recommended mounting procedures.
- ② Applies for zero or negative gate bias.
- ③ Per JEDEC RS-397, 5.2.2.1.
- ④ With recommended gate drive.
- ⑤ Higher dv/dt ratings available, consult factory.
- ⑥ Per JEDEC standard RS-397, 5.2.2.6.
- ⑦ For operation with antiparallel diode, consult factory.

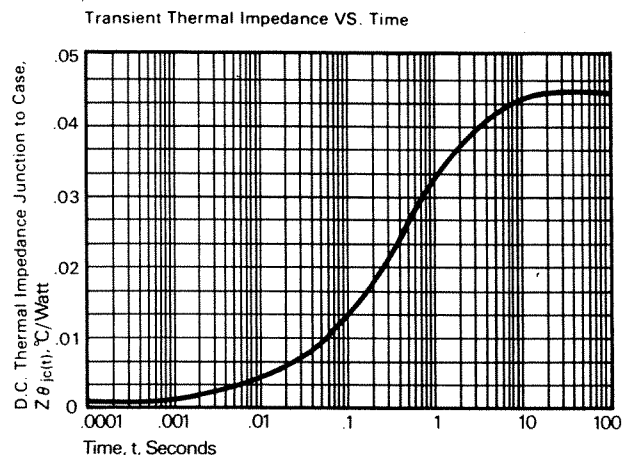
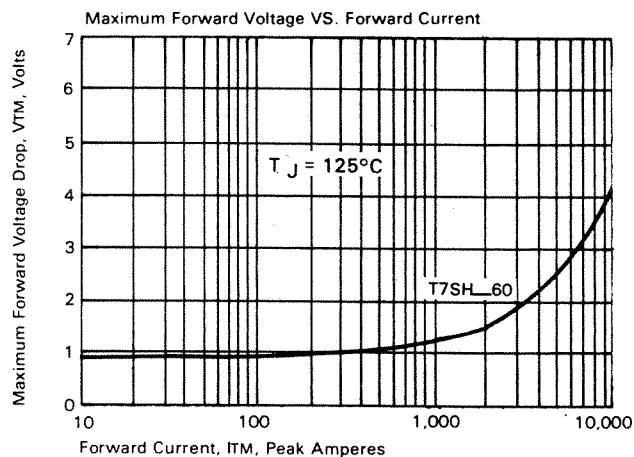

FAST SWITCHING THYRISTORS

Fast Switching SCR T7SH_60

600A Avg.
(950 RMS)
Up to 800 Volts
20-40 μ s

Sinusoidal Current Data

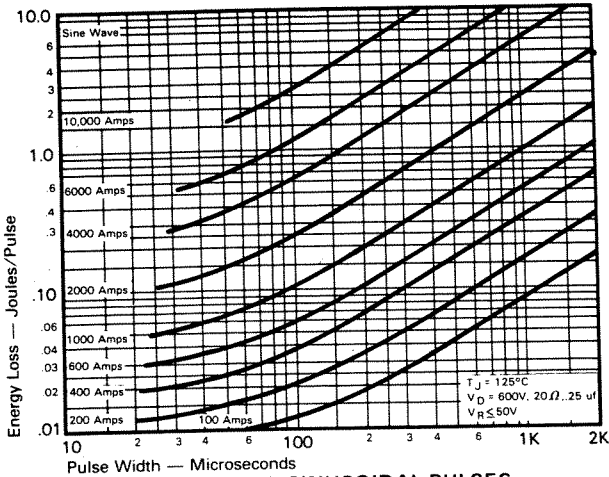

Trapezoidal Wave Current Data

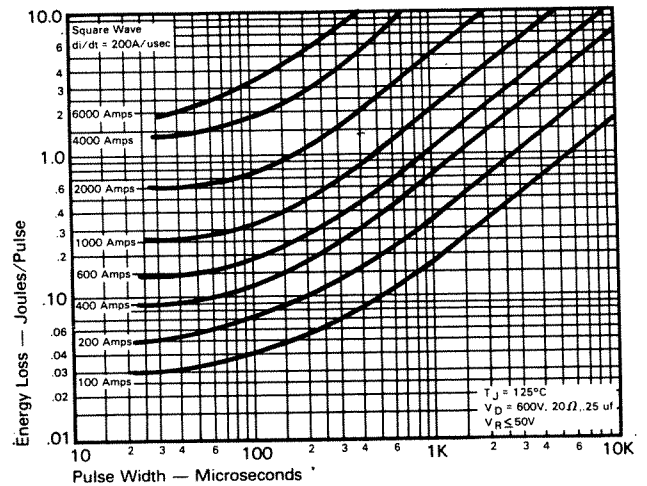
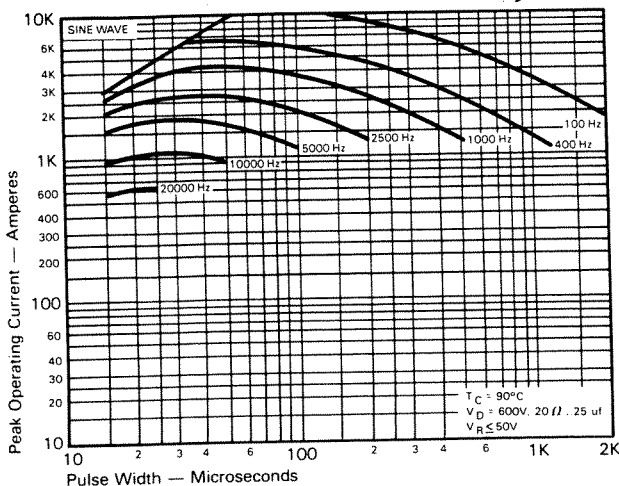
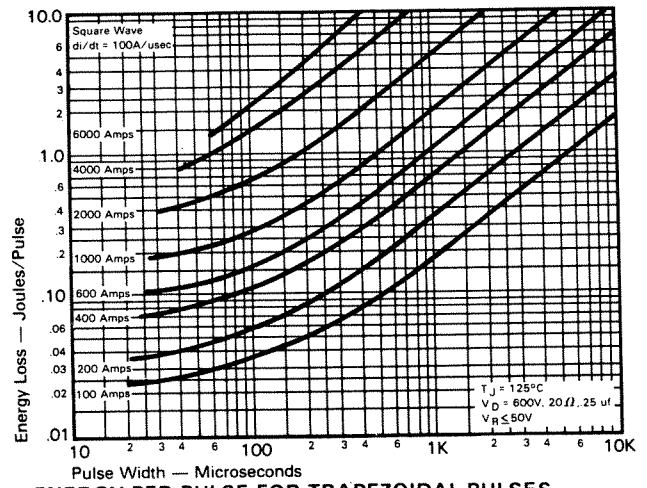
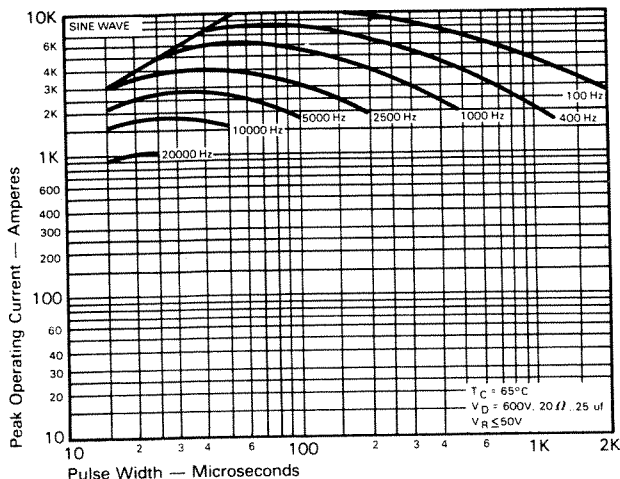
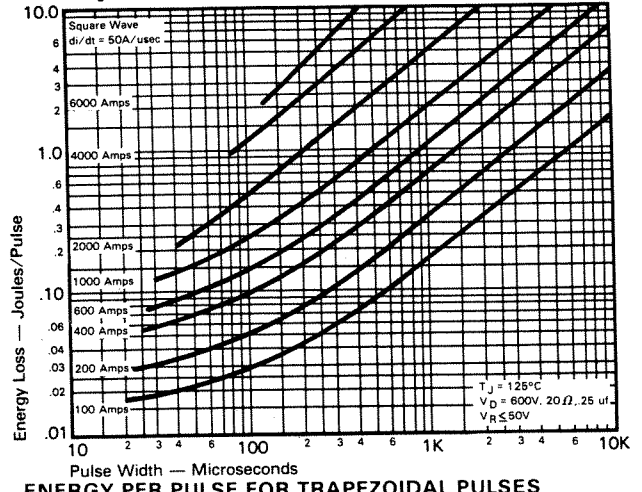

FAST SWITCHING
THYRISTORS

**600A Avg.
(950 RMS)
Up to 800 Volts
20-40 μ s**

**Fast Switching
SCR
T7SH_60**

**Trapezoidal Wave Current Data
($T_C = 65^\circ\text{C}$)**

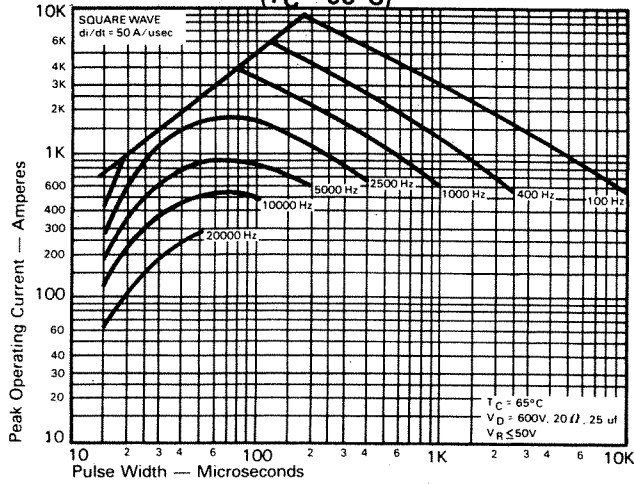

MAXIMUM ALLOWABLE PEAK ON-STATE CURRENT vs. PULSE WIDTH ($di/dt = 50\text{A/usec}$)

**Trapezoidal Wave Current Data
($T_C = 90^\circ\text{C}$)**

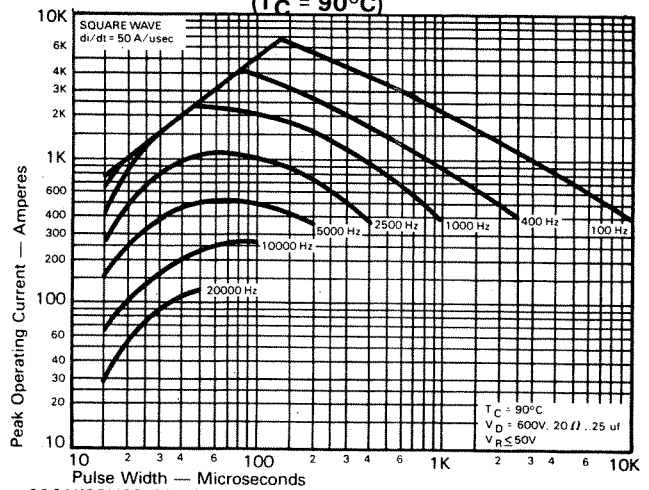

MAXIMUM ALLOWABLE PEAK ON-STATE CURRENT vs. PULSE WIDTH ($di/dt = 50\text{A/usec}$)

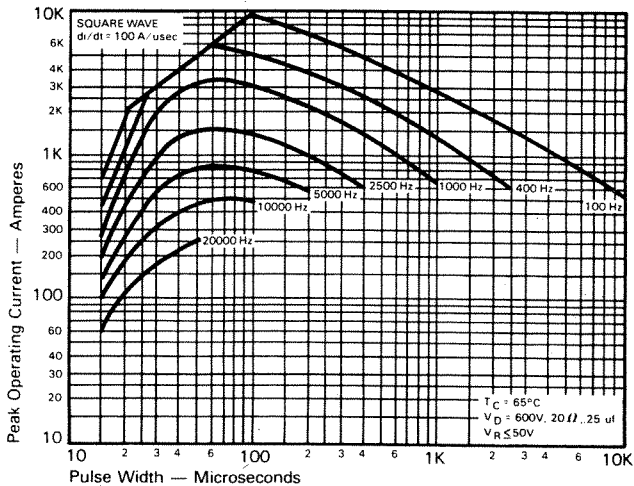

MAXIMUM ALLOWABLE PEAK ON-STATE CURRENT vs. PULSE WIDTH ($di/dt = 100\text{A/usec}$)

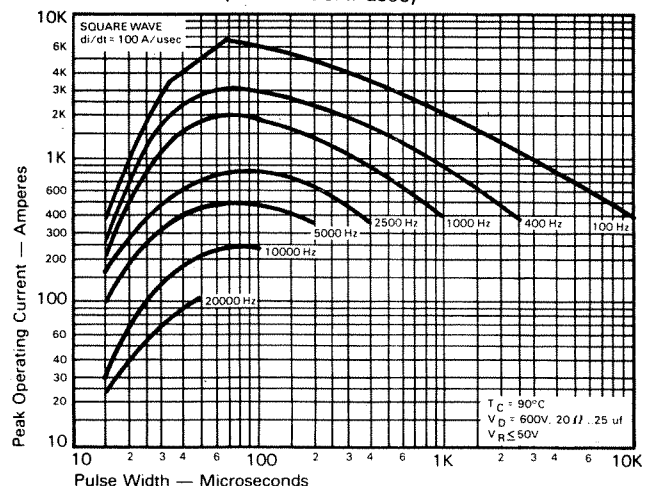

MAXIMUM ALLOWABLE PEAK ON-STATE CURRENT vs. PULSE WIDTH ($di/dt = 100\text{A/usec}$)

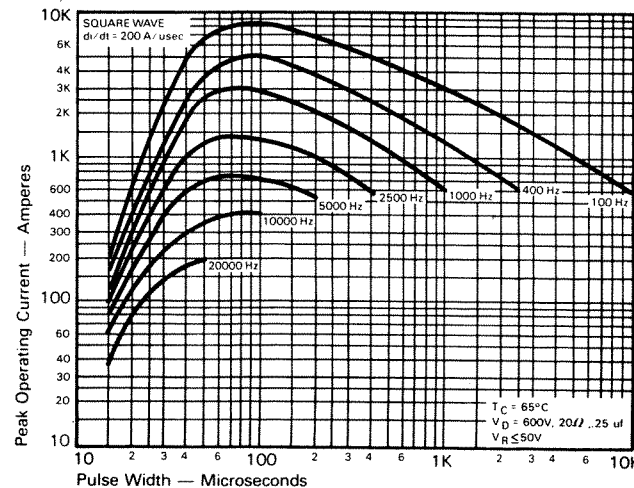

MAXIMUM ALLOWABLE PEAK ON-STATE CURRENT vs. PULSE WIDTH ($di/dt = 200\text{A/usec}$)

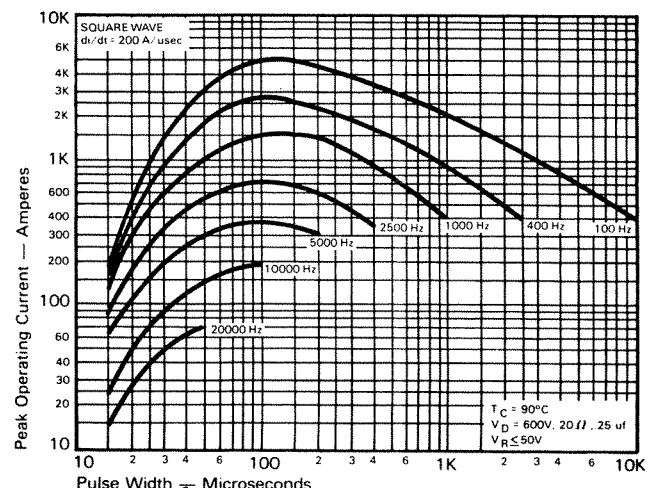

MAXIMUM ALLOWABLE PEAK ON-STATE CURRENT vs. PULSE WIDTH ($di/dt = 200\text{A/usec}$)

FAST SWITCHING THYRISTORS