

4

3

2

1

THIS DRAWING IS UNPUBLISHED.

RELEASED FOR PUBLICATION

20

© COPYRIGHT 20 BY -

ALL RIGHTS RESERVED.

REVISIONS

P	LTR	DESCRIPTION	DATE	DWN	APVD
	A	INITIAL	17APR2015	DW	CW
	B	ECR-15-018270	09DEC2015	DW	CW
	B1	ECR-16-018198	27DEC2016	QY	CW
	C	ECR-21-111798	22SEP2021	WQR	CW

TYPE-1:T2111020101-000 TE LOGO
 类型-1:T2111020101-000 TE LOGO

NOTES:

1. TECHNICAL CHARACTERISTICS:
 INSULATION MATERIAL: PC
 RATED VOLTAGE: 1000V
 RATED CURRENT: 70A
 INSULATION RESISTANCE: $\geq 400M\Omega$
 RATED IMPULSE VOLTAGE: 8KV
 POLLUTION DEGREE: 3
 FLAMMABILITY: UL94V-0
 MATING CYCLES: 500 CYCLES
 WIRE RANGE: 10~25 mm²
 CONTACT TYPE: CRIMP CONTACT

2. CONTACT NEED TO BE ORDERED SEPARATELY.
 (ORDER No. REFER TO DRAWING:T2400001XX0000)

注释:

1. 技术参数:
 绝缘材料: PC
 额定电压: 1000V
 额定电流: 70A
 绝缘电阻: $\geq 400M\Omega$
 额定脉冲电压: 8KV
 污染等级: 3
 阻燃等级: UL94V-0
 插拔次数: 500次
 接线范围: 10~25 mm²
 接线类型: 冷压接

2. 端子需要单独订购.
 (订货号参考图面: T2400001XX0000)

THIS DRAWING IS A CONTROLLED DOCUMENT.

DWN 17APR2015

David Wang

CHK 17APR2015

Chris Wang

APVD 17APR2015

Xiang Xu

PRODUCT SPEC

108-137059

APPLICATION SPEC

114-137059

WEIGHT

-

Customer Drawing

TE Connectivity

NAME

HMN-002-MC

SIZE

A3

CAGE CODE

-

DRAWING NO

T2111020101000

RESTRICTED TO

-

SCALE

3:2

SHEET

1 OF 2

REV

C

DIMENSIONS:

mm

TOLERANCES UNLESS OTHERWISE SPECIFIED:

0 PLC	±-
1 PLC	±-
2 PLC	±-
3 PLC	±-
4 PLC	±-
ANGLES	±-

MATERIAL

-

FINISH

-

1470-19 (3/13)

THIS DRAWING IS UNPUBLISHED.

RELEASED FOR PUBLICATION

20

© COPYRIGHT 20 BY -

ALL RIGHTS RESERVED.

REVISIONS

P	LTR	DESCRIPTION	DATE	DWN	APVD
	-	SEE SHEET 1	-	-	-

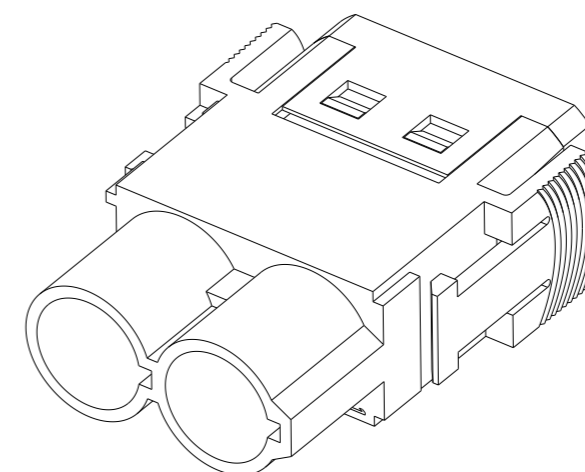
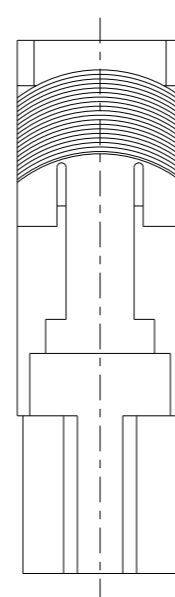
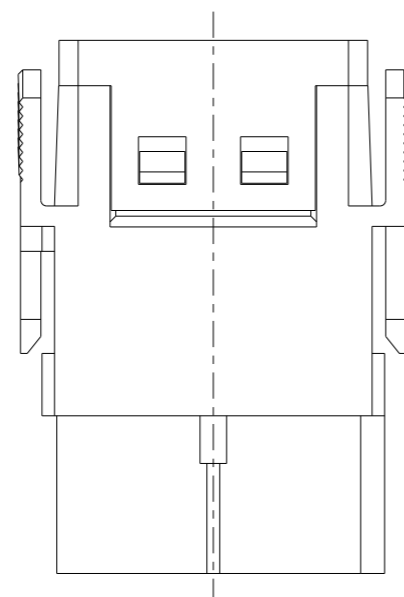
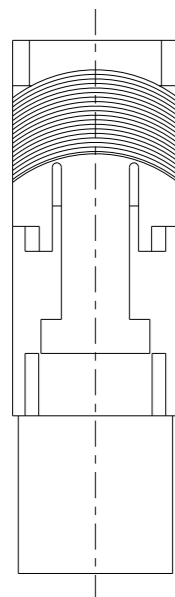
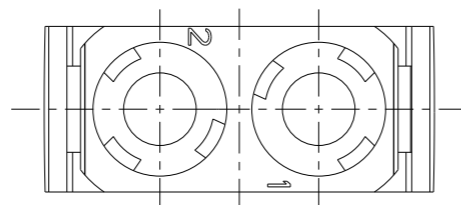

NOTES:
SEE SHEET 1
注释:
见页 1

TYPE-2:T2111020101-001 NO LOGO
类型-2:T2111020101-001 无LOGO

ALL DIMENSIONS ARE SAME AS TYPE 1,
EXCEPT THOSE DEFINED IN THIS TYPE.
除了在本类型中定义的尺寸外,其它尺寸同类型 1

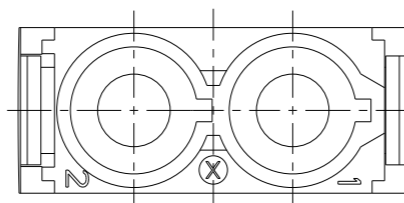

T2111020101-001	HMN-002-MC	HMN-002 MALE MODULE INSERT, CRIMPING, NO LOGO HMN-002冷压型模块公插, 无LOGO	TYPE-2 类型-2
T2111020101-000	HMN-002-MC	HMN-002 MALE MODULE INSERT, CRIMPING HMN-002冷压型模块公插	TYPE-1 类型-1
PART NUMBER 料号	PART DESCRIPTION 描述		TYPE 类型

THIS DRAWING IS A CONTROLLED DOCUMENT.

DWN 17APR2015
David Wang
CHK 17APR2015
Chris Wang
APVD 17APR2015
Xiang Xu



DIMENSIONS:
mm

TOLERANCES UNLESS OTHERWISE SPECIFIED:

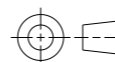

0 PLC ±-
1 PLC ±-
2 PLC ±-
3 PLC ±-
4 PLC ±-
ANGLES ±-
FINISH

MATERIAL
-

PRODUCT SPEC 108-137059
APPLICATION SPEC 114-137059
WEIGHT -

NAME			RESTRICTED TO
HMN-002-MC			-
SIZE	CAGE CODE	DRAWING NO	
A3	00779	©-T2111020101000	

Customer Drawing SCALE 3:2 SHEET 2 OF 2 REV C