

PROPRIETARY INFORMATION:		REVISION			
PROPRIETARY OF GLOBTEK, INC. ANY REPRODUCTION, DISCLOSURE OR USE OF THIS DRAWING, IN WHOLE OR IN PART, IS HEREBY PROHIBITED EXCEPT AS SPECIFIED IN WRITING BY GLOBTEK, INC.		REV	DESCRIPTION	DATE	APPROVED
		A	INITIAL RELEASE, RFS.3470, DMR	04/08/04	DMR
		B	REVISE LABEL, RFS.3490, SO	04/13/04	DMR
		C	UPDATE O/P CONNECTOR, RFS.3614, SO	05/05/04	DMR
		D	UPDATE LABEL, ADD CCC = C-TICK, RFS.5774, DMR	03/21/05	DMR
		E	ADD WEEE TO LABEL, PACKING, RFS.7404, DMR	11/07/05	DMR
		F	CORRECT LABEL, RFS.7583, SO	12/07/05	DMR
		G	ADD ROHS, VCCI, UL1310 CL.2. 10060, SO	01/08/07	HM
		H	ADD CH. ROHS, 10755, SO	04/25/07	HM
		I	UPDATE PACKING, 17476, SO	11/13/09	HM
		J	ADD FERRITE TO O/P CORD, REVISE LABEL, 19272, SO	08/16/10	HM
		K	REMOVE CENTER POSITIVE DIAGRAM FROM LABEL, RFS.20221, SO	12/28/10	HM
		L	ADD PSE CQC, CHANGE LOGO ON LABEL, RFS.21829, SO	11/01/11	HM

1. ELECTRICAL SPECIFICATIONS:

INPUT

INPUT VOLTAGE: 90Vac TO 264Vac
INPUT CURRENT: <1.6A rms AT 90VAC INPUT
INPUT FREQUENCY: 47HZ - 63HZ

OUTPUT :

OUTPUT VOLTAGE: 19.5 VDC
OUTPUT CURRENT: 2.56 A, NO LOAD TO FULL LOAD, NO MINIMUM LOAD REQUIRED
RATED OUTPUT POWER: 50 WATTS, MAXIMUM
OUTPUT REGULATION: +/-5% MEASURED AT THE OUTPUT CONNECTOR
LINE VOLTAGE REGULATION: +/- 1% TYPICAL MEASURED AT FULL LOAD
HIGH FREQ. OUTPUT RIPPLE: 1% OF OUTPUT VOLTAGE, PEAK TO PEAK, TYPICAL
TURN-ON/TURN-OFF OVERSHOOT: 5% MAXIMUM, 1ms TYPICAL RECOVERY TIME FOR 25% STEP LOAD
TURN-ON DELAY: 1 SECOND, TYPICAL
HOLD-UP TIME: 10ms TYPICAL AT NOMINAL INPUT VOLTAGE AND FULL LOAD
INRUSH CURRENT: 20A TYPICAL AT 115Vac INPUT AND 30A TYPICAL AT 230Vac INPUT
SWITCHING FREQUENCY: 100KHZ TYPICAL
EFFICIENCY: 75% TYPICAL AT NOMINAL INPUT AND FULL LOAD
OUTPUT INDICATOR: GREEN LED FOR OUTPUT PRESENT



PROTECTION

OVER-VOLTAGE: VOLTAGE LIMITED TO LESS THAN 130%, CROWBAR METHOD
OVERLOAD: HICCUP MODE WITH AUTO-RECOVERY (110 - 130% OF RATED LOAD)
SHORT CIRCUIT: HICCUP MODE, OUTPUT WILL AUTORECOVER UPON REMOVAL OF SHORT
INPUT PROTECTION: INPUT LINE FUSING

SAFETY

DIELECTRIC WITHSTAND VOLTAGE: 4242Vdc FROM PRIMARY TO SECONDARY
EARTH LEAKAGE CURRENT: 500uA at 264Vac INPUT VOLTAGE

APPROVALS

ITE UNITS: UL 60950 (THIRD EDITION), CUL TO 22.2 NO. 60950, TUV TO EN60950+UL1310, PSE TO J60950, CB REPORT, CCC TO GB4943-2001
EMI: COMPLIES WITH EN55022 CLASS B AND FCC PART 15 CLASS B, VCCI WHEN TESTED WITH RESISTIVE LOAD, BOTH CONDUCTED AND RADIATED EMI.

CE MARK: TESTED TO COMPLY WITH EN61000-3-2 EN61000-3-3 AND EN50082-1 INCLUDING EN61000-4-2, EN61000-4-3, EN61000-4-4, EN61000-4-5, EN61000-4-6, EN61000-4-11.

MTBF: 200,000 HOURS AT 25°C AMBIENT TEMPERATURE

OPERATING TEMPERATURE: 0°C TO 40°C AMBIENT TEMPERATURE

HUMIDITY: 0% TO 90% RELATIVE HUMIDITY

STORAGE TEMPERATURE: - 40°C TO 80°C

ROHS: COMPLIES WITH EU 2002/95/EC AND CHINA SJ/T 11363-2006

Foot Note: Globtek Inc. will not be liable for the safety and performance of these power supplies if unauthorized access and repair occurs. End user should consult applicable UL, CSA or EN standards for proper installation instructions	DASH NO.	PART NO	REV.	DESCRIPTION	NOTES	
	TABULATION BLOCK					
Limitation of Use: Globtek product are not authorized for use as mission critical components in life support, hazardous environment, nuclear or aircraft applications without prior written approval from the CEO of Globtek Inc.	TOLERANCES: DECIMALS ANGULAR .xx +/- 0.1 +/- 1° .xxx +/- .005		 186 Veterans Dr. Northvale, NJ 07647 Tel. 201-784-1000 Fax 201.784.0111 www.globtek.com			
	INIT.BY: DMR	DATE: 04/08/04				MILLIMETERS ANGULAR .xx +/- 0.3 +/- 1° .xxx +/- .013
Contents of this document are subject to change without prior notice	DRAWN: NF	DATE: 04/08/04	FSCN No.: G, Y	SIZE A	MODEL NO: GT-21097-5024-4.5	REV. L
	APRVD : DMR	DATE: 04/08/04	SCALE: NONE		PART NO: GS-741(R)	SHEET 1 OF 5

PROPRIETARY INFORMATION:

PROPRIETARY OF GLOBTEK, INC. ANY REPRODUCTION, DISCLOSURE OR USE OF THIS DRAWING, IN WHOLE OR IN PART, IS HEREBY PROHIBITED EXCEPT AS SPECIFIED IN WRITING BY GLOBTEK, INC.

2. MECHANICAL SPECIFICATION

ENCLOSURE:

UPPER HOUSING: HIGH IMPACT PLASTIC, 94V0 POLYCARBONATE, NON-VENTED, COLOR BLACK

LOWER HOUSING: HIGH IMPACT PLASTIC 94V0 POLYCARBONATE, NON- VENTED, COLOR BLACK

SIZE: 119 x 60 x 32 ± 1 mm

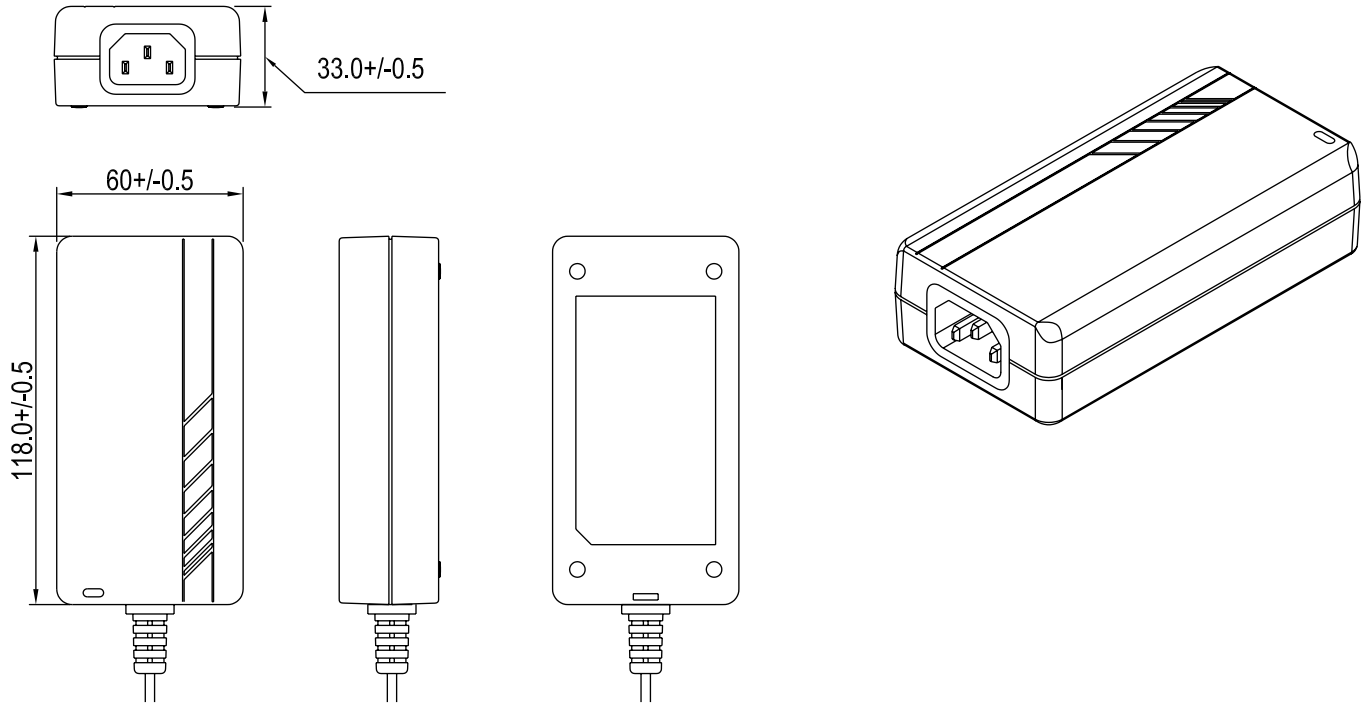

3. INPUT AND OUTPUT CONNECTION

INPUT CONNECTOR:

CONFIGURATION: CLASS II FE MODEL IEC320 / C14, AC POWER RECEPTACLE WITH 3 MALE PRONGS

GlobTek, Inc.
www.globtek.com

186 Veterans Dr. Northvale, NJ 07647
Tel. 201-784-1000 Fax 201.784.0111

DWG TITLE: SWITCHER , 50WATT, 19.5V@ 2.56A SINGLE OUTPUT, DESKTOP
UNIVERSAL INPUT, ITE, CLASS II FE

MODEL NO: GT-21097-5024-4.5

. REV.
L

PART NO: GS-741(R)

SHEET 2 OF 5

PROPRIETARY INFORMATION:
 PROPRIETARY OF GLOBTEK, INC. ANY REPRODUCTION, DISCLOSURE OR USE OF THIS DRAWING, IN WHOLE OR IN PART, IS HEREBY PROHIBITED EXCEPT AS SPECIFIED IN WRITING BY GLOBTEK, INC.

OUTPUT CORD :

1 CONDUCTOR + SHIELD , 18 AWG STRANDED WIRE, ROUND UL # 1185 CORD TYPE, COLOR BLACK, LENGTH (L) OF CORD: 1830 +100,-0 mm. CORD IS MEASURED FROM THE HOUSING TO THE END OF OVERMOLD OF THE CONNECTOR. CABLE IS TO BE MARKED WITH WIRE GAUGE, AND ALL APPLICABLE RATING AND SAFETY APPROVALS.

OUTPUT CONNECTOR:

CUSTOM, 2 x RJ-45 JACK MOUNTED IN 94V-0 POLYCARBONATE ENCLOSURE:

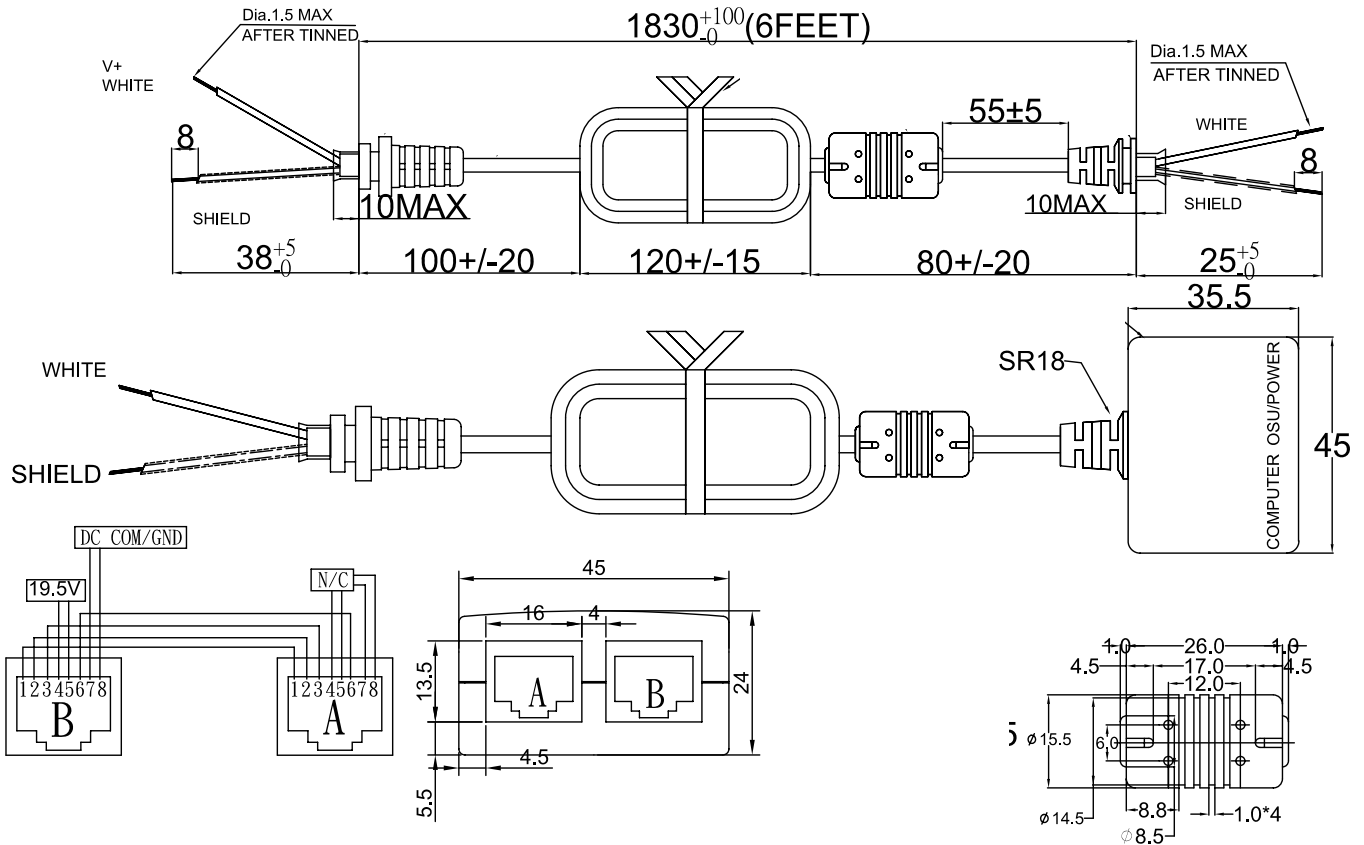

 GlobTek, Inc. www.globtek.com		186 Veterans Dr. Northvale, NJ 07647 Tel. 201-784-1000 Fax 201.784.0111	
DWG TITLE: SWITCHER , 50WATT, 19.5V@ 2.56A SINGLE OUTPUT, DESKTOP UNIVERSAL INPUT, ITE, CLASS II FE			
MODEL NO: GT-21097-5024-4.5			REV. L
PART NO: GS-741(R)			SHEET 3 OF 5

PROPRIETARY INFORMATION:















PROPRIETARY OF GLOBTEK, INC. ANY REPRODUCTION, DISCLOSURE OR USE OF THIS DRAWING, IN WHOLE OR IN PART, IS HEREBY PROHIBITED EXCEPT AS SPECIFIED IN WRITING BY GLOBTEK, INC.

4. LABEL:

MATERIAL: .007 (0.18) THICK FLAT THERMAL TRANSFER, IMPRINTABLE, BLACK POLYESTER SHEET WITH WHITE NOMENCLATURE.
MANUFACTURER: STEVEN LABEL, MATERIAL I.D. NO.3302-33, UL FILE NO. MH12821(N), UL MATERIAL DESIGNATION FILE NO. GHW332RL. OPTIONAL LABEL MATERIAL CAN BE SUBSTITUTED PROVIDING MATERIAL IS UL LISTED AND COMPLIES WITH APPLICABLE SAFETY REQUIREMENTS.

Nokia Siemens Networks 

ITE POWER SUPPLY(开关电源适配器)
PART NO(料号) : GS-741
MODEL(机种名称):GT-21097-5024-4.5
INPUT(输入) : 100-240V~1.6A MAX,50-60Hz
OUTPUT(输出) :+19.5V --- 2.56A
L.P.S.(LIMITED POWER SOURCE)

GT221097-5024-4.5 LEVEL 3  LISTED 8830 US E132594 CLASS 2 POWER UNIT	GT-21097-5024-4.5 LEVEL 3  LISTED 6D44 US E170507 I.T.E. POWER SUPPLY
  	   
 	   AGILENT TECHNOLOGIES

S/N: _____ **RoHS**

MADE IN XXXX (中国制造) 

XXXX - USA OR CHINA

**ACTUAL POSITIONING OF SYMBOLS
AND TEXT IS SUBJECT TO CHANGE
AT TIME OF MANUFACTURE**



CAUTION: FOR INDOOR USE ONLY
ATTENTION: POUR UTILISATION A L'INTERUR SEULAMENT

 GlobTek, Inc. www.globtek.com		186 Veterans Dr. Northvale, NJ 07647 Tel. 201-784-1000 Fax 201.784.0111
DWG TITLE: SWITCHER , 50WATT, 19.5V@ 2.56A SINGLE OUTPUT, DESKTOP UNIVERSAL INPUT, ITE, CLASS II FE		
MODEL NO:	GT-21097-5024-4.5	REV. L
PART NO:	GS-741(R)	SHEET 4 OF 5

PROPRIETARY INFORMATION:

PROPRIETARY OF GLOBTEK, INC. ANY REPRODUCTION, DISCLOSURE OR USE OF THIS DRAWING, IN WHOLE OR IN PART, IS HEREBY PROHIBITED EXCEPT AS SPECIFIED IN WRITING BY GLOBTEK, INC.

5. INDIVIDUAL PACKING BOX:

MATERIAL: CORRUGATED FIBERBOARD, F-FLUTE 0.8 (2.0) THICK, DOUBLE WALL CONSTRUCTION.
EXTERNAL FINISH: WHITE, COATED WITH GLOSS FINISH (AQUEOUS OR VARNISH) STYLE: TUCK SIDES WITH LOCKING TABS ON BOTH SIDES OF BOX. NO PRINTING ON THE OUTSIDE OF BOX.

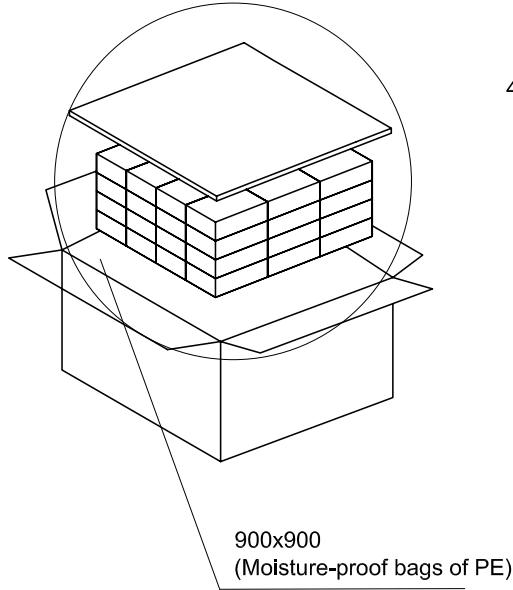

48 PCS/CARTON(12*4)

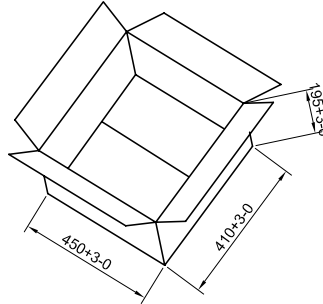

OUTSIDE CARTON

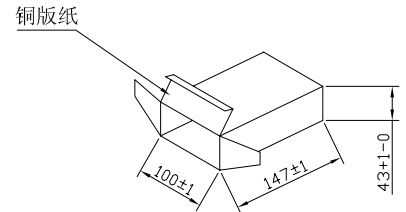

GIFT BOX

147(L)X100(W)X33(H)

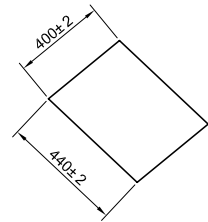

PARTITION

China RoHS SELF DISCLOSURE TABLE

有害有害物质或元素名称及含量标准形式 Name and concentration of hazardous substance or element in product						
零件名 Name of part	剧毒有害物质或元素 Hazardous substance or element					
	铅 Pb	汞 Hg	镉 Cd	六价铬 Cr(VI)	多溴联苯 PBB	多溴二苯醚 PBDE
输出线材料 DC CABLE	X	○	○	○	○	○
输入插座 AC SOCKET	X	○	○	○	○	○
二极管 SMD ZENER	X	○	○	○	○	○
○: 表示该有害有害物质在这部件中所有同质材料中的含量均在SJ/T 11363-2006规定的限量要求以下 ○ refers to the concentration of this hazard substance in the all homogenous materials in this part is below the concentration limit as stipulated in the standard SJ/T 11363-2006.						
X: 表示该有害有害物质至少在这部件中的某一同质材料中的含量超出 SJ/T 11363-2006规定的限量要求。 X: refers to the concentration of this hazard substance at least in a homogenous material is higher than the concentration limit as stipulated in the standard SJ/T 11363-2006.						

GlobTek, Inc. www.globtek.com	186 Veterans Dr. Northvale, NJ 07647 Tel. 201-784-1000 Fax 201.784.0111
	DWG TITLE: SWITCHER , 50WATT , 19.5V@ 2.56A SINGLE OUTPUT, DESKTOP UNIVERSAL INPUT, ITE, CLASS II FE
MODEL NO: GT-21097-5024-4.5	REV. L
PART NO: GS-741(R)	SHEET 5 OF 5