



# TAOGLAS®



# Datasheet

## DSGP.1575.18.4.A.02

### Description:

GPS L1 / GALILEO E1 1575.42MHz 18\*18\*4mm Ceramic Patch SMD Antenna

### Features:

4.20 dBi Peak Gain for GPS/GALILEO Band  
Dimensions: 18 x 18 x 4mm  
SMD Direct Mount Ceramic Patch Antenna  
TS16949 Approved  
RoHS & Reach Compliant

1. Introduction	3
2. Specifications	4
3. Antenna Characteristics	6
4. Radiation Patterns	8
5. Mechanical Drawing	10
6. Antenna Integration Guide	11
7. Evaluation Board Mechanical Drawing	16
8. PCB Footprint Recommendation	17
9. Recommended Solder Reflow	19
10. Packaging	20
Changelog	22

Taoglas makes no warranties based on the accuracy or completeness of the contents of this document and reserves the right to make changes to specifications and product descriptions at any time without notice. Taoglas reserves all rights to this document and the information contained herein. Reproduction, use or disclosure to third parties without express permission is strictly prohibited.



## 1. Introduction



The DSGP.1575.18.4.A.02 is a ceramic GPS L1 / GALILEO E1 passive patch antenna, 18mm square, with a low profile of 4mm thickness. It is designed for applications in space constrained navigation devices, vehicle tracking/fleet management systems, as well as telematics devices.

The antenna has been tuned on a 50 x 50 mm ground plane, working at 1575.42MHz with a 4.20 dBi gain. The ceramic patch is mounted via SMT process, ideal for high volume low cost assembly. It is manufactured and tested in a TS16949 first tier automotive approved facility.

For further optimization to customer specific device environments where ground-plane size is different, custom tuned patch antennas can be supplied. For more details please contact your regional Taoglas sales office.

## 2. Specifications

GNSS Frequency Bands Covered							
<b>GPS/QZSS</b>	L1 1575.42MHz	L2 1227.6MHz	L5 1176.45MHz	L6 1278.75MHz			
	<input checked="" type="checkbox"/>	<input type="checkbox"/>	<input type="checkbox"/>	<input type="checkbox"/>			
<b>GLONASS</b>	L5R 1176.45MHz	L3PT 1201.5MHz	L2PT 1246MHz	L1CR 1575.42MHz	L1PT 1602MHz		
	<input type="checkbox"/>	<input type="checkbox"/>	<input type="checkbox"/>	<input checked="" type="checkbox"/>	<input type="checkbox"/>		
<b>Galileo</b>	E5a 1176.45MHz	E5b 1201.5MHz	E4 1215MHz	E3 1256MHz	E6 1278.75MHz	E2 1561MHz	L1 1575.42MHz
	<input type="checkbox"/>	<input type="checkbox"/>	<input type="checkbox"/>	<input type="checkbox"/>	<input type="checkbox"/>	<input type="checkbox"/>	<input checked="" type="checkbox"/>
<b>BeiDou</b>	B1 1561MHz	B2 1207.14MHz	B3 1268.52MHz				
	<input type="checkbox"/>	<input type="checkbox"/>	<input type="checkbox"/>				
<b>Compass</b>	E5B(B2)/ E6(B3) 1268.56MHz	E2(B1) 1561MHz					
	<input type="checkbox"/>	<input type="checkbox"/>					
<b>SBAS</b>	Omnistar 1542.5MHz	WAAS/EGN OS 1575.42MHz					
	<input type="checkbox"/>	<input checked="" type="checkbox"/>					

<b>Electrical</b>	
Frequency (MHz)	1575.42
VSWR (max.)	2.0:1
Passive Antenna Efficiency (%)	83.33
Passive Antenna Gain at Zenith (dBi)	4.20
Return Loss (dB)	<-10
Impedance	50Ω
<b>Mechanical</b>	
Dimension	18 x 18 x 4mm
Weight	5.8g
<b>Environmental</b>	
Operation Temperature	-40°C to 85°C
Humidity	Non-condensing 65°C 95% RH
Moisture Sensitivity Level (MSL)	3 (168 Hours)

### 3. Antenna Characteristics

#### 3.1 Return Loss

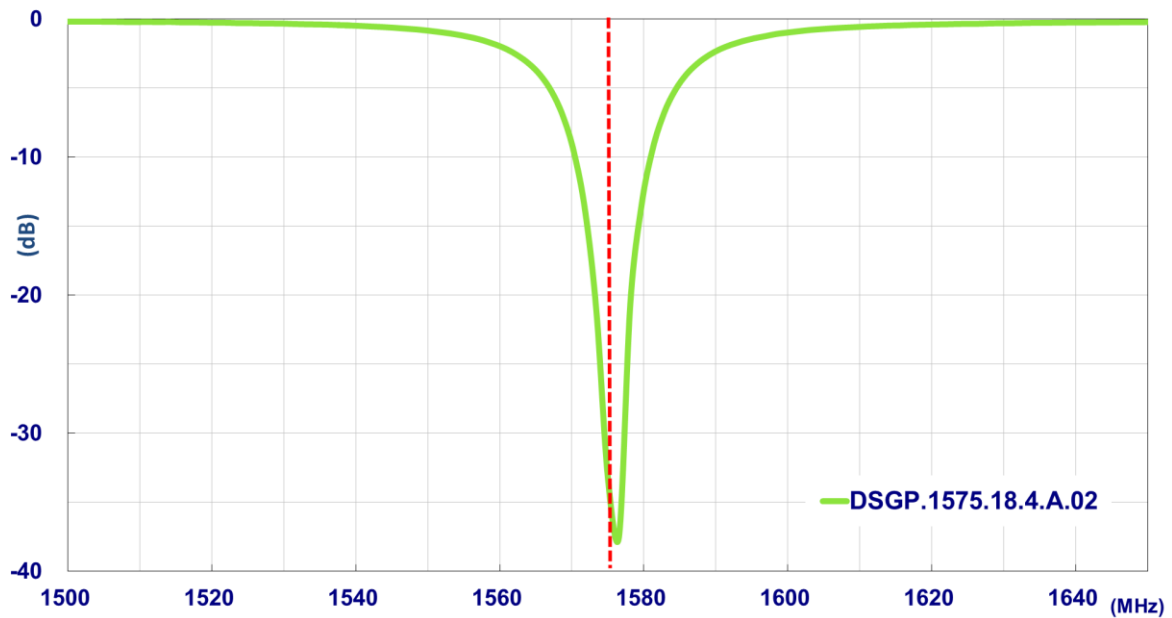

#### 3.2 Efficiency

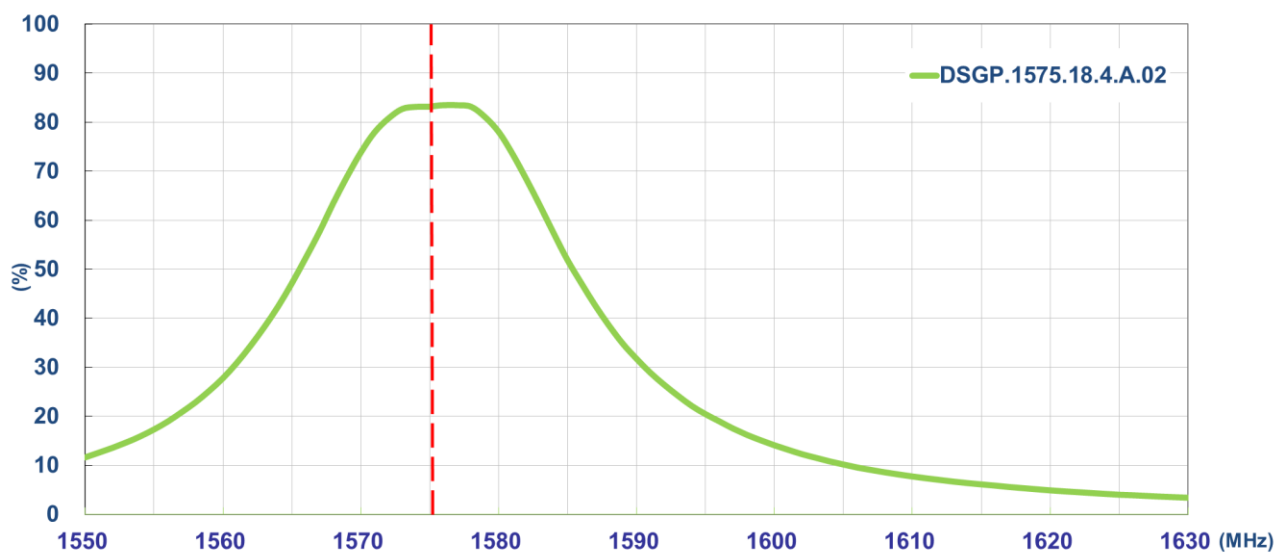

### 3.3 Average Gain

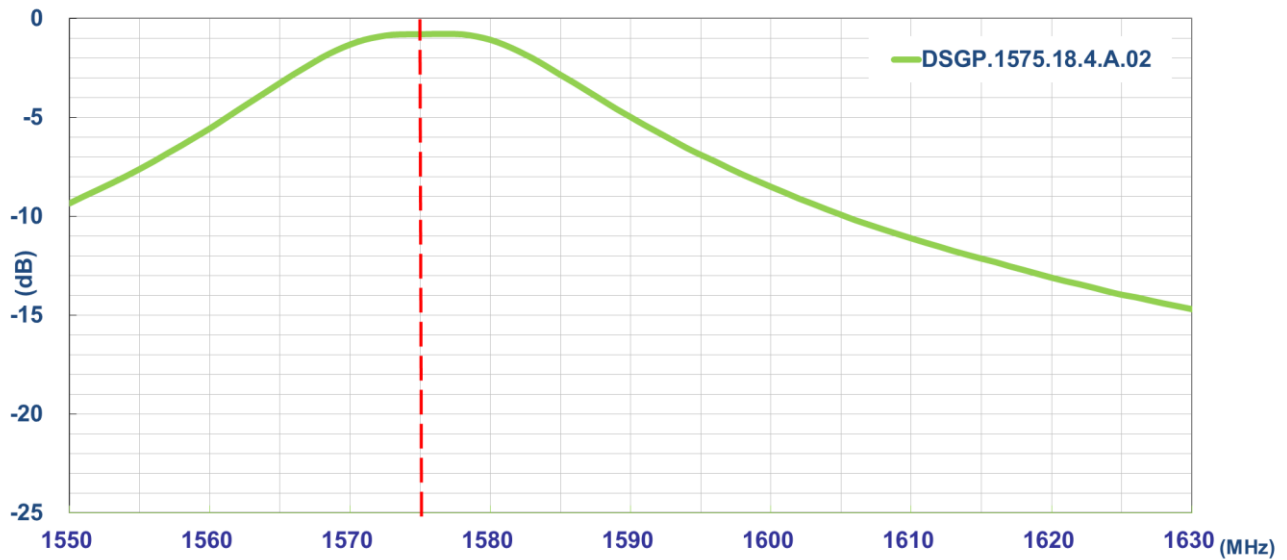

### 3.4 Peak Gain

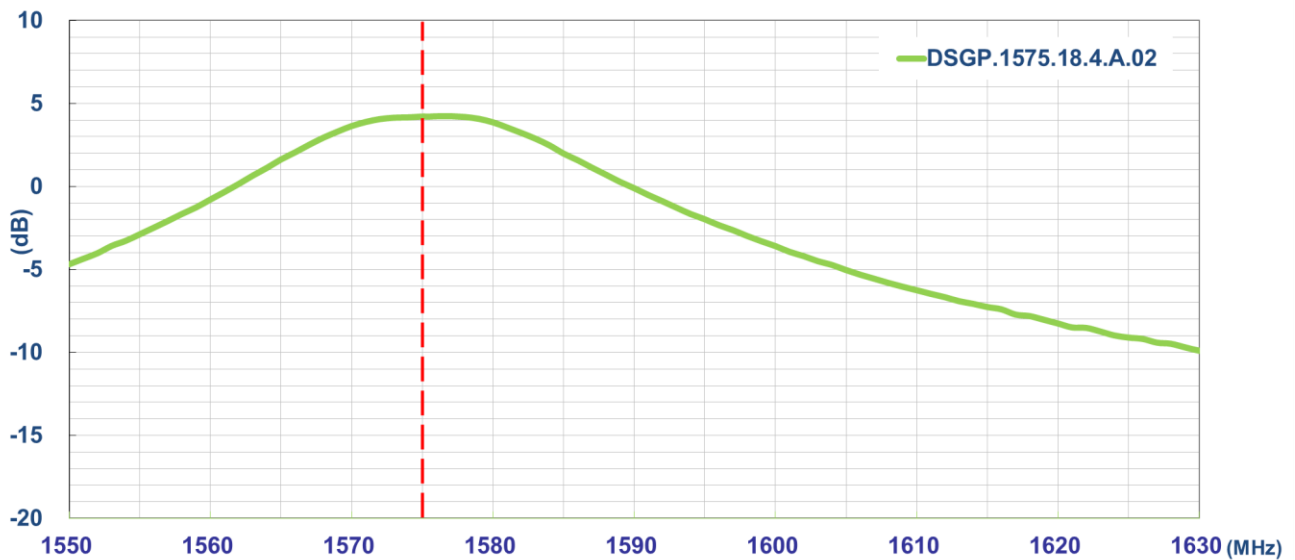

## 4. Radiation Patterns

### 4.1 Test Setup

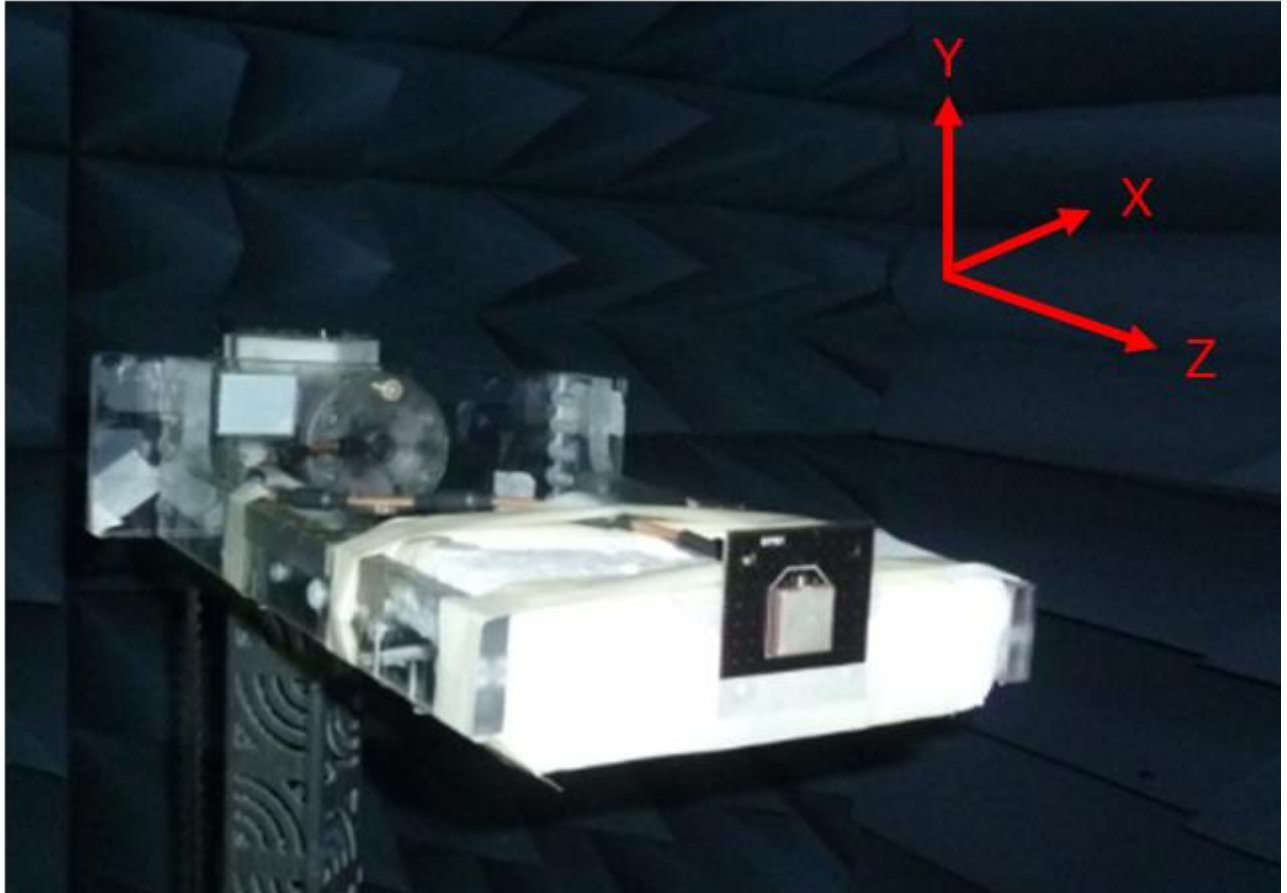

On Evaluation Board

Taoglas Part number: DSGPD.18A



4.2 1575.42MHz 3D and 2D Radiation Patterns

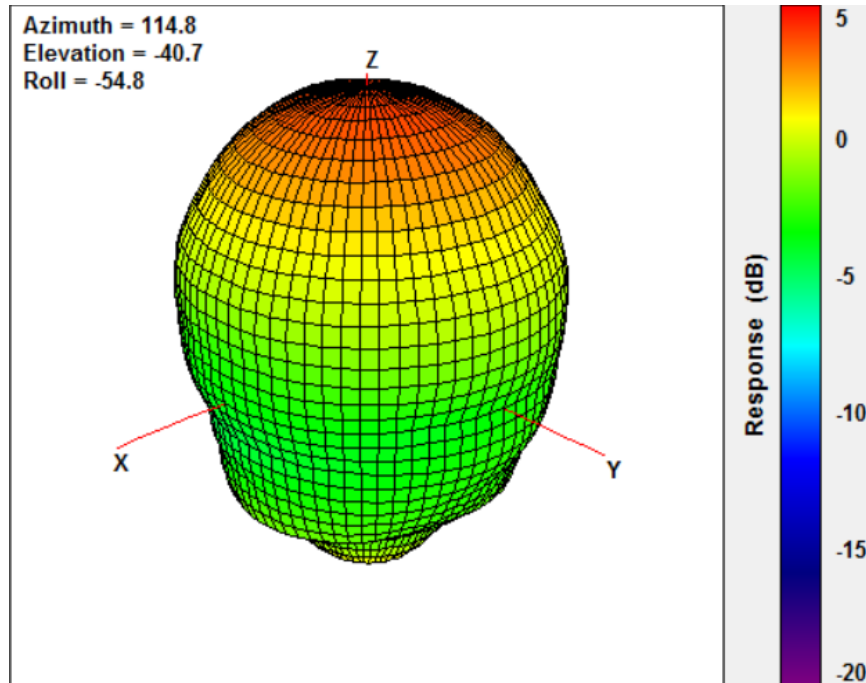

XY Plane

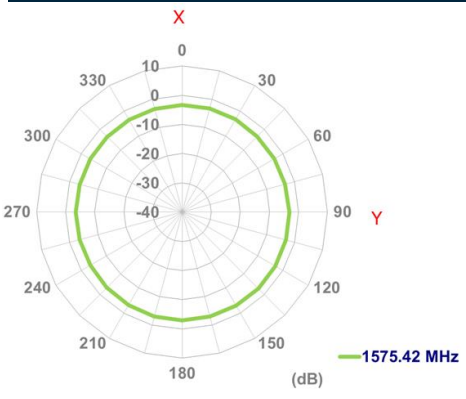

XZ Plane

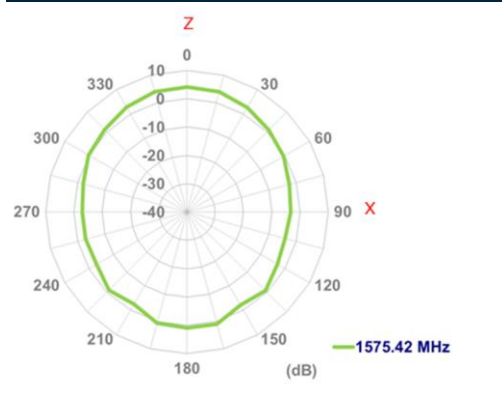

YZ Plane

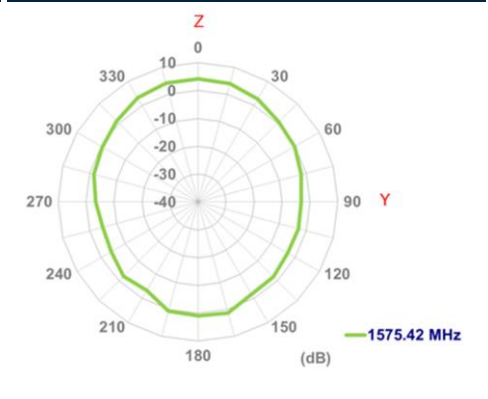

## 5. Mechanical Drawing (Units: mm)

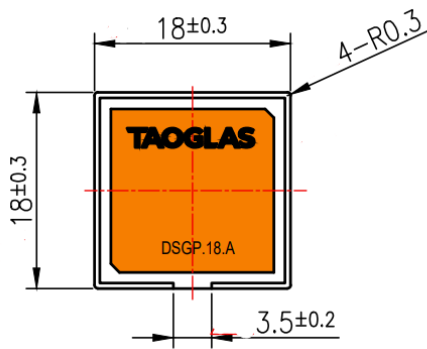

Top View

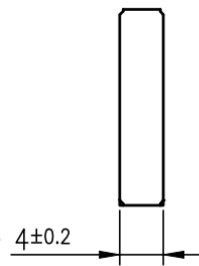

Side View

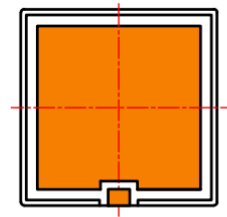

Bottom View

## 6. Antenna Integration Guide

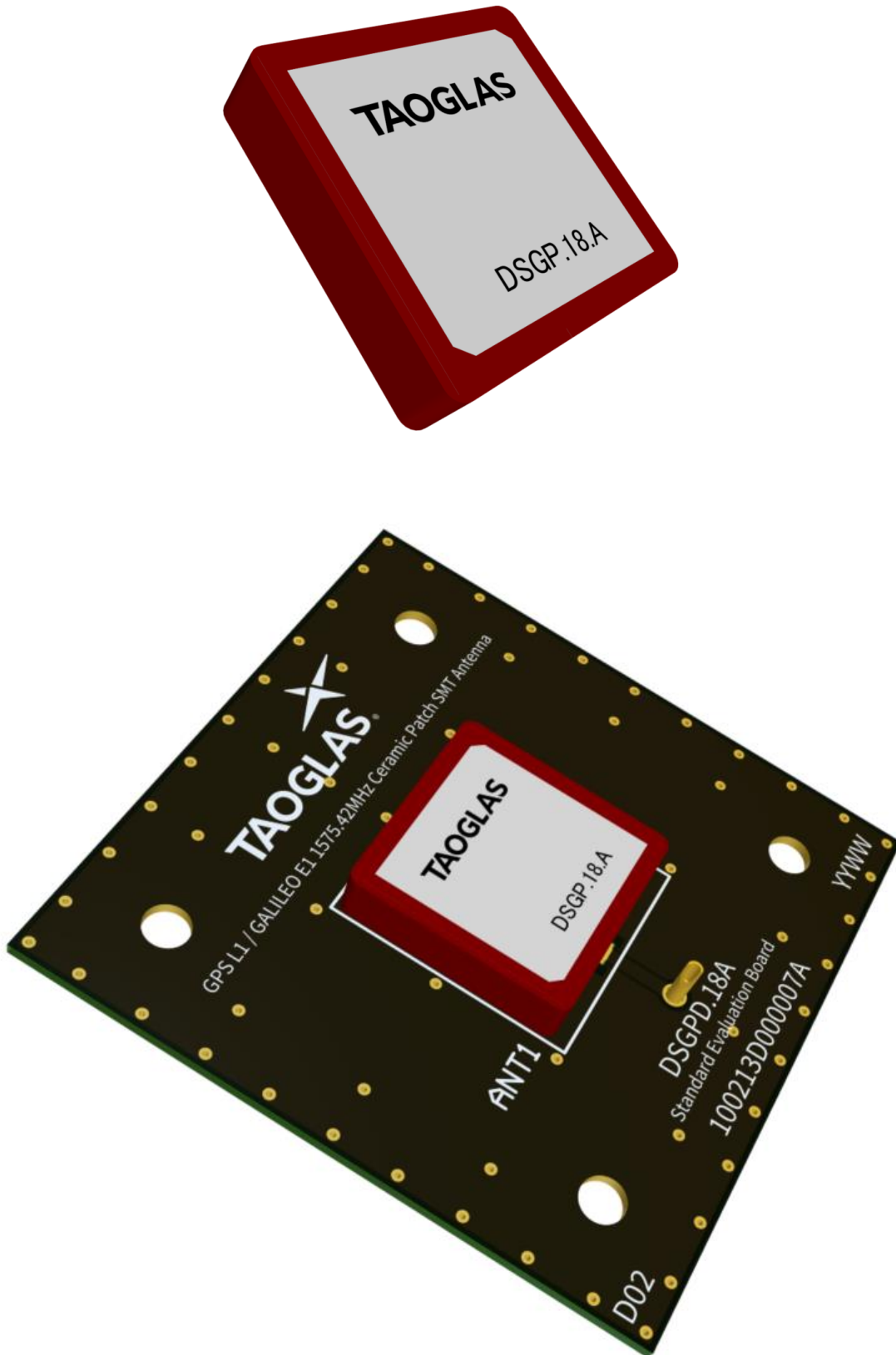

## 6.1 Schematic Symbol and Pin Definition

The circuit symbol for the antenna is shown below. The antenna has 8 pins with all as functional.

Pin	Description
1	RF Feed
2, 3, 4, 5, 6, 7, 8	Ground

DSGP.1575.18.4.A.02  
ANT1

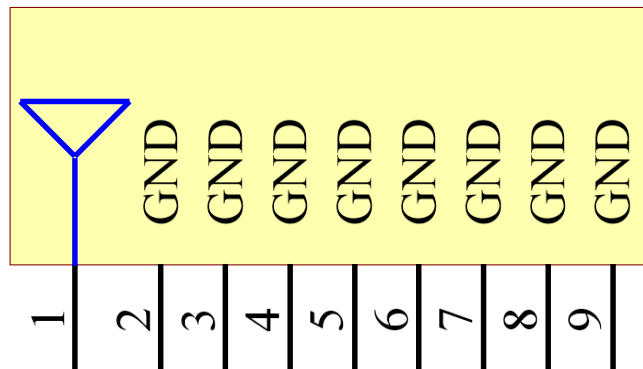

## 6.2 Antenna Integration

The antenna should be placed at the center of the ground plane with a length and width of 50mm. Maintaining a square symmetric ground plane shape and symmetric environment around the antenna is critical to maintaining the excellent axial ratio and phase center performance shown in this datasheet.



Top Side w/ Solder Mask

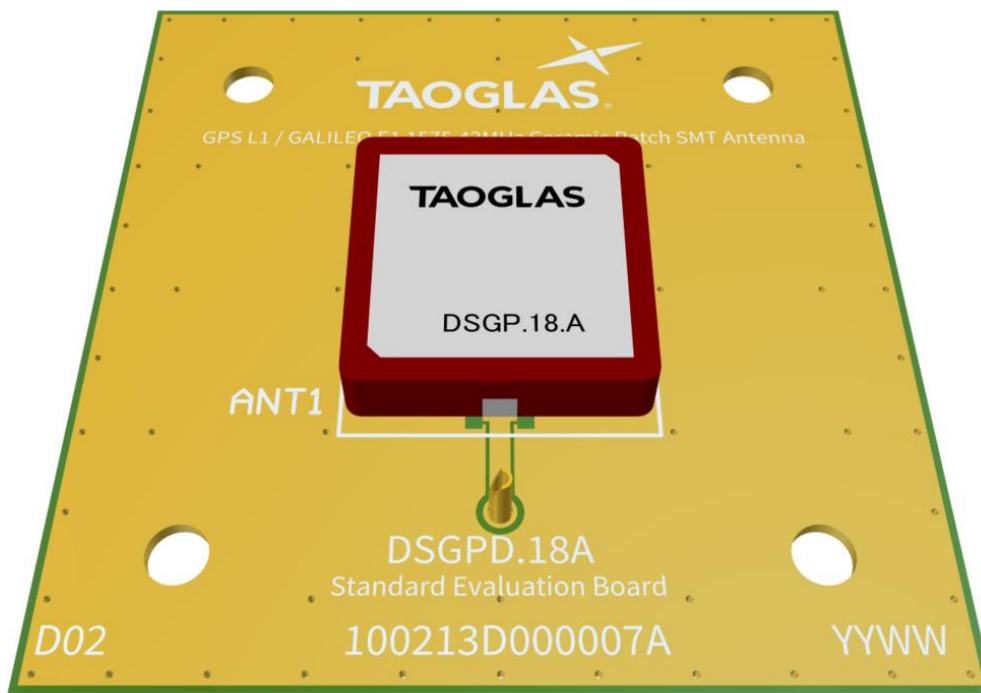

Top Side w/o Solder Mask

## 6.3 PCB Layout

The footprint and clearance on the PCB must comply with the antenna specification. The PCB layout shown in the diagram below demonstrates the antenna footprint.

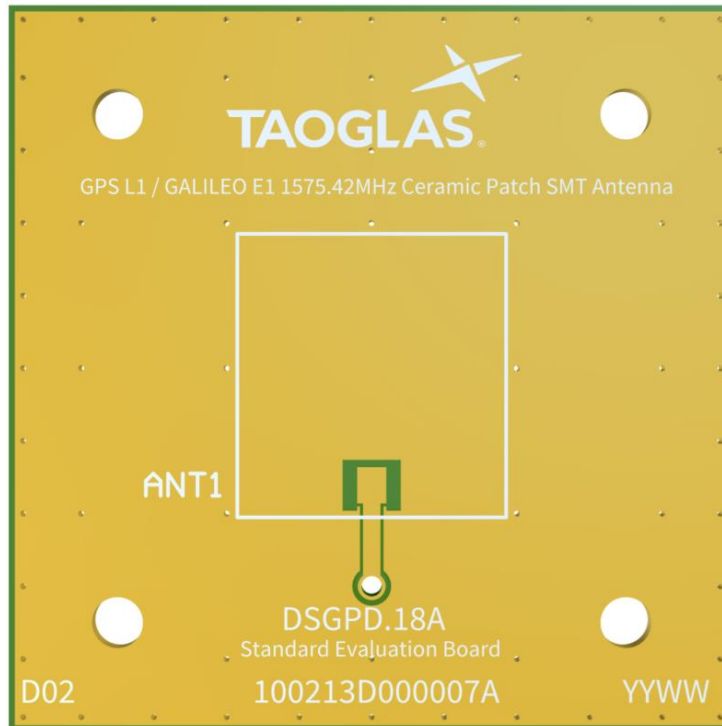

Topside

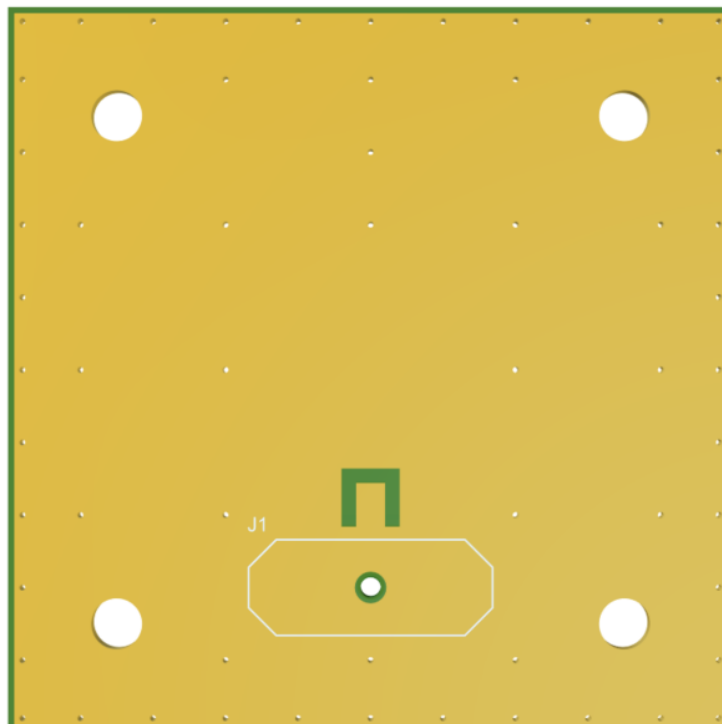

Bottom Side

6.4 Evaluation Board

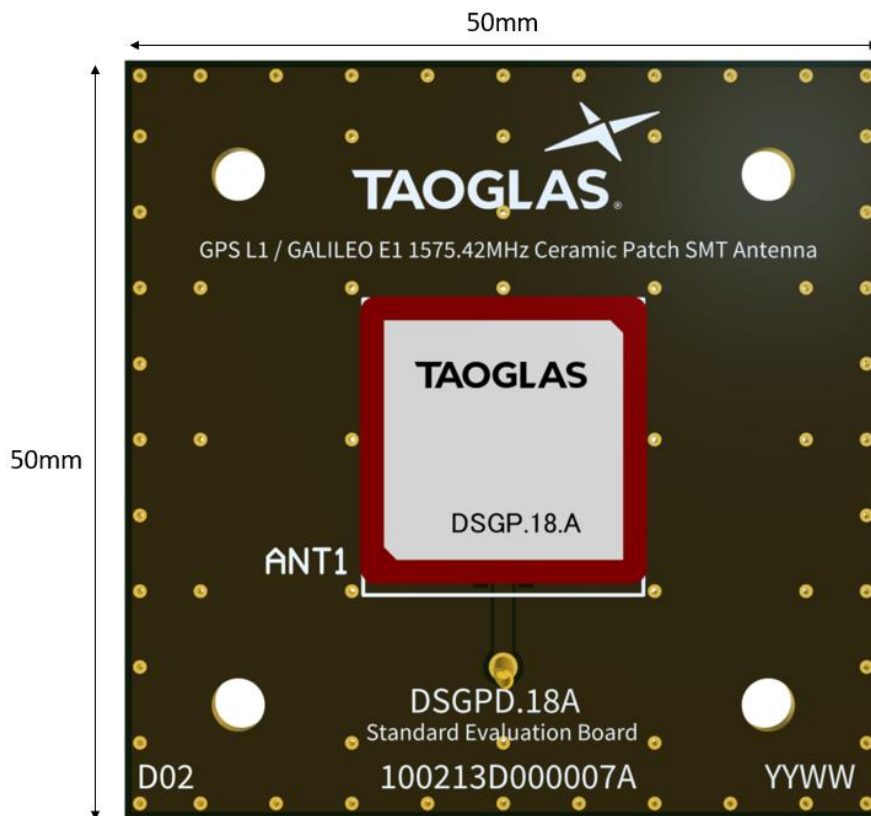

Topside

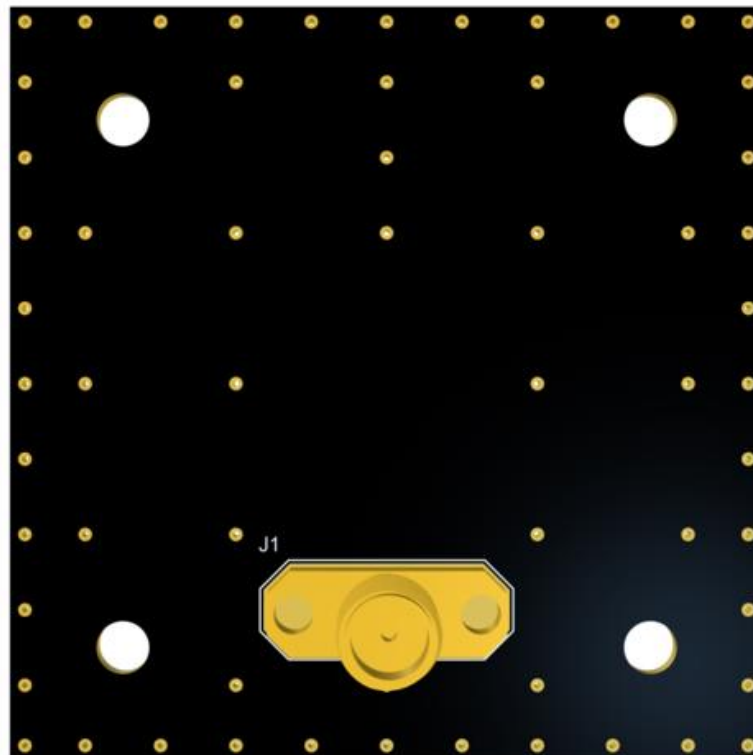

Bottom Side

# 7. Evaluation Board Mechanical Drawing

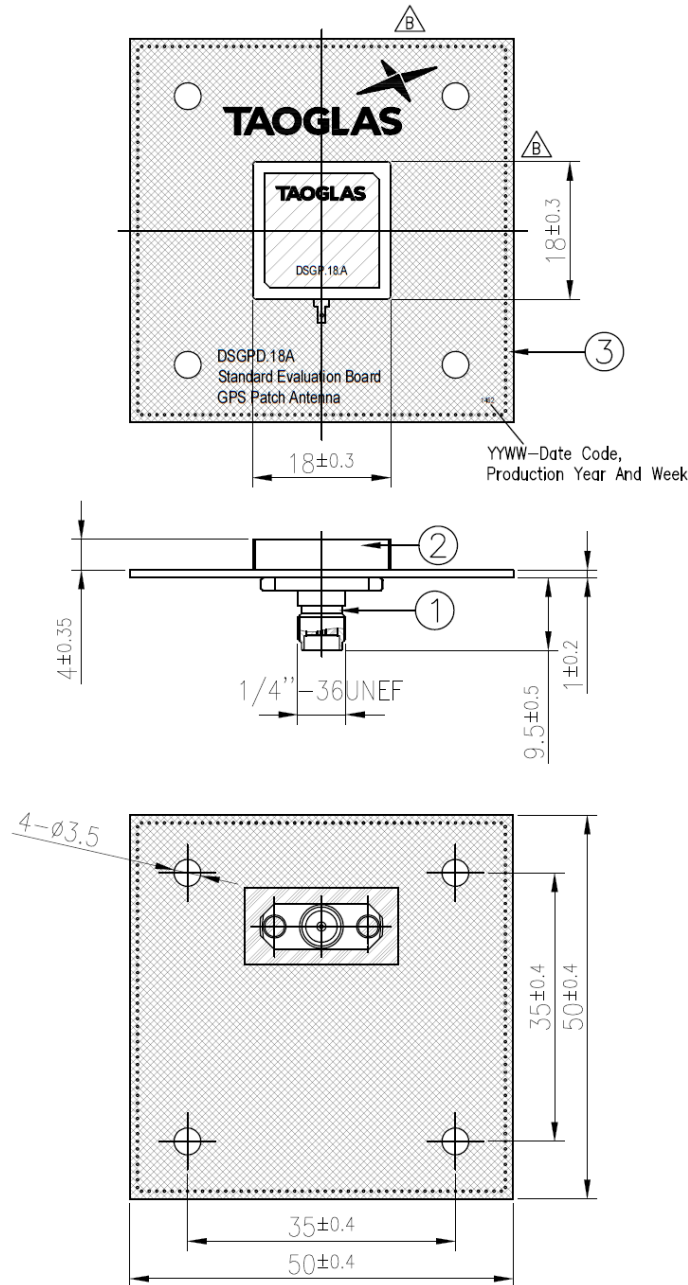

### Notes

- 1. Silver area
- 2. Solder mask
- 3. Solder Area





	Name	P/N	Material	Finish	QTY
1	PCB SMA(F) ST	200411I000007A	FR4	Au Plated	1
2	DSGP.1575.18.4.A.02 Antenna	001514L060007A	Ceramic	Clear	1
3	PCB (50x50x1mm)	100213D000007A	FR4 1.0t	Black	1

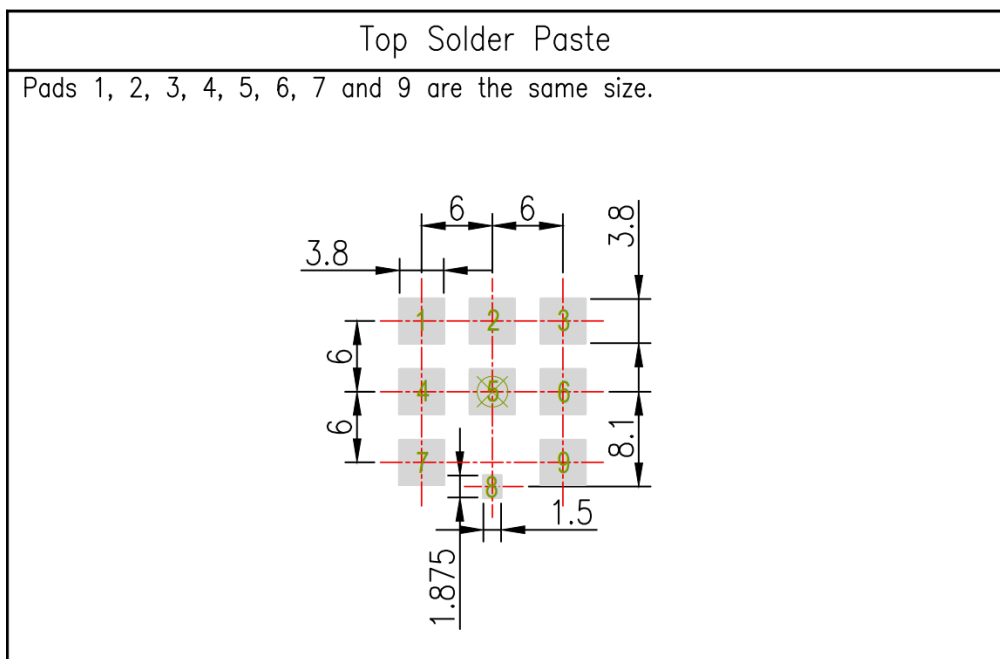
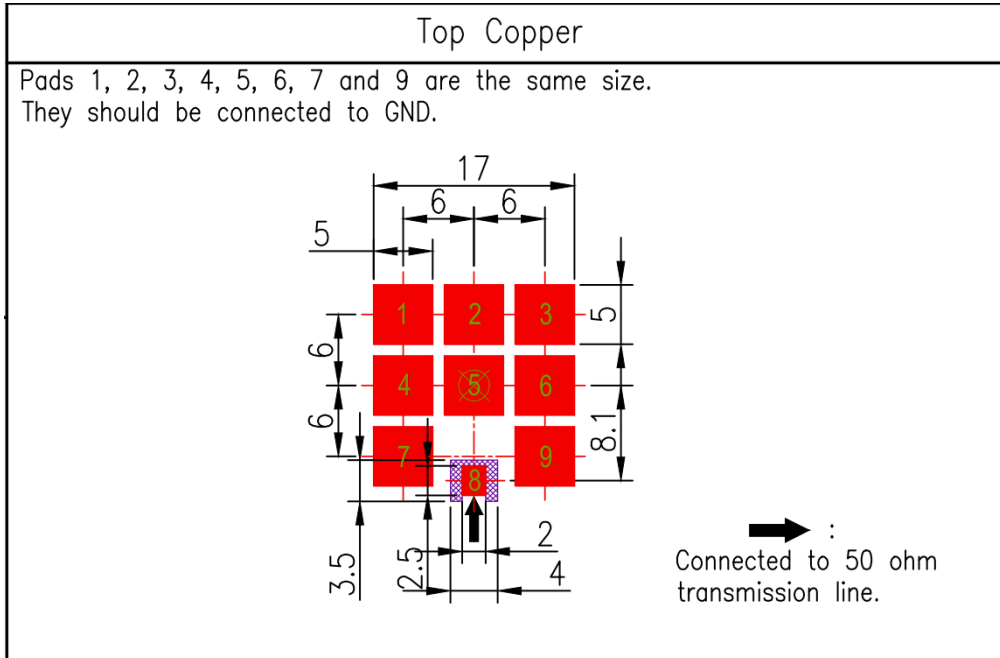

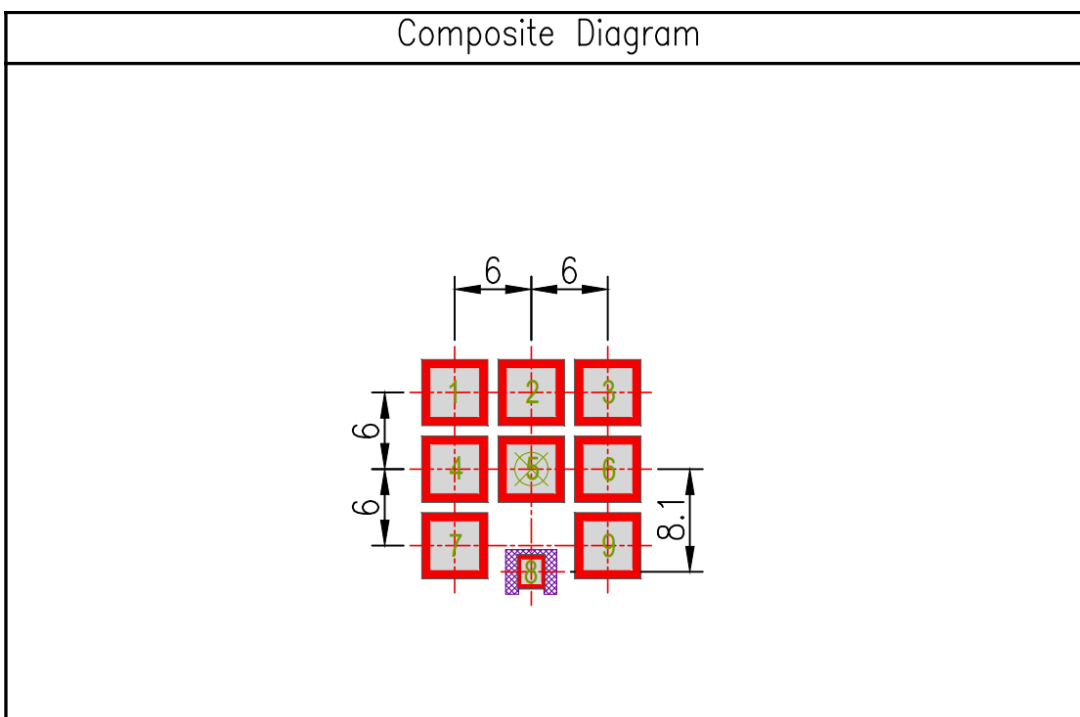
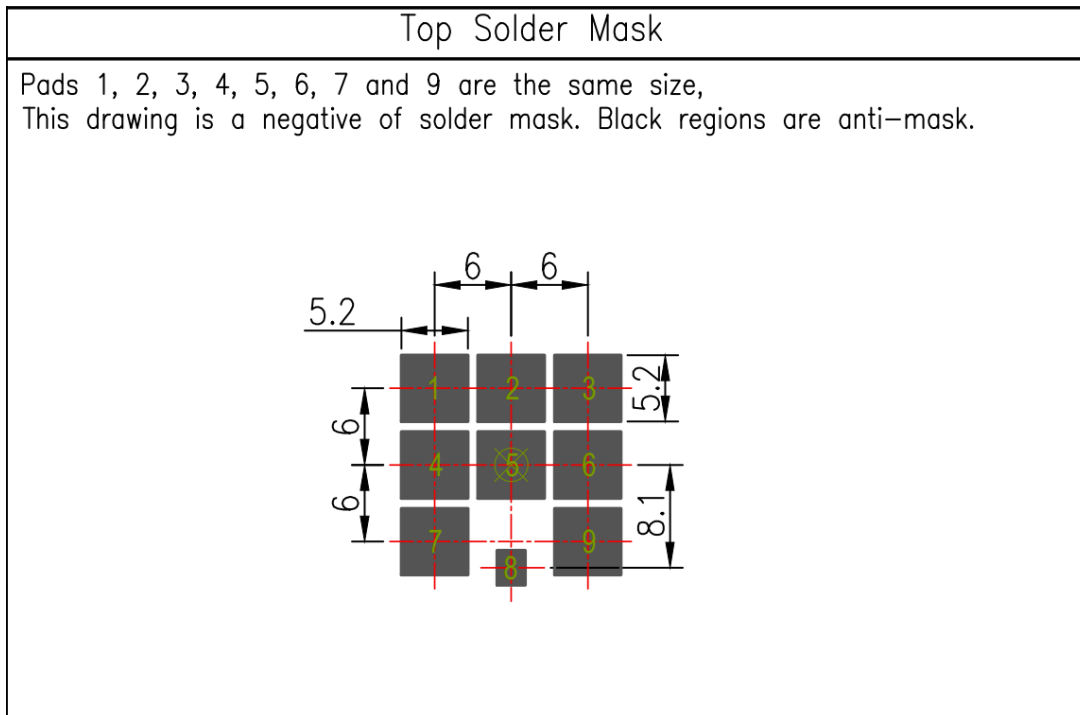
## 8. PCB Footprint Recommendation





- NOTE:
- |                        |   |   |
|------------------------|---|---|
| 1. Ag Plated area      |  | 6. Copper keepout should extend through all PCB layers.   |
| 2. Solder Mask area    |  | 7. Any vias in pads should be either filled or tented to prevent solder from wicking away from the pad during reflow. |
| 3. Copper area         |  |   |
| 4. Paste area          |  |   |
| 5. Copper Keepout Area |  | 8. The dimension tolerances should follow standard PCB manufacturing guidelines                                       |

## 9. Recommended Reflow Soldering Profile

DSGP.1575.18 can be assembled following Pb-free assembly. According to the Standard IPC/JEDEC J-STD-020C, the temperature profile suggested is as follows:

Phase	Profile Features	Pb-Free Assembly (SnAgCu)
PREHEAT	Temperature Min (T <sub>smin</sub> )	150°C
	Temperature Max (T <sub>smax</sub> )	200°C
	Time(ts) from (T <sub>smin</sub> to T <sub>smax</sub> )	60-120 seconds
RAMP-UP	Avg. Ramp-up Rate (T <sub>smax</sub> to TP)	3°C/second(max)
REFLOW	Temperature (TL)	217°C
	Total Time above TL (t <sub>L</sub> )	30-100 seconds
PEAK	Temperature (TP)	260°C
	Time(tp)	2-5 seconds
RAMP-DOWN	Rate	3°C/second(max)
	Time from 25°C to Peak Temperature	8 minutes max.
	Composition of solder paste	96.5Sn/3Ag/0.5Cu
	Solder Paste Model	SHENMAO PF606-P26

The graphic shows temperature profile for component assembly process in reflow ovens

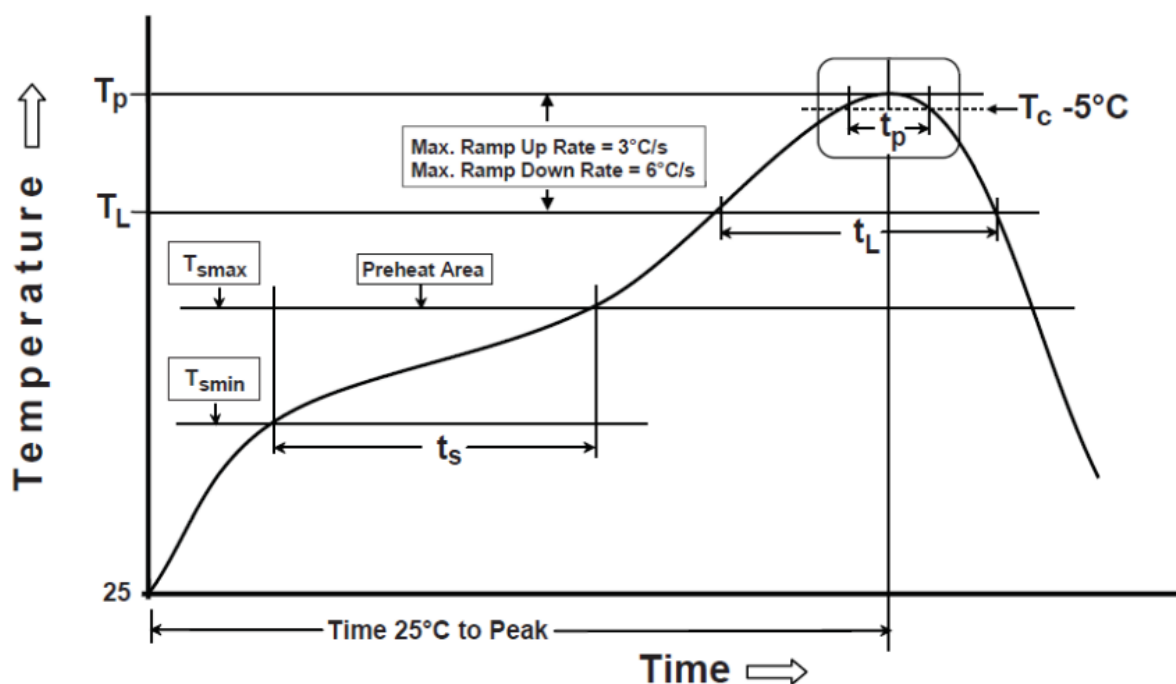

Soldering Iron condition : Soldering iron temperature 270°C±10°C.

Apply preheating at 120°C for 2-3 minutes. Finish soldering for each terminal within 3 seconds, if soldering iron temperature over 270°C±10°C or 3 seconds, it will make cause component surface peeling or damage.

# 10. Packaging

## Packaging Specifications (1/2)

200 pc DSGP.1575.18.4.A.02 per reel  
 Dimensions - Ø330\*50mm  
 Weight - 1556.5g

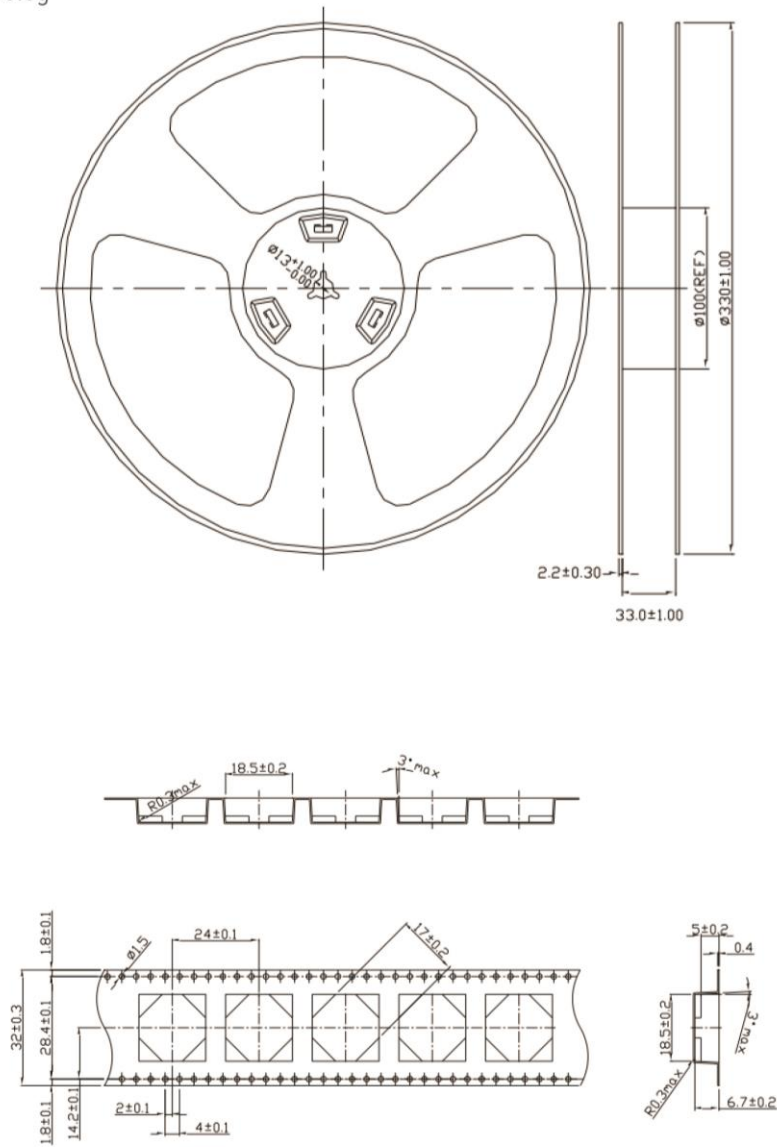

1 pc reel in small in Anti-static Bag  
 Dimensions - 340\*350\*70mm  
 Weight - 1.86Kg

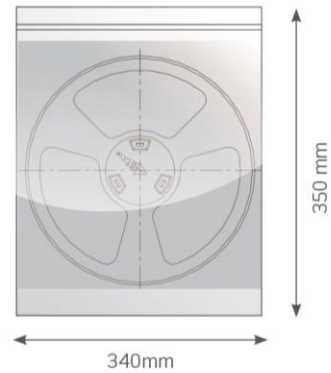

4 Reels in Anti-static Bags  
 800 pcs in one carton  
 Carton Dimensions - 370\*360\*305mm  
 Weight - 8.2Kg

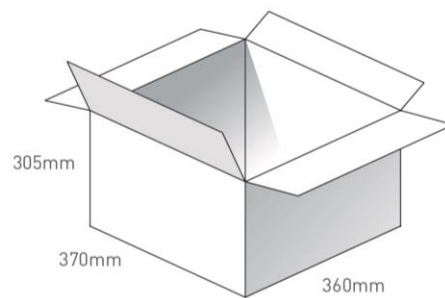

Pallet Dimensions 1200\*1000\*1420mm  
 24 Cartons per Pallet  
 6 Cartons per layer  
 4 Layers

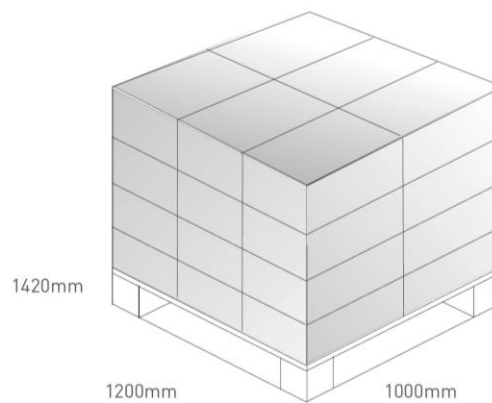

Changelog for the datasheet

**SPE-17-8-030 – DSGP.1575.18.4.A.02**

<b>Revision: C (Current Version)</b>	
Date:	2023-03-24
Changes:	Antenna Integration Guide Added
Changes Made by:	Cesar Sousa

**Previous Revisions**

<b>Revision: B</b>	
Date:	2018-12-18
Changes:	Updated Specifications
Changes Made by:	Jack Conroy

<b>Revision: A (Original First Release)</b>	
Date:	2017-05-22
Notes:	
Author:	Jack Conroy



**TAOGLAS®**

[www.taoglas.com](http://www.taoglas.com)

