

## Data sheet | Item number: 285-184

2-conductor through terminal block; 95 mm<sup>2</sup>; lateral marker slots; with fixing flanges; POWER CAGE CLAMP; 95,00 mm<sup>2</sup>; blue

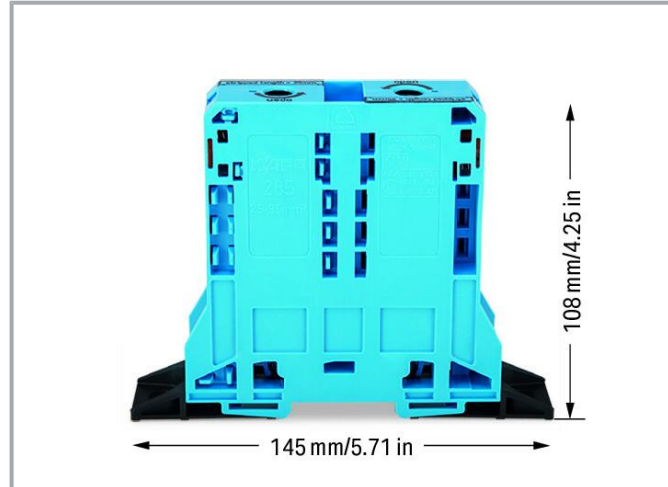

[www.wago.com/285-184](http://www.wago.com/285-184)



### Data

#### Electrical data

#### Ratings per IEC/EN

Ratings per	IEC/EN 60947-7-1
Nominal voltage (III/3)	1000 V
Rated impulse voltage (III/3)	12 kV
Rated current	232 A
Legend (ratings)	(III / 3) ≙ Overvoltage category III / Pollution degree 3

#### Ratings per IEC/EN 2

Rated voltage (III/3) 2	1500 V
Rated surge voltage (III/3) 2	12 kV

Subject to changes. Please also observe the further product documentation!

WAGO GmbH & Co. KG  
Hansastr. 27  
32423 Minden  
Phone: +49571 887-0 | Fax: +49571 887-169  
Email: [info.de@wago.com](mailto:info.de@wago.com) | Web: [www.wago.com](http://www.wago.com)

Do you have any questions about our products?  
We are always happy to take your call at +49 (571) 887-44222.



## Ratings per UL 1059

Approvals per	UL 1059
Rated voltage UL (Use Group B)	600 V
Rated current UL (Use Group B)	200 A
Rated voltage UL (Use Group C)	600 V
Rated current UL (Use Group C)	200 A

## Ratings per CSA

Approvals per	CSA 22.2 No 158
Rated voltage CSA (Use Group B)	1000 V
Rated current CSA (Use Group B)	210 A
Rated voltage CSA (Use Group C)	1000 V
Rated current CSA (Use Group D)	210 A

## Power loss

Power loss, per pole (potential)	7.535 W
Rated current $I_N$ for specified power loss	232 A
Resistance value for specified, current-dependent power loss	0 $\Omega$

## General

Voltage type 1	AC/DC
Voltage type 2	DC

## Connection data

Connection points	2
Total number of potentials	1
Number of levels	1
Number of jumper slots	2

## Connection 1

Connection technology	POWER CAGE CLAMP
Actuation type	T-wrench; 8 mm
Connectable conductor materials	Copper
Solid conductor	25 ... 95 mm <sup>2</sup> / 4 ... 4/0 AWG

Subject to changes. Please also observe the further product documentation!



Stranded conductor	25 ... 95 mm <sup>2</sup> / 4 ... 4/0 AWG
Fine-stranded conductor	25 ... 95 mm <sup>2</sup> / 4 ... 4/0 AWG
Fine-stranded conductor; with insulated ferrule	25 ... 95 mm <sup>2</sup> / 4 ... 4/0 AWG
Fine-stranded conductor; with uninsulated ferrule	25 ... 95 mm <sup>2</sup> / 4 ... 4/0 AWG
Strip length	35 mm / 1.38 inches
Wiring direction	Side-entry wiring

### Physical data

Width	25 mm / 0.984 inches
Height from the surface	108 mm / 4.252 inches
Depth	145 mm / 5.709 inches

### Mechanical Data

Mounting type	Mounting flange
Marking level	Side marking

### Material Data

Note (material data)	Information on material specifications can be found here
Color	blue
Material group	I
Insulation material	Polyamide (PA66)
Flammability class per UL94	V0
Fire load	3.754 MJ
Weight	267.1 g

### Environmental requirements

Processing temperature	-35 ... +85 °C
Continuous operating temperature	-60 ... +105 °C

### Commercial data

eCl@ss 10.0	27-14-11-20
eCl@ss 9.0	27-14-11-20
ETIM 8.0	EC000897
ETIM 7.0	EC000897
PU (SPU)	5 pcs

Subject to changes. Please also observe the further product documentation!





Packaging type	box
Country of origin	PL
GTIN	4055143583947
Customs tariff number	85369010000

## Environmental Product Compliance



RoHS Compliance Status	Compliant, No Exemption
------------------------	-------------------------

## Approvals / Certificates

### General approvals

Logo	Approval	Additional Approval Text	Certificate name
	CCA DEKRA Certification B.V.	EN 60947	NTR NL-7707
	CSA DEKRA Certification B.V.	C22.2	154112
	KEMA/KEUR DEKRA Certification B.V.	EN 60947	71-105562
	UL Underwriters Laboratories Inc.	UL 1059	E45172

### Declarations of conformity and manufacturer's declarations



Logo	Approval	Additional Approval Text	Certificate name
	EU-Declaration of Conformity WAGO GmbH & Co. KG	-	-
	UK-Declaration of Conformity WAGO GmbH & Co. KG	-	-

### Approvals for marine applications

Subject to changes. Please also observe the further product documentation!

WAGO GmbH & Co. KG  
Hansastr. 27  
32423 Minden  
Phone: +49571 887-0 | Fax: +49571 887-169  
Email: [info.de@wago.com](mailto:info.de@wago.com) | Web: [www.wago.com](http://www.wago.com)

Do you have any questions about our products?  
We are always happy to take your call at +49 (571) 887-44222.

Logo	Approval	Additional Approval Text	Certificate name
	<b>ABS</b> American Bureau of Shipping	EN 60947	20- HG1941090- PDA
	<b>DNV GL</b> Det Norske Veritas, Germanischer Lloyd	-	TAE00001V2

## Optional accessories

### Marking accessories

#### Marker carrier



**Item no.: 285-442**  
Adaptor; gray

[www.wago.com/285-442](http://www.wago.com/285-442)

#### Marker



**Item no.: 2009-115/000-002**  
WMB-Inline; for Smart Printer; 1500 pieces on roll; stretchable 5 - 5.2 mm; plain; snap-on type; yellow

[www.wago.com/2009-115/000-002](http://www.wago.com/2009-115/000-002)



**Item no.: 2009-115/000-007**  
WMB-Inline; for Smart Printer; 1500 pieces on roll; stretchable 5 - 5.2 mm; plain; snap-on type; gray

[www.wago.com/2009-115/000-007](http://www.wago.com/2009-115/000-007)



**Item no.: 2009-115/000-017**  
WMB-Inline; for Smart Printer; 1500 pieces on roll; stretchable 5 - 5.2 mm; plain; snap-on type; light green

[www.wago.com/2009-115/000-017](http://www.wago.com/2009-115/000-017)



**Item no.: 2009-115/000-023**  
WMB-Inline; for Smart Printer; 1500 pieces on roll; stretchable 5 - 5.2 mm; plain; snap-on type; green

[www.wago.com/2009-115/000-023](http://www.wago.com/2009-115/000-023)



**Item no.: 2009-115/000-024**  
WMB-Inline; for Smart Printer; 1500 pieces on roll; stretchable 5 - 5.2 mm; plain; snap-on type; violet

[www.wago.com/2009-115/000-024](http://www.wago.com/2009-115/000-024)



**Item no.: 2009-115**  
WMB-Inline; for Smart Printer; 1500 pieces on roll; stretchable 5 - 5.2 mm; plain; snap-on type; white

[www.wago.com/2009-115](http://www.wago.com/2009-115)



**Item no.: 793-5501/000-007**  
WMB marking card; as card; for terminal block width 5 - 17.5 mm; stretchable 5 - 5.2 mm; plain; snap-on type; gray

[www.wago.com/793-5501/000-007](http://www.wago.com/793-5501/000-007)

Subject to changes. Please also observe the further product documentation!



**Item no.:** 793-5501/000-012

WMB marking card; as card; for terminal block width 5 - 17.5 mm; stretchable 5 - 5.2 mm; plain; snap-on type; orange

[www.wago.com/793-5501/000-012](http://www.wago.com/793-5501/000-012)



**Item no.:** 793-5501/000-014

WMB marking card; as card; for terminal block width 5 - 17.5 mm; stretchable 5 - 5.2 mm; plain; snap-on type; brown

[www.wago.com/793-5501/000-014](http://www.wago.com/793-5501/000-014)



**Item no.:** 793-5501/000-017

WMB marking card; as card; for terminal block width 5 - 17.5 mm; stretchable 5 - 5.2 mm; plain; snap-on type; light green

[www.wago.com/793-5501/000-017](http://www.wago.com/793-5501/000-017)



**Item no.:** 793-5501/000-023

WMB marking card; as card; for terminal block width 5 - 17.5 mm; stretchable 5 - 5.2 mm; plain; snap-on type; green

[www.wago.com/793-5501/000-023](http://www.wago.com/793-5501/000-023)



**Item no.:** 793-5501/000-024

WMB marking card; as card; for terminal block width 5 - 17.5 mm; stretchable 5 - 5.2 mm; plain; snap-on type; violet

[www.wago.com/793-5501/000-024](http://www.wago.com/793-5501/000-024)



**Item no.:** 793-501/000-002

WMB marking card; as card; not stretchable; plain; snap-on type; yellow

[www.wago.com/793-501/000-002](http://www.wago.com/793-501/000-002)



**Item no.:** 793-501/000-007

WMB marking card; as card; not stretchable; plain; snap-on type; gray

[www.wago.com/793-501/000-007](http://www.wago.com/793-501/000-007)



**Item no.:** 793-501/000-017

WMB marking card; as card; not stretchable; plain; snap-on type; light green

[www.wago.com/793-501/000-017](http://www.wago.com/793-501/000-017)

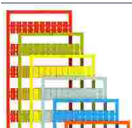

**Item no.:** 793-501/000-012

WMB marking card; as card; not stretchable; plain; snap-on type; orange

[www.wago.com/793-501/000-012](http://www.wago.com/793-501/000-012)

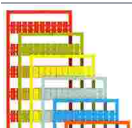

**Item no.:** 793-501/000-023

WMB marking card; as card; not stretchable; plain; snap-on type; green

[www.wago.com/793-501/000-023](http://www.wago.com/793-501/000-023)

Subject to changes. Please also observe the further product documentation!

WAGO GmbH & Co. KG

Hansastr. 27

32423 Minden

Phone: +49571 887-0 | Fax: +49571 887-169

Email: [info.de@wago.com](mailto:info.de@wago.com) | Web: [www.wago.com](http://www.wago.com)

Do you have any questions about our products?

We are always happy to take your call at +49 (571) 887-44222.



**Item no.: 793-501/000-006**  
WMB marking card; as card; not stretchable; plain; snap-on type; blue

[www.wago.com/793-501/000-006](http://www.wago.com/793-501/000-006)



**Item no.: 793-501/000-005**  
WMB marking card; as card; not stretchable; plain; snap-on type; red

[www.wago.com/793-501/000-005](http://www.wago.com/793-501/000-005)



**Item no.: 793-501**  
WMB marking card; as card; not stretchable; plain; snap-on type; white

[www.wago.com/793-501](http://www.wago.com/793-501)



**Item no.: 793-501/000-024**  
WMB marking card; as card; not stretchable; plain; snap-on type; violet

[www.wago.com/793-501/000-024](http://www.wago.com/793-501/000-024)



**Item no.: 793-5501/000-005**  
WMB marking card; as card; for terminal block width 5 - 17.5 mm; stretchable 5 - 5.2 mm; plain; snap-on type; red

[www.wago.com/793-5501/000-005](http://www.wago.com/793-5501/000-005)



**Item no.: 793-5501/000-002**  
WMB marking card; as card; for terminal block width 5 - 17.5 mm; stretchable 5 - 5.2 mm; plain; snap-on type; yellow

[www.wago.com/793-5501/000-002](http://www.wago.com/793-5501/000-002)



**Item no.: 793-5501/000-006**  
WMB marking card; as card; for terminal block width 5 - 17.5 mm; stretchable 5 - 5.2 mm; plain; snap-on type; blue

[www.wago.com/793-5501/000-006](http://www.wago.com/793-5501/000-006)



**Item no.: 793-5501**  
WMB marking card; as card; for terminal block width 5 - 17.5 mm; stretchable 5 - 5.2 mm; plain; snap-on type; white

[www.wago.com/793-5501](http://www.wago.com/793-5501)



**Item no.: 2009-115/000-012**  
WMB-Inline; for Smart Printer; 1500 pieces on roll; stretchable 5 - 5.2 mm; plain; snap-on type; orange

[www.wago.com/2009-115/000-012](http://www.wago.com/2009-115/000-012)



**Item no.: 2009-115/000-006**  
WMB-Inline; for Smart Printer; 1500 pieces on roll; stretchable 5 - 5.2 mm; plain; snap-on type; blue

[www.wago.com/2009-115/000-006](http://www.wago.com/2009-115/000-006)



**Item no.: 2009-115/000-005**  
WMB-Inline; for Smart Printer; 1500 pieces on roll; stretchable 5 - 5.2 mm; plain; snap-on type; red

[www.wago.com/2009-115/000-005](http://www.wago.com/2009-115/000-005)

Group marker carrier

Subject to changes. Please also observe the further product documentation!



**Item no.: 249-105**  
Group marker carrier; gray

**Cover**

Cover



**Item no.: 285-169**  
Finger guard; touchproof cover protects unused conductor entries and jumper slots; for 95 mm<sup>2</sup> high-current tbs; yellow [www.wago.com/285-169](http://www.wago.com/285-169)

**Ferrule**

Ferrule



**Item no.: 216-413**  
Ferrule; Sleeve for 25 mm<sup>2</sup> / AWG 4; uninsulated; electro-tin plated; electrolytic copper; gastight crimped; acc. to DIN 46228, Part 1/08.92; silver-colored [www.wago.com/216-413](http://www.wago.com/216-413)



**Item no.: 216-414**  
Ferrule; Sleeve for 35 mm<sup>2</sup> / AWG 2; uninsulated; electro-tin plated; electrolytic copper; gastight crimped; acc. to DIN 46228, Part 1/08.92; silver-colored [www.wago.com/216-414](http://www.wago.com/216-414)



**Item no.: 216-425**  
Ferrule; Sleeve for 50 mm<sup>2</sup> / AWG 1; uninsulated; electro-tin plated; electrolytic copper; gastight crimped; acc. to DIN 46228, Part 1/08.92 [www.wago.com/216-425](http://www.wago.com/216-425)



**Item no.: 216-424**  
Ferrule; Sleeve for 35 mm<sup>2</sup> / AWG 2; uninsulated; electro-tin plated; electrolytic copper; gastight crimped; acc. to DIN 46228, Part 1/08.92; silver-colored [www.wago.com/216-424](http://www.wago.com/216-424)



**Item no.: 216-435**  
Ferrule; Sleeve for 50 mm<sup>2</sup> / AWG 1; uninsulated; electro-tin plated; electrolytic copper; gastight crimped; acc. to DIN 46228, Part 1/08.92 [www.wago.com/216-435](http://www.wago.com/216-435)

**Voltage tap**

Power tap



**Item no.: 285-407**  
Power tap; for 95 mm<sup>2</sup> high-current tbs; 10,00 mm<sup>2</sup>; gray [www.wago.com/285-407](http://www.wago.com/285-407)

**Current and Voltage Taps**

Current and voltage tap



**Item no.: 855-951/250-000**  
Current and voltage tap up to 95 mm<sup>2</sup>; Primary rated current: 250 A; Secondary rated current: 1 A; Rated power: 0.2 VA; Accuracy class: 0.5; fused [www.wago.com/855-951/250-000](http://www.wago.com/855-951/250-000)

**Mounting**

Mounting accessories



**Item no.: 285-168**  
Fixing element; for 95 mm<sup>2</sup> high-current terminal blocks; orange [www.wago.com/285-168](http://www.wago.com/285-168)

**Protective warning marker**

Cover

Subject to changes. Please also observe the further product documentation!





**Item no.: 285-170**  
Protective warning marker; with high-voltage symbol, black; yellow

[www.wago.com/285-170](http://www.wago.com/285-170)



**Item no.: 285-175**  
Protective warning marker; yellow

[www.wago.com/285-175](http://www.wago.com/285-175)

### Tool

Operating tool



**Item no.: 285-172**  
Allen wrench; with a partially insulated shaft; green

[www.wago.com/285-172](http://www.wago.com/285-172)



**Item no.: 285-173**  
Allen wrench; with a partially insulated shaft; with anti-rotation protection; green

[www.wago.com/285-173](http://www.wago.com/285-173)

### Jumpers

Jumper



**Item no.: 285-495**  
Jumper; insulated; gray

[www.wago.com/285-495](http://www.wago.com/285-495)

## Downloads

### Documentation

#### Bid Text

285-184 X81 - Datei	2019 Feb 19	xml 3.3 kB	Download
285-184 doc - Datei	2018 Jan 4	doc 24.1 kB	Download

#### Additional Information

Technical Section Technical explanations		pdf 2.2 MB	Download
---	--	---------------	----------

## CAD/CAE-Data

### CAD data

2D/3D Models 285-184		URL	Download
----------------------	--	-----	----------

Subject to changes. Please also observe the further product documentation!

WAGO GmbH & Co. KG  
Hansastr. 27  
32423 Minden  
Phone: +49571 887-0 | Fax: +49571 887-169  
Email: [info.de@wago.com](mailto:info.de@wago.com) | Web: [www.wago.com](http://www.wago.com)

Do you have any questions about our products?  
We are always happy to take your call at +49 (571) 887-44222.

### CAE data

	URL	Download
EPLAN Data Portal 285-184	<a href="#">URL</a>	<a href="#">Download</a>
ZUKEN Portal 285-184	<a href="#">URL</a>	<a href="#">Download</a>

## Environmental Product Compliance

### Compliance Search

	URL	Download
Environmental Product Compliance 285-184 2-conductor through terminal block; 95 mm <sup>2</sup> ; lateral marker slots; with fixing flanges; POWER CAGE CLAMP; 95,00 mm <sup>2</sup> ; blue	<a href="#">URL</a>	<a href="#">Download</a>

## Installation Notes

### Installation

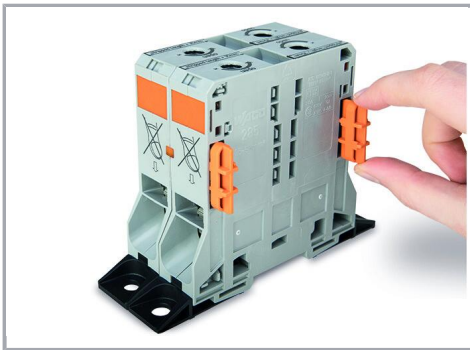

Optionally, insert block-to-block connector (285-168) into housing slot.

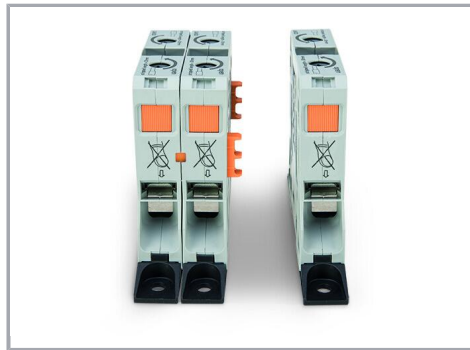

Align and snap high-current, through terminal blocks together.

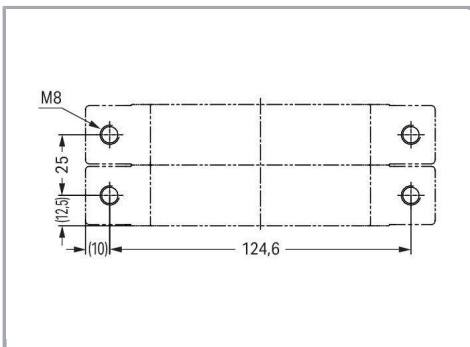

Subject to changes. Please also observe the further product documentation!