

# Power Metal Strip® Resistors, High Temperature (275 °C), Low Value (Down to 0.0001 Ω), Surface-Mount

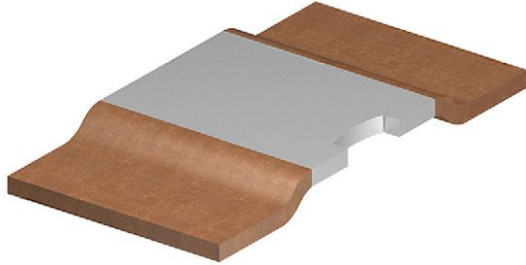

## LINKS TO ADDITIONAL RESOURCES



## FEATURES

- Ideal for all types of current sensing, voltage division and pulse applications including switching and linear power supplies, instruments, power amplifiers
- Proprietary processing technique produces extremely low resistance values, down to 0.0001 Ω
- Specially selected and stabilized materials allow for high temperature derating (to +275 °C)
- Sulfur resistance by construction that is unaffected by high sulfur environments
- All welded construction
- Solid metal iron-chrome or manganese-copper alloy resistive element with low TCR (< 20 ppm/°C)
- Very low inductance (< 5 nH)
- Low thermal EMF (< 3 μV/°C)
- AEC-Q200 qualified available <sup>(1)</sup>
- Material categorization: for definitions of compliance please see [www.vishay.com/doc?99912](http://www.vishay.com/doc?99912)

 AUTOMOTIVE  
GRADE  
Available

**RoHS**  
COMPLIANT  
**HALOGEN**  
**FREE**  
**GREEN**  
(5-2008)

### Note

<sup>(1)</sup> Flame retardance test may not be applicable to some resistor technologies

STANDARD ELECTRICAL SPECIFICATIONS						
GLOBAL MODEL	SIZE	POWER RATING $P_{70\text{ °C}}$ W	TOLERANCE %	RESISTANCE VALUE RANGE Ω	RESISTANCE VALUES CURRENTLY AVAILABLE <sup>(1)</sup> Ω	WEIGHT (typical) g/1000 pieces
WSLT3921	3921	3.0	1.0, 5.0	0.2m to 4m	0.2m, 0.3m, 0.5m, 0.7m, 1m, 1.5m, 2m, 2.5m, 3m, 4m	281
WSLT5931	5931	5.0	1.0, 5.0	0.3m to 3m	0.3m, 0.5m, 1m, 2m, 3m	398

### Note

<sup>(1)</sup> Other values may be available, contact factory

GLOBAL PART NUMBER INFORMATION																	
Global Part Numbering: <b>WSLT39212L000FEA</b> (WSLT3921, 0.002 Ω, ± 1 %)																	
(visit <a href="http://www.vishay.net">www.vishay.net</a> Vishay Dale parts numbering manual for all options)																	
W	S	L	T	3	9	2	1	2	L	0	0	0	F	E	A		
GLOBAL MODEL (7 digits)			RESISTANCE VALUE <sup>(1)</sup> (5 digits)			TOLERANCE CODE (1 digit)		PACKAGING CODE <sup>(2)</sup> (2 digits)				SPECIAL <sup>(3)</sup> (up to 2 digits)					
WSLT3921 WSLT5931			L = mΩ 2L000 = 0.002 Ω			F = ± 1.0 % J = ± 5.0 %		EA = lead (Pb)-free, tape/reel				Reserved for future specials					

### Notes

- <sup>(1)</sup> WSL marking ([www.vishay.com/doc?30327](http://www.vishay.com/doc?30327))
- <sup>(2)</sup> Packaging code: EB (lead (Pb)-free) and TB (tin / lead) are non-standard packaging codes designating 1000 piece reels. These non-standard packaging codes are identical to our standard EA (lead (Pb)-free) and TA (tin / lead), except that they have a package quantity of 1000 pieces
- <sup>(3)</sup> Follow link for customization capabilities: [www.vishay.com/doc?48163](http://www.vishay.com/doc?48163)

TECHNICAL SPECIFICATIONS			
PARAMETER	UNIT	RESISTOR CHARACTERISTICS	
		WSLT3921	WSLT5931
Component temperature coefficient (including terminal) <sup>(1)</sup> TCR measured from -55 °C to 150 °C	ppm/°C	+150 for 0.2 mΩ	+300 for 0.1 mΩ (+25 °C to +170 °C)
		+170 for 0.3 mΩ	± 225 for 0.2 mΩ
		+150 for 0.5 mΩ to 1 mΩ	± 175 for 0.3 mΩ and 0.5 mΩ
		+50 for 1.5 mΩ to 4 mΩ	± 75 for 1 mΩ to 4 mΩ
Element TCR <sup>(2)</sup>	ppm/°C	< 20	
Operating temperature range	°C	-65 to +275	
Maximum working voltage <sup>(3)</sup>	V	$(P \times R)^{1/2}$	

**Notes**

- (1) Component TCR - total TCR that includes the TCR effects of the resistor element and the copper terminal
- (2) Element TCR - only applies to the alloy used for the resistor element; refer to item 1 in the construction illustration on the following page
- (3) Maximum working voltage - the WSL is not voltage sensitive, but is limited by power / energy dissipation and is also not ESD sensitive

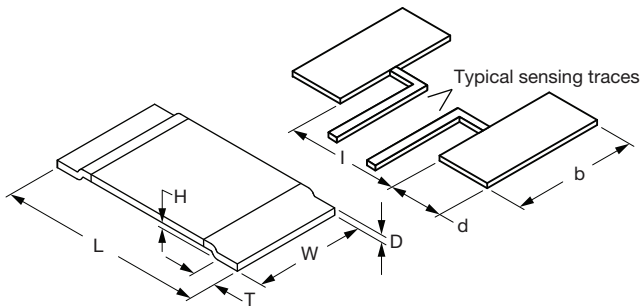
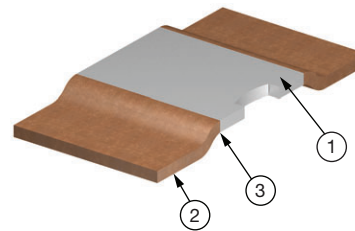
**DIMENSIONS** in inches (millimeters)

**CONSTRUCTION OUTLINE**

- ① Resistive element: Fe-Cr (element material used is dependent on resistance value)
- ② Terminal: solid copper
- ③ Terminal / element weld

**Notes**

- 3D models available: 3921 model [www.vishay.com/doc?30315](http://www.vishay.com/doc?30315); 5931 model [www.vishay.com/doc?30317](http://www.vishay.com/doc?30317)
- Surface-mount solder profile recommendations: [www.vishay.com/doc?31052](http://www.vishay.com/doc?31052)

MODEL	DIMENSIONS in inches (millimeters)				SOLDER PAD DIMENSIONS in inches (millimeters)		
	L	W	H <sup>(1)</sup>	T	d	b	l
WSLT3921	0.394 ± 0.010 (10.0 ± 0.254)	0.205 ± 0.015 (5.20 ± 0.381)	0.020 (0.5)	0.080 ± 0.010 (2.00 ± 0.254)	0.106 ± 0.010 (2.70 ± 0.254)	0.244 ± 0.010 (6.20 ± 0.254)	0.220 ± 0.005 (5.60 ± 0.13)
WSLT5931	0.591 ± 0.010 (15.0 ± 0.254)	0.305 ± 0.015 (7.75 ± 0.381)	0.020 (0.5)	0.157 ± 0.010 (4.00 ± 0.254)	0.205 ± 0.010 (5.20 ± 0.254)	0.344 ± 0.010 (8.75 ± 0.254)	0.220 ± 0.005 (5.60 ± 0.13)

**Note**

- (1) H dimension is reference only. Total height is H dimension + D thickness ± 0.010" (± 0.254 mm)

GLOBAL MODEL	RESISTANCE VALUE (mΩ)	TYPICAL THERMAL RESISTANCE (°C/W)	"D" THICKNESS (Inches)	ELEMENT MATERIAL
WSLT3921	0.2	2.7	0.0560	Mn-Cu
WSLT3921	0.5	5.8	0.0300	Mn-Cu
WSLT3921	0.7	6.3	0.0205	Mn-Cu
WSLT3921	1.0	10.9	0.0150	Mn-Cu
WSLT3921	2.0	12.0	0.0270	Fe-Cr
WSLT3921	3.0	20.7	0.0170	Fe-Cr
WSLT3921	4.0	22.8	0.0130	Fe-Cr
WSLT5931	0.1	1.6	0.0560	Mn-Cu-Sn
WSLT5931	0.3	3.5	0.0300	Mn-Cu
WSLT5931	0.5	5.7	0.0180	Mn-Cu
WSLT5931	1.0	7.2	0.0330	Fe-Cr
WSLT5931	2.0	13.2	0.0155	Fe-Cr
WSLT5931	3.0	19.3	0.0105	Fe-Cr

**Note**

- (1) The full power rating of power metal strip resistors are dependent upon the ability of the circuit board to dissipate the heat energy created in the resistance element. It is recommended to follow common design practices for power semiconductors that ensure the junction temperature is maintained within thermal limits by using large pad surfaces, thermal vias, heavier copper weights, internal layers as well as other thermal spreading features. The thermal resistance values provided function in the same manner as junction to terminal temperature



**DERATING - AMBIENT TEMPERATURE**

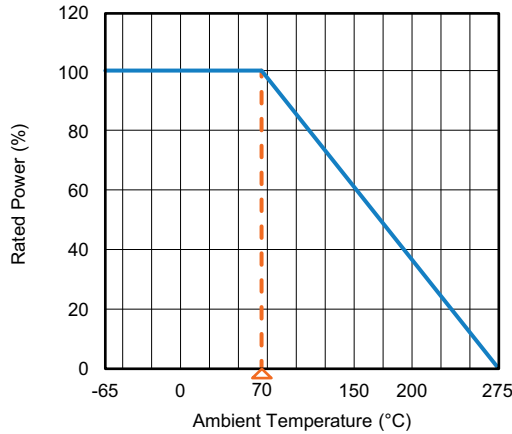

**PULSE CAPABILITY**

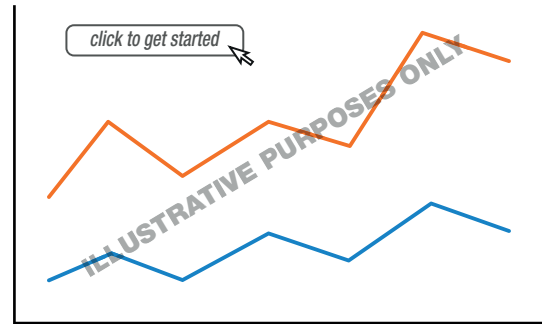

[www.vishay.com/resistors/power-metal-strip-calculator](http://www.vishay.com/resistors/power-metal-strip-calculator)

**DERATING - TERMINAL TEMPERATURE**

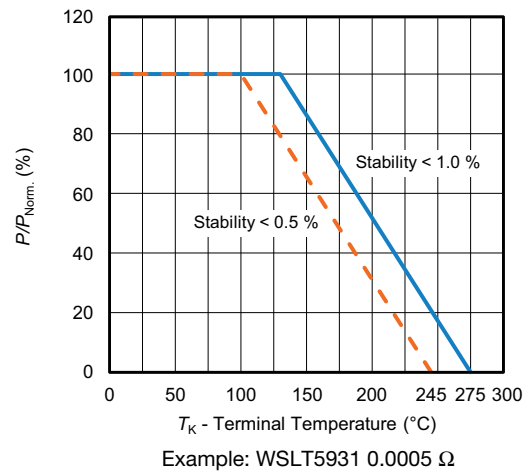
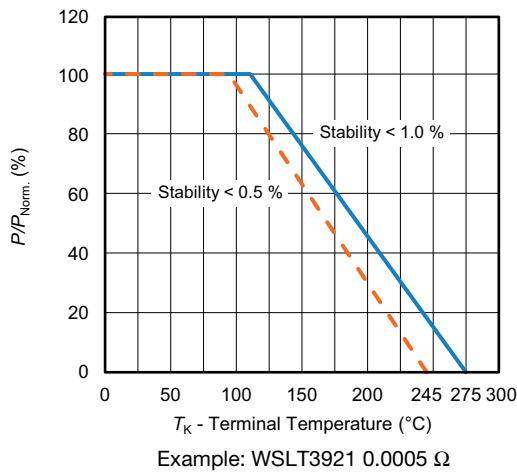

PERFORMANCE		
TEST	CONDITIONS OF TEST	TEST LIMITS
Thermal shock	-55 °C to +150 °C, 1000 cycles, 15 min at each extreme	± 1.0 % + 0.0005 Ω
Short time overload	Refer to link for short time overload performance and pulse capability; <a href="http://www.vishay.com/resistors/power-metal-strip-calculator/">www.vishay.com/resistors/power-metal-strip-calculator/</a>	± 0.5 %
Low temperature storage	-65 °C for 24 h	± 0.5 % + 0.0005 Ω
High temperature exposure	1000 h at +275 °C	± 1.0 % + 0.0005 Ω
Bias humidity	+85 °C, 85 % RH, 10 % bias, 1000 h	± 0.5 % + 0.0005 Ω
Mechanical shock	100 g's for 6 ms, 5 pulses	± 0.5 % + 0.0005 Ω
Vibration	Frequency varied 10 Hz to 2000 Hz in 1 min, 3 directions, 12 h	± 0.5 % + 0.0005 Ω
Load life	1000 h at +70 °C, 1.5 h "ON", 0.5 h "OFF"	± 1.0 % + 0.0005 Ω
Resistance to solder heat	3x at 250 °C ± 5 °C for 30 s ± 5 s	± 0.5 % + 0.0005 Ω
Moisture resistance	MIL-STD-202, method 106, 0 % power, 7a and 7b not required	± 0.5 % + 0.0005 Ω

PACKAGING				
MODEL	REEL			
	TAPE WIDTH	DIAMETER	PIECES/REEL	CODE
WSLT3921	16 mm / embossed plastic	330 mm / 13"	3000	EA
WSLT5931	24 mm / embossed plastic	330 mm / 13"	1500	EA

**Note**

- Embossed carrier tape per EIA-481



## Disclaimer

ALL PRODUCT, PRODUCT SPECIFICATIONS AND DATA ARE SUBJECT TO CHANGE WITHOUT NOTICE TO IMPROVE RELIABILITY, FUNCTION OR DESIGN OR OTHERWISE.

Vishay Intertechnology, Inc., its affiliates, agents, and employees, and all persons acting on its or their behalf (collectively, "Vishay"), disclaim any and all liability for any errors, inaccuracies or incompleteness contained in any datasheet or in any other disclosure relating to any product.

Vishay makes no warranty, representation or guarantee regarding the suitability of the products for any particular purpose or the continuing production of any product. To the maximum extent permitted by applicable law, Vishay disclaims (i) any and all liability arising out of the application or use of any product, (ii) any and all liability, including without limitation special, consequential or incidental damages, and (iii) any and all implied warranties, including warranties of fitness for particular purpose, non-infringement and merchantability.

Statements regarding the suitability of products for certain types of applications are based on Vishay's knowledge of typical requirements that are often placed on Vishay products in generic applications. Such statements are not binding statements about the suitability of products for a particular application. It is the customer's responsibility to validate that a particular product with the properties described in the product specification is suitable for use in a particular application. Parameters provided in datasheets and / or specifications may vary in different applications and performance may vary over time. All operating parameters, including typical parameters, must be validated for each customer application by the customer's technical experts. Product specifications do not expand or otherwise modify Vishay's terms and conditions of purchase, including but not limited to the warranty expressed therein.

Hyperlinks included in this datasheet may direct users to third-party websites. These links are provided as a convenience and for informational purposes only. Inclusion of these hyperlinks does not constitute an endorsement or an approval by Vishay of any of the products, services or opinions of the corporation, organization or individual associated with the third-party website. Vishay disclaims any and all liability and bears no responsibility for the accuracy, legality or content of the third-party website or for that of subsequent links.

Except as expressly indicated in writing, Vishay products are not designed for use in medical, life-saving, or life-sustaining applications or for any other application in which the failure of the Vishay product could result in personal injury or death. Customers using or selling Vishay products not expressly indicated for use in such applications do so at their own risk. Please contact authorized Vishay personnel to obtain written terms and conditions regarding products designed for such applications.

No license, express or implied, by estoppel or otherwise, to any intellectual property rights is granted by this document or by any conduct of Vishay. Product names and markings noted herein may be trademarks of their respective owners.