

PLEASE CHECK WWW.MOLEX.COM FOR LATEST PART INFORMATION

Part Number: [0466220600](#)
Status: **Active**
Overview: [Micro-Fit Connector System](#)
Description: Micro-Fit BMI Header, Surface Mount, Single Row, Right-Angle, with Solder Tab, Tin (Sn) Plating, 6 Circuits, Tape and Reel

Documents:

3D Model	Packaging Specification PK-46622-001-001 (PDF)
3D Model (PDF)	Symbol Footprint Data SYM-46622-0600-001 (PDF)
Drawing (PDF)	RoHS Certificate of Compliance (PDF)
Product Specification PS-44300-001-001 (PDF)	Product Literature (PDF)

Agency Certification

CSA LR19980

General

Product Family	PCB Headers
Series	46622
Application	Power, Wire-to-Board
Overview	Micro-Fit Connector System
Product Name	Micro-Fit BMI
UPC	191128235624

Physical

Breakaway	No
Circuits (Loaded)	6
Circuits (maximum)	6
Color - Resin	Black
Durability (mating cycles max)	30
First Mate / Last Break	No
Flammability	94V-0
Glow-Wire Capable	No
Guide to Mating Part	No
Keying to Mating Part	None
Lock to Mating Part	Yes
Material - Metal	Brass
Material - Plating Mating	Tin
Material - Plating Termination	Tin
Material - Resin	Liquid Crystal Polymer
Net Weight	1.625/g
Number of Rows	1
Orientation	Right Angle
PCB Locator	Yes
PCB Retention	Yes
Packaging Type	Embossed Tape on Reel
Pitch - Mating Interface	3.00mm
Plating min - Mating	1.524µm
Plating min - Termination	1.524µm
Polarized to Mating Part	Yes
Polarized to PCB	Yes
Shrouded	Fully
Stackable	No
Temperature Range - Operating	-40° to +105°C
Termination Interface: Style	Surface Mount

Electrical

Current - Maximum per Contact 8.5A

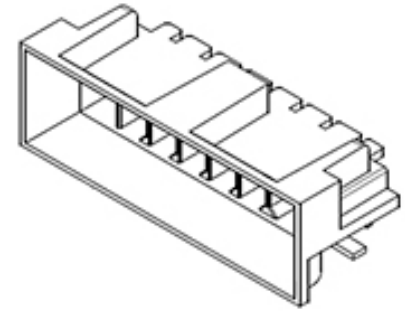

Series image - Reference only

EU ELV

Not Relevant

EU RoHS

Compliant

REACH SVHC

Not Contained Per -
D(2021)4569-DC (8
July 2021)

Halogen-Free

Status

Low-Halogen

For more information, please visit [Contact US](#)

China ROHS

ELV

RoHS Phthalates

China RoHS

Green Image

Not Relevant

Not Contained

Search Parts in this Series

[46622](#) Series

Mates With

[46623](#) Micro-Fit BMI Panel Mount
Receptacle Housing

Voltage - Maximum 600V

Solder Process Data

Duration at Max. Process Temperature (seconds) 030

Lead-free Process Capability REFLOW

Max. Cycles at Max. Process Temperature 003

Process Temperature max. C 260

Material Info

Reference - Drawing Numbers

Packaging Specification PK-46622-001-001

Product Specification PS-44300-001-001

Sales Drawing SD-46622-0000-001

Symbol/Footprint Data SYM-46622-0600-001

This document was generated on 11/10/2021

PLEASE CHECK WWW.MOLEX.COM FOR LATEST PART INFORMATION