

**Data sheet | Item number: 2102-1301**

3-conductor through terminal block; with lever and Push-in CAGE CLAMP®; 2.5 mm<sup>2</sup>; with test port; side and center marking; for DIN-rail 35 x 15 and 35 x 7.5; Push-in CAGE CLAMP®; 2,50 mm<sup>2</sup>; gray

[www.wago.com/2102-1301](http://www.wago.com/2102-1301)

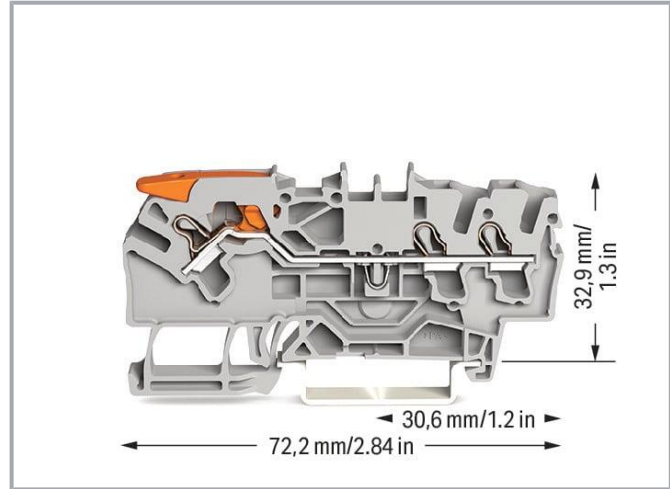
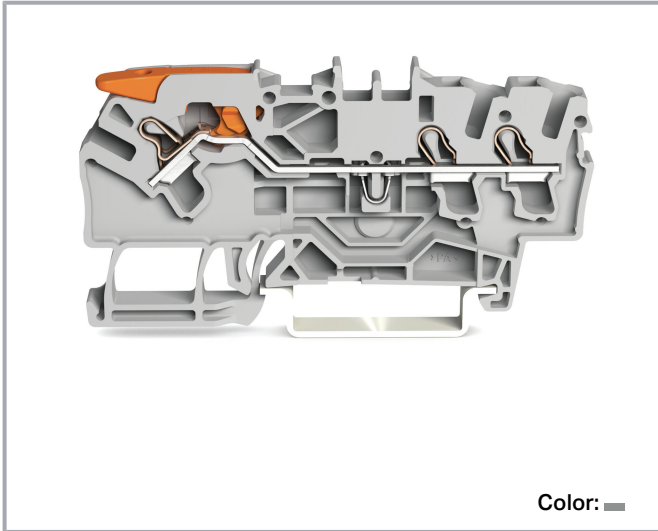

Color: ■

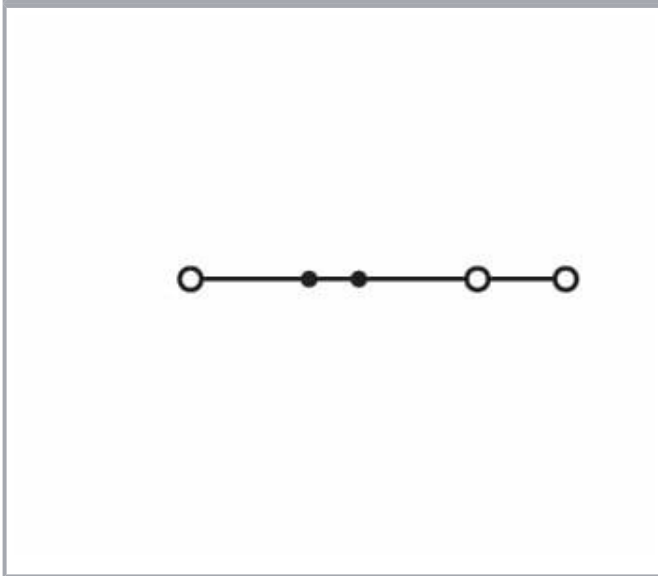

**Data**

**Electrical data**

**Ratings per IEC/EN**

Ratings per

IEC/EN 60947-7-1

Subject to changes. Please also observe the further product documentation!

WAGO GmbH & Co. KG  
Hansastr. 27  
32423 Minden  
Phone: +49571 887-0 | Fax: +49571 887-169  
Email: [info.de@wago.com](mailto:info.de@wago.com) | Web: [www.wago.com](http://www.wago.com)

Do you have any questions about our products?  
We are always happy to take your call at +49 (571) 887-44222.



Nominal voltage (III/3)	800 V
Rated impulse voltage (III/3)	8 kV
Rated current	24 A
Current at conductor cross-section (max.) mm <sup>2</sup>	30 A
Legend (ratings)	(III / 3) ≙ Overvoltage category III / Pollution degree 3

### Ratings per UL 1059

Approvals per	UL 1059
Rated voltage UL (Use Group B)	600 V
Rated current UL (Use Group B)	20 A
Rated voltage UL (Use Group C)	600 V
Rated current UL (Use Group C)	20 A

### Ratings per CSA

Approvals per	CSA 22.2 No 158
Rated voltage CSA (Use Group B)	600 V
Rated current CSA (Use Group B)	20 A
Rated voltage CSA (Use Group C)	600 V
Rated current CSA (Use Group C)	20 A

### Ex information

Reference hazardous areas	See "Downloads – Documentation – Additional Information: Technical Section; Technical Explications"
Ratings per	ATEX: PTB 18 ATEX 1010 U / IECEx: PTB 18.0001U (Ex eb IIC Gb)
Rated voltage EN (Ex e II)	550 V
Rated current (Ex e II)	23.5 A
Rated current (Ex e II) with jumper	20 A

### Power loss

Power loss, per pole (potential)	0.766 W
Rated current $I_N$ for specified power loss	24 A
Resistance value for specified, current-dependent power loss	0.001 Ω

### Connection data

Connection points	3
Total number of potentials	1

Subject to changes. Please also observe the further product documentation!



Number of levels	1
Number of jumper slots	2

### Connection 1

Connection technology	Push-in CAGE CLAMP®
Actuation type	Lever
Connectable conductor materials	Copper
Nominal cross-section	2.5 mm <sup>2</sup>
Solid conductor	0.25 ... 4 mm <sup>2</sup> / 22 ... 12 AWG
Solid conductor; push-in termination	0.75 ... 4 mm <sup>2</sup> / 18 ... 12 AWG
Fine-stranded conductor	0.25 ... 4 mm <sup>2</sup> / 22 ... 12 AWG
Fine-stranded conductor; with insulated ferrule	0.25 ... 2.5 mm <sup>2</sup> / 22 ... 14 AWG
Fine-stranded conductor; with ferrule; push-in termination	1 ... 2.5 mm <sup>2</sup> / 18 ... 14 AWG
Note (conductor cross-section)	Depending on the conductor characteristic, a conductor with a smaller cross-section can also be inserted via push-in termination.
Strip length	10 ... 12 mm / 0.39 ... 0.47 inches
Wiring direction	Front-entry wiring

### Connection 2

Actuation type 2	Operating tool
------------------	----------------

### Physical data

Width	5.2 mm / 0.205 inches
Height	72.2 mm / 2.843 inches
Depth from upper-edge of DIN-rail	32.9 mm / 1.295 inches

### Mechanical Data

Mounting type	DIN-35 rail
Marking level	Center/side marking

### Material Data

Note (material data)	Information on material specifications can be found here
Color	gray
Material group	I

Subject to changes. Please also observe the further product documentation!

Insulation material	Polyamide (PA66)
Flammability class per UL94	V0
Fire load	0.173 MJ
Weight	8 g

### Environmental requirements

Processing temperature	-35 ... +85 °C
Continuous operating temperature	-60 ... +105 °C

### Commercial data

eCl@ss 10.0	27-14-11-20
eCl@ss 9.0	27-14-11-20
ETIM 8.0	EC000897
ETIM 7.0	EC000897
PU (SPU)	50 pcs
Packaging type	box
Country of origin	DE
GTIN	4055143741798
Customs tariff number	85369010000

### Environmental Product Compliance

RoHS Compliance Status	Compliant, No Exemption
------------------------	-------------------------

### Approvals / Certificates

#### General approvals

Logo	Approval	Additional Approval Text	Certificate name
	CCA DEKRA Certification B.V.	EN 60947	NTR NL 7670
	CCC CNEX	GB/T 3836.3	2020312313000163 (Ex eb IIC Gb, Ex eb I Mb)
	CSA DEKRA Certification B.V.	C22.2	70175030

Subject to changes. Please also observe the further product documentation!

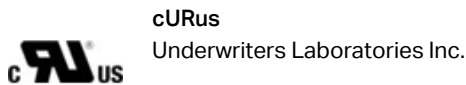

cURus  
Underwriters Laboratories Inc.

UL 1059

E45172





KEMA/KEUR  
DEKRA Certification B.V.





EN 60947

71-102882

## Declarations of conformity and manufacturer's declarations

Logo	Approval	Additional Approval Text	Certificate name
	EU-Declaration of Conformity WAGO GmbH & Co. KG	-	-
	UK-Declaration of Conformity WAGO GmbH & Co. KG	-	-

## Approvals for marine applications

Logo	Approval	Additional Approval Text	Certificate name
	ABS American Bureau of Shipping	-	19- HG1866350- PDA
	BV Bureau Veritas S.A.	IEC 60947	58186/A0 BV
	DNV GL Det Norske Veritas, Germanischer Lloyd	-	TAE00003JT
	LR Lloyds Register	-	19/20050

## Approvals for hazardous areas

Logo	Approval	Additional Approval Text	Certificate name
	AEx	UL 60079	20181105-E185892

Subject to changes. Please also observe the further product documentation!

WAGO GmbH & Co. KG  
Hansastr. 27  
32423 Minden  
Phone: +49571 887-0 | Fax: +49571 887-169  
Email: [info.de@wago.com](mailto:info.de@wago.com) | Web: [www.wago.com](http://www.wago.com)

Do you have any questions about our products?  
We are always happy to take your call at +49 (571) 887-44222.

Underwriters Laboratories Inc.





(AEx eb IIC resp. Ex eb IIC)

	<b>ATEX</b> Physikalisch Technische Bundesanstalt	EN 60079-0	PTB 18 ATEX 1010 U (II 2 G Ex eb IIC Gb bzw. I M 2 Ex eb I Mb)
	<b>CCC</b> CNEX	GB/T 3836.3	2020312313000163 (Ex eb IIC Gb, Ex eb I Mb)
	<b>EAC</b> Brjansker Zertifizierungsstelle	TP TC 012/2011	RU C-DE.AM02.B. 00127/19 (Ex e IIC Gb U)
	<b>IECEX</b> Physikalisch Technische Bundesanstalt	IEC 60079-0	IECEX PTB 18.0017U (Ex eb IIC Gb resp. Ex eb I Mb)
	<b>INMETRO</b> TÜV Rheinland do Brasil Ltda.	IEC 60079	TÜV 19.0818 U

## Required accessories

### End plate



End plate

	<b>Item no.: 2102-1391</b> End and intermediate plate; 0.8 mm thick; for 3-conductor terminal blocks; gray	<a href="http://www.wago.com/2102-1391">www.wago.com/2102-1391</a>
	<b>Item no.: 2102-1392</b> End and intermediate plate; 0.8 mm thick; for 3-conductor terminal blocks; orange	<a href="http://www.wago.com/2102-1392">www.wago.com/2102-1392</a>

## Optional accessories

### Marking accessories

Marking strip

	<b>Item no.: 2009-110</b> Marking strips; for Smart Printer; on reel; not stretchable; plain; snap-on type; white	<a href="http://www.wago.com/2009-110">www.wago.com/2009-110</a>
	<b>Item no.: 2009-198</b>	

Subject to changes. Please also observe the further product documentation!













Adaptor; gray

[www.wago.com/2009-198](http://www.wago.com/2009-198)
**Item no.: 2002-161**  
 Adaptor; gray
[www.wago.com/2002-161](http://www.wago.com/2002-161)

## Marker

**Item no.: 2009-115/000-002**  
 WMB-Inline; for Smart Printer; 1500 pieces on roll; stretchable 5 - 5.2 mm; plain; snap-on type; yellow
[www.wago.com/2009-115/000-002](http://www.wago.com/2009-115/000-002)
**Item no.: 2009-115/000-007**  
 WMB-Inline; for Smart Printer; 1500 pieces on roll; stretchable 5 - 5.2 mm; plain; snap-on type; gray
[www.wago.com/2009-115/000-007](http://www.wago.com/2009-115/000-007)
**Item no.: 2009-115/000-017**  
 WMB-Inline; for Smart Printer; 1500 pieces on roll; stretchable 5 - 5.2 mm; plain; snap-on type; light green
[www.wago.com/2009-115/000-017](http://www.wago.com/2009-115/000-017)
**Item no.: 2009-115/000-023**  
 WMB-Inline; for Smart Printer; 1500 pieces on roll; stretchable 5 - 5.2 mm; plain; snap-on type; green
[www.wago.com/2009-115/000-023](http://www.wago.com/2009-115/000-023)
**Item no.: 2009-115/000-024**  
 WMB-Inline; for Smart Printer; 1500 pieces on roll; stretchable 5 - 5.2 mm; plain; snap-on type; violet
[www.wago.com/2009-115/000-024](http://www.wago.com/2009-115/000-024)
**Item no.: 2009-145/000-006**  
 Mini-WSB Inline; for Smart Printer; 1700 pieces on roll; stretchable 5 - 5.2 mm; plain; snap-on type; blue
[www.wago.com/2009-145/000-006](http://www.wago.com/2009-145/000-006)
**Item no.: 2009-145**  
 Mini-WSB Inline; for Smart Printer; 1700 pieces on roll; stretchable 5 - 5.2 mm; plain; snap-on type; white
[www.wago.com/2009-145](http://www.wago.com/2009-145)
**Item no.: 2009-145/000-002**  
 Mini-WSB Inline; for Smart Printer; 1700 pieces on roll; stretchable 5 - 5.2 mm; plain; snap-on type; yellow
[www.wago.com/2009-145/000-002](http://www.wago.com/2009-145/000-002)
**Item no.: 2009-145/000-007**  
 Mini-WSB Inline; for Smart Printer; 1700 pieces on roll; stretchable 5 - 5.2 mm; plain; snap-on type; gray
[www.wago.com/2009-145/000-007](http://www.wago.com/2009-145/000-007)
**Item no.: 2009-145/000-005**  
 Mini-WSB Inline; for Smart Printer; 1700 pieces on roll; stretchable 5 - 5.2 mm; plain; snap-on type; red
[www.wago.com/2009-145/000-005](http://www.wago.com/2009-145/000-005)
**Item no.: 2009-145/000-012**  
 Mini-WSB Inline; for Smart Printer; 1700 pieces on roll; stretchable 5 - 5.2 mm; plain; snap-on type; orange
[www.wago.com/2009-145/000-012](http://www.wago.com/2009-145/000-012)**Item no.: 2009-145/000-023**

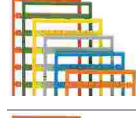
Subject to changes. Please also observe the further product documentation!

	Mini-WSB Inline; for Smart Printer; 1700 pieces on roll; stretchable 5 - 5.2 mm; plain; snap-on type; green	<a href="http://www.wago.com/2009-145/000-023">www.wago.com/2009-145/000-023</a>
	<b>Item no.: 2009-145/000-024</b> Mini-WSB Inline; for Smart Printer; 1700 pieces on roll; stretchable 5 - 5.2 mm; plain; snap-on type; violet	<a href="http://www.wago.com/2009-145/000-024">www.wago.com/2009-145/000-024</a>
	<b>Item no.: 2009-115</b> WMB-Inline; for Smart Printer; 1500 pieces on roll; stretchable 5 - 5.2 mm; plain; snap-on type; white	<a href="http://www.wago.com/2009-115">www.wago.com/2009-115</a>
	<b>Item no.: 248-501/000-006</b> Mini-WSB marking card; as card; not stretchable; plain; snap-on type; blue	<a href="http://www.wago.com/248-501/000-006">www.wago.com/248-501/000-006</a>
	<b>Item no.: 248-501/000-007</b> Mini-WSB marking card; as card; not stretchable; plain; snap-on type; gray	<a href="http://www.wago.com/248-501/000-007">www.wago.com/248-501/000-007</a>
	<b>Item no.: 248-501/000-002</b> Mini-WSB marking card; as card; not stretchable; plain; snap-on type; yellow	<a href="http://www.wago.com/248-501/000-002">www.wago.com/248-501/000-002</a>
	<b>Item no.: 248-501/000-012</b> Mini-WSB marking card; as card; not stretchable; plain; snap-on type; orange	<a href="http://www.wago.com/248-501/000-012">www.wago.com/248-501/000-012</a>
	<b>Item no.: 248-501</b> Mini-WSB marking card; as card; not stretchable; plain; snap-on type; white	<a href="http://www.wago.com/248-501">www.wago.com/248-501</a>
	<b>Item no.: 248-501/000-017</b> Mini-WSB marking card; as card; not stretchable; plain; snap-on type; light green	<a href="http://www.wago.com/248-501/000-017">www.wago.com/248-501/000-017</a>
	<b>Item no.: 248-501/000-005</b> Mini-WSB marking card; as card; not stretchable; plain; snap-on type; red	<a href="http://www.wago.com/248-501/000-005">www.wago.com/248-501/000-005</a>
	<b>Item no.: 248-501/000-024</b> Mini-WSB marking card; as card; not stretchable; plain; snap-on type; violet	<a href="http://www.wago.com/248-501/000-024">www.wago.com/248-501/000-024</a>
	<b>Item no.: 248-501/000-023</b> Mini-WSB marking card; as card; not stretchable; plain; snap-on type; green	<a href="http://www.wago.com/248-501/000-023">www.wago.com/248-501/000-023</a>

Subject to changes. Please also observe the further product documentation!





**Item no.:** 793-5501/000-007

WMB marking card; as card; for terminal block width 5 - 17.5 mm; stretchable 5 - 5.2 mm; plain; snap-on type; gray [www.wago.com/793-5501/000-007](http://www.wago.com/793-5501/000-007)



**Item no.:** 793-5501/000-012

WMB marking card; as card; for terminal block width 5 - 17.5 mm; stretchable 5 - 5.2 mm; plain; snap-on type; orange [www.wago.com/793-5501/000-012](http://www.wago.com/793-5501/000-012)



**Item no.:** 793-5501/000-017

WMB marking card; as card; for terminal block width 5 - 17.5 mm; stretchable 5 - 5.2 mm; plain; snap-on type; light green [www.wago.com/793-5501/000-017](http://www.wago.com/793-5501/000-017)



**Item no.:** 793-5501/000-023

WMB marking card; as card; for terminal block width 5 - 17.5 mm; stretchable 5 - 5.2 mm; plain; snap-on type; green [www.wago.com/793-5501/000-023](http://www.wago.com/793-5501/000-023)



**Item no.:** 793-5501/000-024

WMB marking card; as card; for terminal block width 5 - 17.5 mm; stretchable 5 - 5.2 mm; plain; snap-on type; violet [www.wago.com/793-5501/000-024](http://www.wago.com/793-5501/000-024)



**Item no.:** 793-5501/000-005

WMB marking card; as card; for terminal block width 5 - 17.5 mm; stretchable 5 - 5.2 mm; plain; snap-on type; red [www.wago.com/793-5501/000-005](http://www.wago.com/793-5501/000-005)



**Item no.:** 793-5501/000-002

WMB marking card; as card; for terminal block width 5 - 17.5 mm; stretchable 5 - 5.2 mm; plain; snap-on type; yellow [www.wago.com/793-5501/000-002](http://www.wago.com/793-5501/000-002)



**Item no.:** 793-5501/000-006

WMB marking card; as card; for terminal block width 5 - 17.5 mm; stretchable 5 - 5.2 mm; plain; snap-on type; blue [www.wago.com/793-5501/000-006](http://www.wago.com/793-5501/000-006)



**Item no.:** 793-5501

WMB marking card; as card; for terminal block width 5 - 17.5 mm; stretchable 5 - 5.2 mm; plain; snap-on type; white [www.wago.com/793-5501](http://www.wago.com/793-5501)



**Item no.:** 2009-115/000-012

WMB-Inline; for Smart Printer; 1500 pieces on roll; stretchable 5 - 5.2 mm; plain; snap-on type; orange [www.wago.com/2009-115/000-012](http://www.wago.com/2009-115/000-012)



**Item no.:** 2009-115/000-006

WMB-Inline; for Smart Printer; 1500 pieces on roll; stretchable 5 - 5.2 mm; plain; snap-on type; blue [www.wago.com/2009-115/000-006](http://www.wago.com/2009-115/000-006)

Group marker carrier



Subject to changes. Please also observe the further product documentation!

WAGO GmbH & Co. KG

Hansastr. 27

32423 Minden

Phone: +49571 887-0 | Fax: +49571 887-169

Email: [info.de@wago.com](mailto:info.de@wago.com) | Web: [www.wago.com](http://www.wago.com)

Do you have any questions about our products?

We are always happy to take your call at +49 (571) 887-44222.

	<b>Item no.: 2009-193</b> Group marker carrier; gray	<a href="http://www.wago.com/2009-193">www.wago.com/2009-193</a>
	<b>Item no.: 2009-192</b> Group marker carrier; gray	<a href="http://www.wago.com/2009-192">www.wago.com/2009-192</a>
	<b>Item no.: 2009-191</b> Group marker carrier; gray	<a href="http://www.wago.com/2009-191">www.wago.com/2009-191</a>
<b>Insulation stop</b>		
Insulation stop		
	<b>Item no.: 2002-171</b> Insulation stop; 0.25 - 0.5 mm <sup>2</sup> ; 5 pieces/strip; light gray	<a href="http://www.wago.com/2002-171">www.wago.com/2002-171</a>
	<b>Item no.: 2002-172</b> Insulation stop; 0.75 - 1 mm <sup>2</sup> ; 5 pieces/strip; dark gray	<a href="http://www.wago.com/2002-172">www.wago.com/2002-172</a>
<b>Push-in type wire jumper</b>		
Jumper		
	<b>Item no.: 2009-412</b> Push-in type wire jumper; insulated; 60 mm long; black	<a href="http://www.wago.com/2009-412">www.wago.com/2009-412</a>
	<b>Item no.: 2009-414</b> Push-in type wire jumper; 1.5 mm <sup>2</sup> ; insulated; 110 mm long; black	<a href="http://www.wago.com/2009-414">www.wago.com/2009-414</a>
	<b>Item no.: 2009-416</b> Push-in type wire jumper; 1.5 mm <sup>2</sup> ; insulated; 250 mm long; black	<a href="http://www.wago.com/2009-416">www.wago.com/2009-416</a>
	<b>Item no.: 2009-414/000-005</b> Push-in type wire jumper; 1.5 mm <sup>2</sup> ; insulated; 110 mm long; black	<a href="http://www.wago.com/2009-414/000-005">www.wago.com/2009-414/000-005</a>
	<b>Item no.: 2009-414/000-006</b> Push-in type wire jumper; insulated; 110 mm long; black	<a href="http://www.wago.com/2009-414/000-006">www.wago.com/2009-414/000-006</a>
<b>Carrier rail</b>		
Mounting accessories		
	<b>Item no.: 210-197</b> Steel carrier rail; 35 x 15 mm; 1.5 mm thick; 2 m long; slotted; similar to EN 60715; silver-colored	<a href="http://www.wago.com/210-197">www.wago.com/210-197</a>
	<b>Item no.: 210-198</b> Copper carrier rail; 35 x 15 mm; 2.3 mm thick; 2 m long; unslotted; according to EN 60715; copper-colored	<a href="http://www.wago.com/210-198">www.wago.com/210-198</a>
	<b>Item no.: 210-113</b> Steel carrier rail; 35 x 7.5 mm; 1 mm thick; 2 m long; unslotted; according to EN 60715; silver-colored	<a href="http://www.wago.com/210-113">www.wago.com/210-113</a>

Subject to changes. Please also observe the further product documentation!

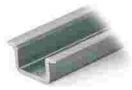

**Item no.: 210-118**

Steel carrier rail; 35 x 15 mm; 2.3 mm thick; 2 m long; unslotted; according to EN 60715; silver-colored

[www.wago.com/210-118](http://www.wago.com/210-118)



**Item no.: 210-112**

Steel carrier rail; 35 x 7.5 mm; 1 mm thick; 2 m long; slotted; according to EN 60715; "Hole width 25 mm; silver-colored

[www.wago.com/210-112](http://www.wago.com/210-112)



**Item no.: 210-114**

Steel carrier rail; 35 x 15 mm; 1.5 mm thick; 2 m long; unslotted; similar to EN 60715; silver-colored

[www.wago.com/210-114](http://www.wago.com/210-114)



**Item no.: 210-115**

Steel carrier rail; 35 x 7.5 mm; 1 mm thick; 2 m long; slotted; according to EN 60715; "Hole width 18 mm; silver-colored

[www.wago.com/210-115](http://www.wago.com/210-115)

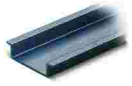

**Item no.: 210-196**

Aluminum carrier rail; 35 x 8.2 mm; 1.6 mm thick; 2 m long; unslotted; similar to EN 60715; silver-colored

[www.wago.com/210-196](http://www.wago.com/210-196)

## Plugs

### Diode plug



**Item no.: 2002-880/1000-411**

Component plug; 2-pole; with diode 1N4007; 10.4 mm wide; Operating temperature 85°C max.; gray

[www.wago.com/2002-880](http://www.wago.com/2002-880)

[/1000-411](http://www.wago.com/1000-411)

### LED plug



**Item no.: 2002-880/1000-541**

Component plug; 2-pole; LED (red); 10.4 mm wide; Operating temperature 85°C max.; gray

[www.wago.com/2002-880](http://www.wago.com/2002-880)

[/1000-541](http://www.wago.com/1000-541)



**Item no.: 2002-880/1000-542**

Component plug; 2-pole; LED (red); 10.4 mm wide; Operating temperature 85°C max.; multicoloured

[www.wago.com/2002-880](http://www.wago.com/2002-880)

[/1000-542](http://www.wago.com/1000-542)



**Item no.: 2002-880/1000-836**

Component plug; 2-pole; LED (red); 10.4 mm wide; Operating temperature 85°C max.; gray

[www.wago.com/2002-880](http://www.wago.com/2002-880)

[/1000-836](http://www.wago.com/1000-836)

### Empty component plug housing



**Item no.: 2002-880**

Empty component plug housing; 10.4 mm wide; 2-pole; Type 4; gray

[www.wago.com/2002-880](http://www.wago.com/2002-880)

## Tool

### Operating tool



**Item no.: 210-658**

Operating tool; Blade: 3.5 x 0.5 mm; with a partially insulated shaft; angled; short; multicoloured

[www.wago.com/210-658](http://www.wago.com/210-658)



**Item no.: 210-720**

Operating tool; Blade: 3.5 x 0.5 mm; with a partially insulated shaft; multicoloured

[www.wago.com/210-720](http://www.wago.com/210-720)

Subject to changes. Please also observe the further product documentation!

WAGO GmbH & Co. KG

Hansastr. 27

32423 Minden

Phone: +49571 887-0 | Fax: +49571 887-169

Email: [info.de@wago.com](mailto:info.de@wago.com) | Web: [www.wago.com](http://www.wago.com)

Do you have any questions about our products?

We are always happy to take your call at +49 (571) 887-44222.

## Protective warning marker

Cover

**Item no.: 2002-115**

Protective warning marker; for 5 terminal blocks; with high-voltage symbol, black; yellow

[www.wago.com/2002-115](http://www.wago.com/2002-115)

## Mounting

Cover carrier

**Item no.: 709-169**

Cover carrier; Type 3; gray

[www.wago.com/709-169](http://www.wago.com/709-169)

Cover

**Item no.: 709-156**

Cover; Type 3; suitable for cover carrier, type 3; 1 m long; transparent

[www.wago.com/709-156](http://www.wago.com/709-156)

## Jumpers

Jumper

**Item no.: 210-123**

Wire commoning chain; insulated; blue

[www.wago.com/210-123](http://www.wago.com/210-123)**Item no.: 2002-402**

Jumper; 2-way; insulated; light gray

[www.wago.com/2002-402](http://www.wago.com/2002-402)**Item no.: 2002-402/000-005**

Jumper; 2-way; insulated; red

[www.wago.com/2002-402/000-005](http://www.wago.com/2002-402/000-005)**Item no.: 2002-400**

Continuous jumper; 2-way; insulated; light gray

[www.wago.com/2002-400](http://www.wago.com/2002-400)**Item no.: 2002-403**

Jumper; 3-way; insulated; light gray

[www.wago.com/2002-403](http://www.wago.com/2002-403)**Item no.: 2002-404/000-005**

Jumper; 4-way; insulated; red

[www.wago.com/2002-404/000-005](http://www.wago.com/2002-404/000-005)**Item no.: 2002-403/000-006**

Jumper; 3-way; insulated; blue

[www.wago.com/2002-403/000-006](http://www.wago.com/2002-403/000-006)**Item no.: 2002-404/000-006**

Jumper; 4-way; insulated; blue

[www.wago.com/2002-404/000-006](http://www.wago.com/2002-404/000-006)**Item no.: 2002-403/000-005**

Jumper; 3-way; insulated; red

[www.wago.com/2002-403/000-005](http://www.wago.com/2002-403/000-005)

Subject to changes. Please also observe the further product documentation!

WAGO GmbH &amp; Co. KG

Hansastr. 27













32423 Minden

Phone: +49571 887-0 | Fax: +49571 887-169

Email: [info.de@wago.com](mailto:info.de@wago.com) | Web: [www.wago.com](http://www.wago.com)

Do you have any questions about our products?

We are always happy to take your call at +49 (571) 887-44222.

	<b>Item no.: 2002-405/000-005</b> Jumper; 5-way; insulated; red	<a href="http://www.wago.com/2002-405/000-005">www.wago.com/2002-405/000-005</a>
	<b>Item no.: 2002-402/000-006</b> Jumper; 2-way; insulated; blue	<a href="http://www.wago.com/2002-402/000-006">www.wago.com/2002-402/000-006</a>
	<b>Item no.: 2002-405/000-006</b> Jumper; 5-way; insulated; blue	<a href="http://www.wago.com/2002-405/000-006">www.wago.com/2002-405/000-006</a>
	<b>Item no.: 2002-404</b> Jumper; 4-way; insulated; light gray	<a href="http://www.wago.com/2002-404">www.wago.com/2002-404</a>
	<b>Item no.: 2002-406/000-006</b> Jumper; 6-way; insulated; blue	<a href="http://www.wago.com/2002-406/000-006">www.wago.com/2002-406/000-006</a>
	<b>Item no.: 2002-406/000-005</b> Jumper; 6-way; insulated; red	<a href="http://www.wago.com/2002-406/000-005">www.wago.com/2002-406/000-005</a>
	<b>Item no.: 2002-406/020-000</b> Delta jumper; insulated; light gray	<a href="http://www.wago.com/2002-406/020-000">www.wago.com/2002-406/020-000</a>
	<b>Item no.: 2002-405</b> Jumper; 5-way; insulated; light gray	<a href="http://www.wago.com/2002-405">www.wago.com/2002-405</a>
	<b>Item no.: 2002-407/000-005</b> Jumper; 7-way; insulated; red	<a href="http://www.wago.com/2002-407/000-005">www.wago.com/2002-407/000-005</a>
	<b>Item no.: 2002-408</b> Jumper; 8-way; insulated; light gray	<a href="http://www.wago.com/2002-408">www.wago.com/2002-408</a>
	<b>Item no.: 2002-408/000-006</b> Jumper; 8-way; insulated; blue	<a href="http://www.wago.com/2002-408/000-006">www.wago.com/2002-408/000-006</a>
	<b>Item no.: 2002-405/011-000</b> Star point jumper; 3-way; insulated; light gray	<a href="http://www.wago.com/2002-405/011-000">www.wago.com/2002-405/011-000</a>

Subject to changes. Please also observe the further product documentation!



**Item no.: 2002-407/000-006**  
Jumper; 7-way; insulated; blue

[www.wago.com/2002-407/000-006](http://www.wago.com/2002-407/000-006)



**Item no.: 2002-408/000-005**  
Jumper; 8-way; insulated; red

[www.wago.com/2002-408/000-005](http://www.wago.com/2002-408/000-005)



**Item no.: 2002-407**  
Jumper; 7-way; insulated; light gray

[www.wago.com/2002-407](http://www.wago.com/2002-407)



**Item no.: 2002-406**  
Jumper; 6-way; insulated; light gray

[www.wago.com/2002-406](http://www.wago.com/2002-406)



**Item no.: 2002-410/000-005**  
Jumper; 10-way; insulated; red

[www.wago.com/2002-410/000-005](http://www.wago.com/2002-410/000-005)



**Item no.: 2002-410/000-006**  
Jumper; 10-way; insulated; blue

[www.wago.com/2002-410/000-006](http://www.wago.com/2002-410/000-006)



**Item no.: 2002-410**  
Jumper; 10-way; insulated; light gray

[www.wago.com/2002-410](http://www.wago.com/2002-410)



**Item no.: 2002-409/000-006**  
Jumper; 9-way; insulated; blue

[www.wago.com/2002-409/000-006](http://www.wago.com/2002-409/000-006)



**Item no.: 2002-409/000-005**  
Jumper; 9-way; insulated; red

[www.wago.com/2002-409/000-005](http://www.wago.com/2002-409/000-005)



**Item no.: 2002-409**  
Jumper; 9-way; insulated; light gray

[www.wago.com/2002-409](http://www.wago.com/2002-409)



**Item no.: 2002-423/000-006**  
Continuous jumper; from 1 to 3; insulated; blue

[www.wago.com/2002-423/000-006](http://www.wago.com/2002-423/000-006)



**Item no.: 2002-423**  
Continuous jumper; from 1 to 3; insulated; light gray

















[www.wago.com/2002-423](http://www.wago.com/2002-423)

















**Item no.: 2002-433**  
Jumper; from 1 to 3; insulated; light gray

[www.wago.com/2002-433](http://www.wago.com/2002-433)

Subject to changes. Please also observe the further product documentation!

	<b>Item no.: 2002-434</b> Jumper; from 1 to 4; insulated; light gray	<a href="http://www.wago.com/2002-434">www.wago.com/2002-434</a>
	<b>Item no.: 2002-423/000-005</b> Continuous jumper; from 1 to 3; insulated; red	<a href="http://www.wago.com/2002-423/000-005">www.wago.com/2002-423/000-005</a>
	<b>Item no.: 2002-435</b> Jumper; from 1 to 5; insulated; light gray	<a href="http://www.wago.com/2002-435">www.wago.com/2002-435</a>
	<b>Item no.: 2002-436</b> Jumper; from 1 to 6; insulated; light gray	<a href="http://www.wago.com/2002-436">www.wago.com/2002-436</a>
	<b>Item no.: 2002-437</b> Jumper; from 1 to 7; insulated; light gray	<a href="http://www.wago.com/2002-437">www.wago.com/2002-437</a>
	<b>Item no.: 2002-438</b> Jumper; from 1 to 8; insulated; light gray	<a href="http://www.wago.com/2002-438">www.wago.com/2002-438</a>
	<b>Item no.: 2002-439</b> Jumper; from 1 to 9; insulated; light gray	<a href="http://www.wago.com/2002-439">www.wago.com/2002-439</a>
	<b>Item no.: 2002-440</b> Jumper; from 1 to 10; insulated; light gray	<a href="http://www.wago.com/2002-440">www.wago.com/2002-440</a>
	<b>Item no.: 2002-472</b> Staggered jumper; 2-way; insulated; light gray	<a href="http://www.wago.com/2002-472">www.wago.com/2002-472</a>
	<b>Item no.: 2002-473</b> Staggered jumper; 3-way; insulated; light gray	<a href="http://www.wago.com/2002-473">www.wago.com/2002-473</a>
	<b>Item no.: 2002-475/011-000</b> Staggered jumper; 3-way; insulated; light gray	<a href="http://www.wago.com/2002-475/011-000">www.wago.com/2002-475/011-000</a>
	<b>Item no.: 2002-475</b> Staggered jumper; 5-way; insulated; light gray	<a href="http://www.wago.com/2002-475">www.wago.com/2002-475</a>
	<b>Item no.: 2002-476</b> Staggered jumper; 6-way; insulated; light gray	<a href="http://www.wago.com/2002-476">www.wago.com/2002-476</a>
	<b>Item no.: 2002-474</b> Staggered jumper; 4-way; insulated; light gray	<a href="http://www.wago.com/2002-474">www.wago.com/2002-474</a>
	<b>Item no.: 2002-477</b> Staggered jumper; 7-way; insulated; light gray	<a href="http://www.wago.com/2002-477">www.wago.com/2002-477</a>
	<b>Item no.: 2002-473/011-000</b> Staggered jumper; 2-way; from 1 to 3; insulated; light gray	<a href="http://www.wago.com/2002-473/011-000">www.wago.com/2002-473/011-000</a>

Subject to changes. Please also observe the further product documentation!

	<b>Item no.: 2002-479</b> Staggered jumper; 9-way; insulated; light gray	<a href="http://www.wago.com/2002-479">www.wago.com/2002-479</a>
	<b>Item no.: 2002-478</b> Staggered jumper; 8-way; insulated; light gray	<a href="http://www.wago.com/2002-478">www.wago.com/2002-478</a>
	<b>Item no.: 2002-479/011-000</b> Staggered jumper; insulated; light gray	<a href="http://www.wago.com/2002-479/011-000">www.wago.com/2002-479/011-000</a>
	<b>Item no.: 2002-480</b> Staggered jumper; 10-way; insulated; light gray	<a href="http://www.wago.com/2002-480">www.wago.com/2002-480</a>
	<b>Item no.: 2002-477/011-000</b> Staggered jumper; insulated; light gray	<a href="http://www.wago.com/2002-477/011-000">www.wago.com/2002-477/011-000</a>
	<b>Item no.: 2002-481/011-000</b> Staggered jumper; insulated; light gray	<a href="http://www.wago.com/2002-481/011-000">www.wago.com/2002-481/011-000</a>
	<b>Item no.: 2002-481</b> Staggered jumper; 11-way; insulated; light gray	<a href="http://www.wago.com/2002-481">www.wago.com/2002-481</a>
	<b>Item no.: 2002-482</b> Staggered jumper; 12-way; insulated; light gray	<a href="http://www.wago.com/2002-482">www.wago.com/2002-482</a>
	<b>Item no.: 210-103</b> Wire commoning chain; insulated; black	<a href="http://www.wago.com/210-103">www.wago.com/210-103</a>
	<b>Item no.: 2002-424/000-006</b> Continuous jumper; from 1 to 4; insulated; blue	<a href="http://www.wago.com/2002-424/000-006">www.wago.com/2002-424/000-006</a>
<b>Ferrule</b>		
Ferrule		
	<b>Item no.: 216-241</b> Ferrule; Sleeve for 0.5 mm <sup>2</sup> / 20 AWG; insulated; electro-tin plated; electrolytic copper; gastight crimped; acc. to DIN 46228, Part 4/09.90; white	<a href="http://www.wago.com/216-241">www.wago.com/216-241</a>
	<b>Item no.: 216-242</b> Ferrule; Sleeve for 0.75 mm <sup>2</sup> / 18 AWG; insulated; electro-tin plated; electrolytic copper; gastight crimped; acc. to DIN 46228, Part 4/09.90; gray	<a href="http://www.wago.com/216-242">www.wago.com/216-242</a>
	<b>Item no.: 216-243</b> Ferrule; Sleeve for 1 mm <sup>2</sup> / AWG 18; insulated; electro-tin plated; electrolytic copper; gastight crimped; acc. to DIN 46228, Part 4/09.90; red	<a href="http://www.wago.com/216-243">www.wago.com/216-243</a>
	<b>Item no.: 216-244</b> Ferrule; Sleeve for 1.5 mm <sup>2</sup> / AWG 16; insulated; electro-tin plated; electrolytic copper; gastight crimped; acc. to DIN 46228, Part 4/09.90; black	<a href="http://www.wago.com/216-244">www.wago.com/216-244</a>
	<b>Item no.: 216-263</b>	

Subject to changes. Please also observe the further product documentation!



Ferrule; Sleeve for 1 mm<sup>2</sup> / AWG 18; insulated; electro-tin plated; electrolytic copper; gastight crimped; acc. to DIN 46228, Part 4/09.90; red [www.wago.com/216-263](http://www.wago.com/216-263)

**Item no.: 216-246**

Ferrule; Sleeve for 2.5 mm<sup>2</sup> / AWG 14; insulated; electro-tin plated; electrolytic copper; gastight crimped; acc. to DIN 46228, Part 4/09.90; blue

[www.wago.com/216-246](http://www.wago.com/216-246)**Item no.: 216-266**

Ferrule; Sleeve for 2.5 mm<sup>2</sup> / AWG 14; insulated; electro-tin plated; electrolytic copper; gastight crimped; acc. to DIN 46228, Part 4/09.90; blue

[www.wago.com/216-266](http://www.wago.com/216-266)**Item no.: 216-264**

Ferrule; Sleeve for 1.5 mm<sup>2</sup> / AWG 16; insulated; electro-tin plated; electrolytic copper; gastight crimped; acc. to DIN 46228, Part 4/09.90; black

[www.wago.com/216-264](http://www.wago.com/216-264)**Item no.: 216-262**

Ferrule; Sleeve for 0.75 mm<sup>2</sup> / 18 AWG; insulated; electro-tin plated; electrolytic copper; gastight crimped; acc. to DIN 46228, Part 4/09.90; gray

[www.wago.com/216-262](http://www.wago.com/216-262)**Testing and measuring**

## Testing accessories

**Item no.: 2009-174**

Test plug adapter; for 4 mm Ø test plugs; for testing TOPJOB®S rail-mounted terminal blocks; gray

[www.wago.com/2009-174](http://www.wago.com/2009-174)**Item no.: 2009-182**

Testing tap; for max. 2.5 mm<sup>2</sup>; tool-free connection for individual test wires 0.08 - 2.5 mm; gray

[www.wago.com/2009-182](http://www.wago.com/2009-182)**Item no.: 2002-511**

Modular TOPJOB®S connector; modular; for jumper contact slot; 1-pole; 2,50 mm<sup>2</sup>; gray

[www.wago.com/2002-511](http://www.wago.com/2002-511)**Item no.: 2002-549**

Spacer module; modular; e.g., for bridging commoned terminal blocks; gray

[www.wago.com/2002-549](http://www.wago.com/2002-549)**Item no.: 2002-552**

Modular TOPJOB®S connector; modular; for jumper contact slot; 2-pole; 2,50 mm<sup>2</sup>; gray

[www.wago.com/2002-552](http://www.wago.com/2002-552)**Item no.: 2002-558**

Modular TOPJOB®S connector; modular; for jumper contact slot; 8-pole; 2,50 mm<sup>2</sup>; gray

[www.wago.com/2002-558](http://www.wago.com/2002-558)**Item no.: 2002-559**

Modular TOPJOB®S connector; modular; for jumper contact slot; 9-pole; 2,50 mm<sup>2</sup>; gray

[www.wago.com/2002-559](http://www.wago.com/2002-559)**Item no.: 2002-556**

Modular TOPJOB®S connector; modular; for jumper contact slot; 6-pole; 2,50 mm<sup>2</sup>; gray

[www.wago.com/2002-556](http://www.wago.com/2002-556)**Item no.: 2002-553**

Modular TOPJOB®S connector; modular; for jumper contact slot; 3-pole; 2,50 mm<sup>2</sup>; gray

[www.wago.com/2002-553](http://www.wago.com/2002-553)**Item no.: 2002-611**

TOPJOB®S L-type test plug module; modular; 1-pole; 2,50 mm<sup>2</sup>; gray

[www.wago.com/2002-611](http://www.wago.com/2002-611)**Item no.: 2002-560**

Modular TOPJOB®S connector; modular; for jumper contact slot; 10-pole; 2,50 mm<sup>2</sup>; gray

[www.wago.com/2002-560](http://www.wago.com/2002-560)**Item no.: 2002-554**

Subject to changes. Please also observe the further product documentation!



Modular TOPJOB®S connector; modular; for jumper contact slot; 4-pole; 2,50 mm<sup>2</sup>; gray

[www.wago.com/2002-554](http://www.wago.com/2002-554)



**Item no.: 2002-555**

Modular TOPJOB®S connector; modular; for jumper contact slot; 5-pole; 2,50 mm<sup>2</sup>; gray

[www.wago.com/2002-555](http://www.wago.com/2002-555)



**Item no.: 2002-557**

Modular TOPJOB®S connector; modular; for jumper contact slot; 7-pole; 2,50 mm<sup>2</sup>; gray

[www.wago.com/2002-557](http://www.wago.com/2002-557)



**Item no.: 2002-649**

TOPJOB®S L-type spacer module; modular; e.g., for bridging commoned terminal blocks; gray

[www.wago.com/2002-649](http://www.wago.com/2002-649)



**Item no.: 210-136**

Test plug; 2 mm Ø; with 500 mm cable; red

[www.wago.com/210-136](http://www.wago.com/210-136)

## Downloads

### Documentation

#### Bid Text

2102-1301 X81 - Datei	2019 May 15	xml 4.1 kB	Download
2102-1301 docx - Datei	2019 May 14	docx 15.1 kB	Download

#### Additional Information

Technical Section Technical explanations		pdf 2.2 MB	Download
---	--	---------------	----------

## CAD/CAE-Data

### CAD data

2D/3D Models 2102-1301		URL	Download
------------------------	--	-----	----------

### CAE data

EPLAN Data Portal 2102-1301		URL	Download
ZUKEN Portal 2102-1301		URL	Download

## Environmental Product Compliance

Subject to changes. Please also observe the further product documentation!

WAGO GmbH & Co. KG  
 Hansastr. 27  
 32423 Minden  
 Phone: +49571 887-0 | Fax: +49571 887-169  
 Email: [info.de@wago.com](mailto:info.de@wago.com) | Web: [www.wago.com](http://www.wago.com)

Do you have any questions about our products?  
 We are always happy to take your call at +49 (571) 887-44222.

## Compliance Search

Environmental Product Compliance 2102-1301

[URL](#)

[Download](#)

3-conductor through terminal block; with lever and Push-in CAGE CLAMP®; 2.5 mm<sup>2</sup>; with test port; side and center marking; for DIN-rail 35 x 15 and 35 x 7.5; Push-in CAGE CLAMP®; 2,50 mm<sup>2</sup>; gray

## Installation Notes

### Conductor termination

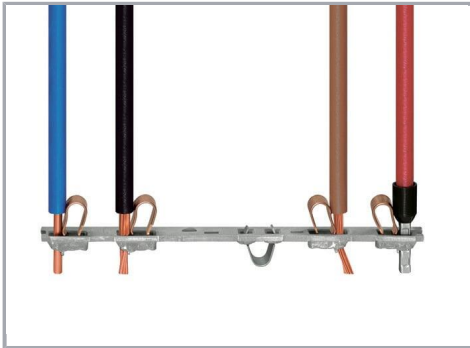

All conductor types at a glance

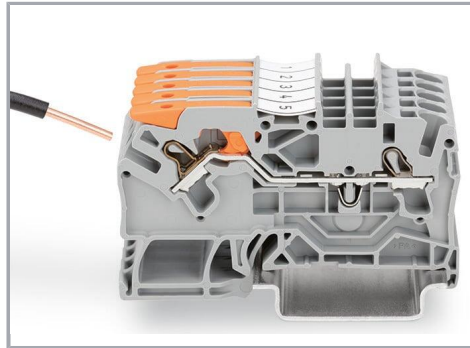

Push-in termination of solid conductors

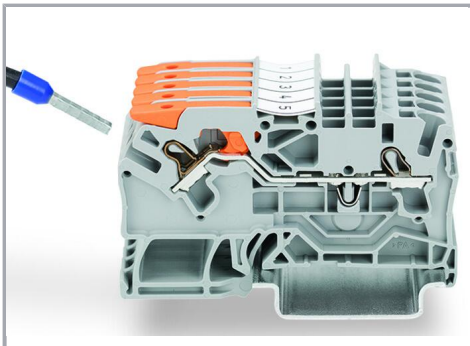

Push-in termination of fine-stranded conductors with ferrules

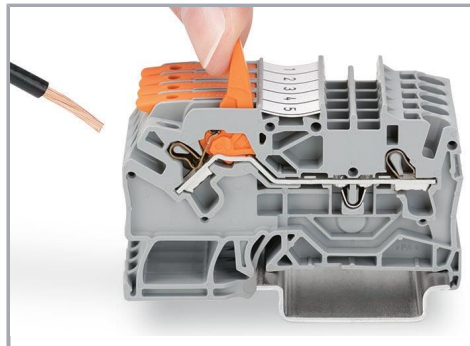

Pull the lever up until it stops, then connect the fine-stranded conductor.

Subject to changes. Please also observe the further product documentation!

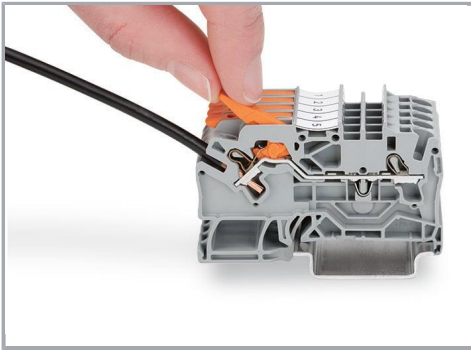

Push the lever back down – done!

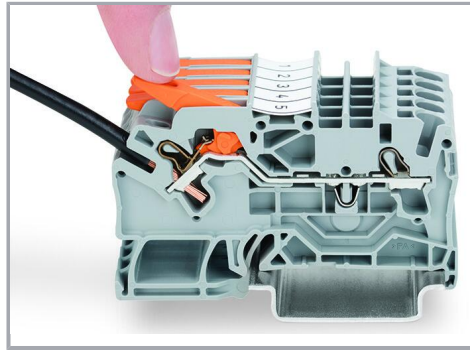

Push the lever back down – done!

### Commoning



Insert a push-in type jumper bar and push down until it hits the backstop.

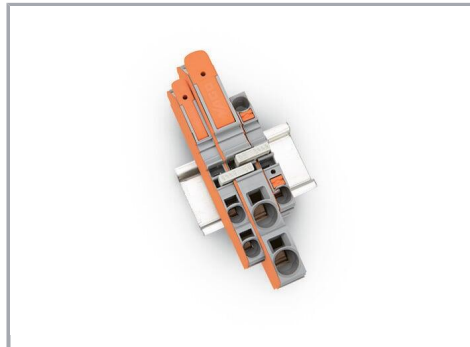

Commoning with step-down jumpers.

### Testing

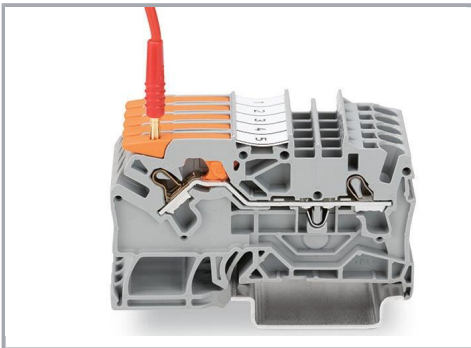

Testing with a 2 mm Ø test plug (max. 42 V).

### Marking

Subject to changes. Please also observe the further product documentation!

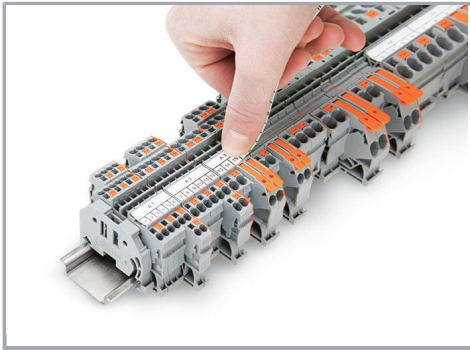

Snapping a marking strip into a marker slot.

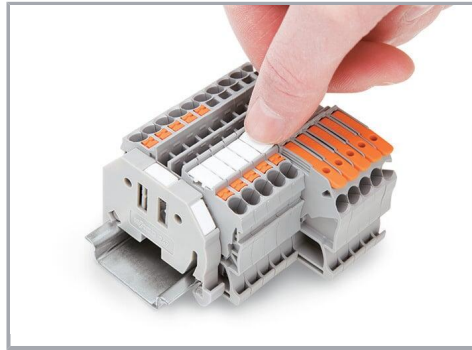

Snapping a marking strip into the marker slot.

## Product family

### TOPJOB® S

TOPJOB® S: In various industrial applications and modern building installations, WAGO's wide and versatile range of rail-mount terminal blocks provides more than just reliable electrical connections.

[Show all products from the family](#)

Subject to changes. Please also observe the further product documentation!