

L0603C39NJRMST

Aliases (L0603C39NJRMST)

Obsolete

KEMET, L-RMS, RF, 0.039 uH, 5%

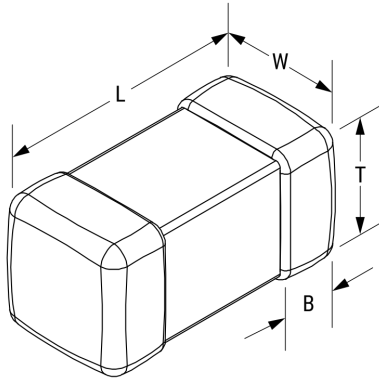

Click [here](#) for the 3D model.

Dimensions

Chip Size	0603
L	1.6mm +/-0.15mm
W	0.8mm +/-0.15mm
T	0.8mm +/-0.15mm
LL	0.3mm +/-0.2mm
B	0.3mm +/-0.2mm

Packaging Specifications

Packaging	T&R
Packaging Quantity	4000

General Information

Series	L-RMS
Style	SMD Chip
Description	Surface Mount Inductor
RoHS	Yes
Core	Ceramic
Winding Type	Multilayer
Notes	Suggested Replacement - https://www.chilisin.com/en-global/Inductor/Product/BSCH_160808/BSCH0016080839NJ00 .

Specifications

Inductance	0.039 uH
Inductance Tolerance	5%
Temperature Range	-40/+85°C
Current	300 mAmps (MAX)
DC Resistance	0.6 Ohms
Quality Factor	18 at 100 MHz, 39 at 500 MHz, 44 at 800 MHz, 44 at 1000 MHz
Self-Resonant Frequency	1100 MHz