

Data sheet | Item number: 870-523/281-582

Component terminal block; double-deck; with varistor; for DIN-rail 35 x 15 and 35 x 7.5; 2.5 mm²; CAGE CLAMP®; 2,50 mm²; gray

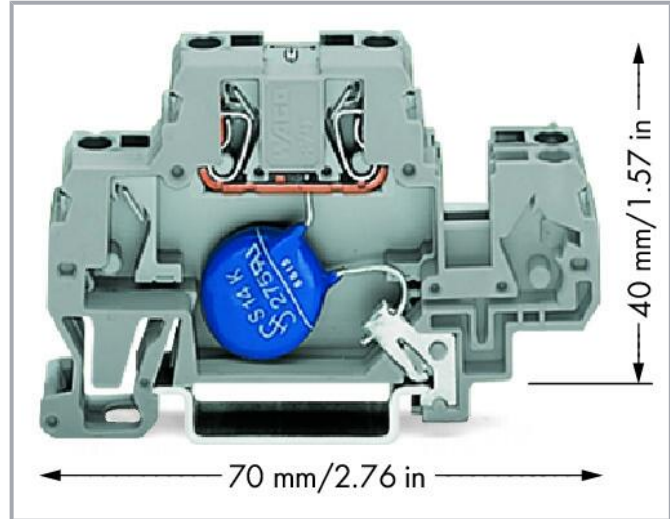

www.wago.com/870-523/281-582

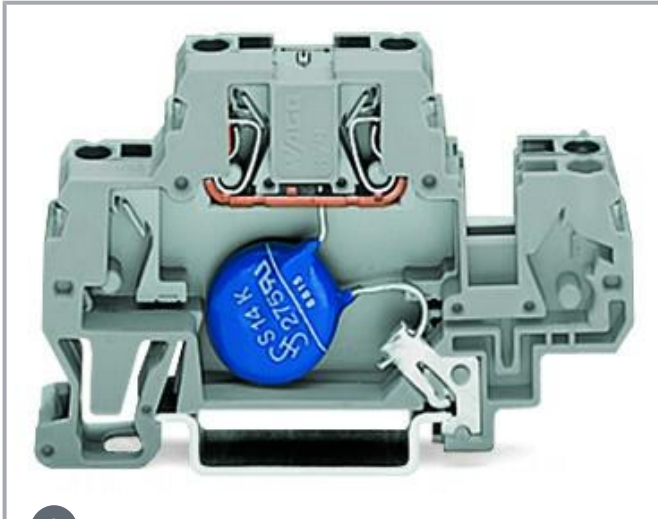

i Picture differs from the item.

Color: —

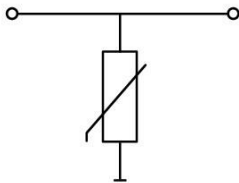

Data

Electrical data

Nominal operating voltage	DC 24 V
Highest continuous voltage	DC 31 V
Rated continuous current	20 A
Nominal discharge current (8/20 µs) (line)	300 A
Discharge current (max.)	1 kA
Protection level (8/20 µs)	≤ DC 77 V

Subject to changes. Please also observe the further product documentation!

WAGO GmbH & Co. KG
Hansastr. 27
32423 Minden
Phone: +49571 887-0 | Fax: +49571 887-169
Email: info.de@wago.com | Web: www.wago.com

Do you have any questions about our products?
We are always happy to take your call at +49 (571) 887-44222.



Capacitance	≤ 4.6 nF
-------------	----------

Connection data

Connections (number)	2
Connection technology	CAGE CLAMP®
Solid conductor	0.08 ... 2.5 mm ² / 28 ... 14 AWG
Fine-stranded conductor	0.08 ... 4 mm ² / 28 ... 12 AWG
Fine-stranded conductor; with insulated ferrule	0.08 ... 1.5 mm ² / 28 ... 14 AWG
Strip length	6 ... 7 mm / 0.24 ... 0.28 inches

Physical data

Width	10 mm / 0.394 inches
Height from upper-edge of DIN-rail	40 mm / 1.575 inches
Depth	70 mm / 2.756 inches

Mechanical Data

Mounting type	DIN-35 rail
---------------	-------------

Material Data

Color	gray
Insulation material	Polyamide (PA66)
Material group	I
Flammability class per UL94	V0
Fire load	0.257 MJ
Weight	12.2 g

Environmental requirements

Processing temperature	-35 ... +85 °C
------------------------	----------------

Commercial data

Product Group	16 (Rail Mounted Terminal Blocks with CCC)
eCl@ss 10.0	27-14-11-27
eCl@ss 9.0	27-14-11-27
ETIM 8.0	EC000903
ETIM 7.0	EC000903

Subject to changes. Please also observe the further product documentation!

WAGO GmbH & Co. KG
 Hansastr. 27
 32423 Minden
 Phone: +49571 887-0 | Fax: +49571 887-169
 Email: info.de@wago.com | Web: www.wago.com

Do you have any questions about our products?
 We are always happy to take your call at +49 (571) 887-44222.

PU (SPU)	25 pcs
Packaging type	box
Country of origin	DE
GTIN	4045454308117
Customs tariff number	85369010000

Environmental Product Compliance

RoHS Compliance Status	Compliant, No Exemption
------------------------	-------------------------

Optional accessories

Marking accessories

Marker	
--------	--

	Item no.: 2009-145 Mini-WSB Inline; for Smart Printer; 1700 pieces on roll; stretchable 5 - 5.2 mm; plain; snap-on type; white	www.wago.com/2009-145
--	--	--

	Item no.: 248-501 Mini-WSB marking card; as card; not stretchable; plain; snap-on type; white	www.wago.com/248-501
--	---	--

Tool	
Operating tool	

	Item no.: 210-720 Operating tool; Blade: 3.5 x 0.5 mm; with a partially insulated shaft; multicoloured	www.wago.com/210-720
--	--	--

Insulation stop	
Insulation stop	

	Item no.: 280-472 Insulation stop; 0.75 - 1 mm ² ; 5 pieces/strip; black	www.wago.com/280-472
--	---	--

	Item no.: 280-470 Insulation stop; 0.08 - 0.2 mm ² "s" (0.14 mm ² "f-st"); 5 pieces/strip; white	www.wago.com/280-470
--	--	--

	Item no.: 280-471 Insulation stop; 0.25 - 0.5 mm ² ; 5 pieces/strip; light gray	www.wago.com/280-471
--	--	--

End plate	
End plate	

	Item no.: 870-518 End and intermediate plate; 2 mm thick; gray	www.wago.com/870-518
--	--	--

	Item no.: 870-519 End and intermediate plate; 2 mm thick; orange	www.wago.com/870-519
--	--	--

Subject to changes. Please also observe the further product documentation!



Jumpers

Jumper

	Item no.: 280-492 Jumper; 2-way; insulated; gray	www.wago.com/280-492
---	--	--

Downloads

Documentation

Bid Text

870-523/281-582 X81 - Datei	2019 Feb 19	xml 3.5 kB	Download
870-523/281-582 doc - Datei	2015 Feb 11	doc 26.6 kB	Download

Additional Information

Disposal and Recycling Electrical and electronic equipment, Batteries, Packaging	V 1.1.0 2022 Aug 18	pdf 2.2 MB	Download
---	------------------------	---------------	----------

CAD/CAE-Data

CAE data

EPLAN Data Portal 870-523/281-582		URL	Download
WSCAD Universe 870-523/281-582		URL	Download
ZUKEN Portal 870-523/281-582		URL	Download
EPLAN Data Portal 870-523/281-582		URL	Download
WSCAD Universe 870-523/281-582		URL	Download

CAD data

2D/3D Models 870-523/281-582		URL	Download
------------------------------	--	-----	----------

Environmental Product Compliance

Compliance Search

Subject to changes. Please also observe the further product documentation!

WAGO GmbH & Co. KG
 Hansastr. 27
 32423 Minden
 Phone: +49571 887-0 | Fax: +49571 887-169
 Email: info.de@wago.com | Web: www.wago.com

Do you have any questions about our products?
 We are always happy to take your call at +49 (571) 887-44222.

Data sheet | Item number: 870-523/281-582

www.wago.com/870-523/281-582



[URL](#)

[Download](#)

Environmental Product Compliance 870-523/281-582

Component terminal block; double-deck; with varistor; for DIN-rail 35 x 15 and 35 x 7.5; 2.5 mm²; CAGE CLAMP®; 2,50 mm²; gray

Installation Notes

Subject to changes. Please also observe the further product documentation!

WAGO GmbH & Co. KG

Hansastr. 27

32423 Minden

Phone: +49571 887-0 | Fax: +49571 887-169

Email: info.de@wago.com | Web: www.wago.com

Do you have any questions about our products?

We are always happy to take your call at +49 (571) 887-44222.