

Order Code	TCK-092
Inductance (each winding)	45 μ H \pm 35% (at 100 kHz / 100 mV)
Impedance (DCR)	2 m Ω max.
Rated Current	31.4 A max.
Rated Voltage	500 VDC max. (between windings)
Operating Temperature	-40°C to +105°C
RoHS Exemptions	No Exemptions

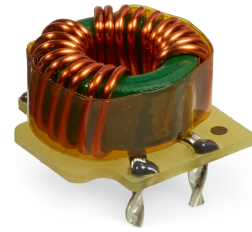

Impedance Curve

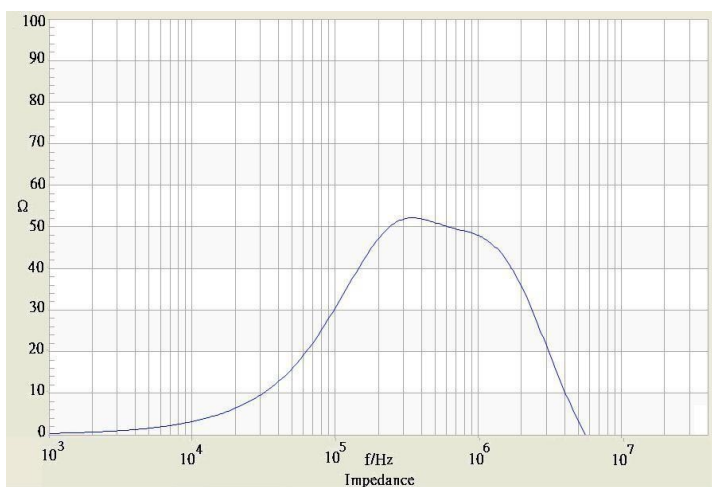

Outline Dimensions

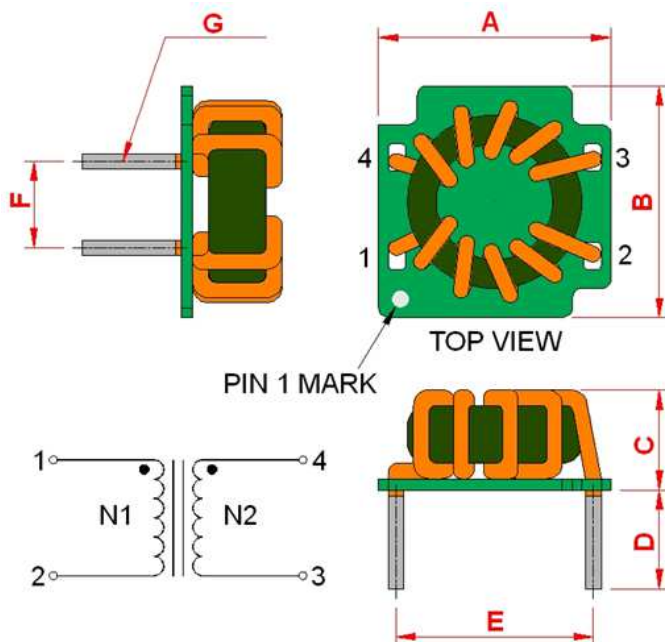

Dimensions [mm]

A	16.6 \pm 0.4
B	16.4 \pm 0.4
C	12.5 max.
D	5.0 \pm 1.0
E	14.1 \pm 0.5
F	6.1 \pm 0.5
G	\varnothing 2.2 max.

All specifications valid at +25°C, unless otherwise stated.