

NPN Transistor with Zener Diode

NSM6056MT1G

Features

- These Devices are Pb-Free, Halogen Free/BFR Free and are RoHS Compliant

Typical Applications

- Driving Circuit
- Switching Applications

MAXIMUM RATINGS – NPN TRANSISTOR

Rating	Symbol	Value	Unit
Collector – Emitter Voltage	V_{CEO}	40	V
Collector – Base Voltage	V_{CBO}	60	V
Emitter – Base Voltage	V_{EBO}	6.0	V
Collector Current – Continuous	I_C	600	mA
Collector Current – Peak	I_{CM}	900	mA

MAXIMUM RATINGS – ZENER DIODE

Rating	Symbol	Value	Unit
Forward Voltage @ $I_F = 10\text{ mA}$	V_F	0.9	V

THERMAL CHARACTERISTICS

Rating	Symbol	Max	Unit
Total Device Dissipation FR-5 Board, (Note 1) @ $T_A = 25^\circ\text{C}$	P_D	380	mW
Thermal Resistance from Junction-to-Ambient	$R_{\theta JA}$	328	$^\circ\text{C/W}$
Junction and Storage Temperature Range	T_J, T_{stg}	-55 to +150	$^\circ\text{C}$

Stresses exceeding those listed in the Maximum Ratings table may damage the device. If any of these limits are exceeded, device functionality should not be assumed, damage may occur and reliability may be affected.

1. FR-4 Minimum Pad.

NPN Transistor with Zener Diode

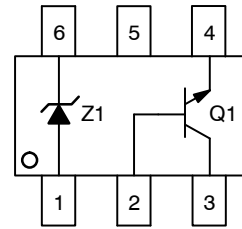

PINOUT:
PIN 1. ANODE
2. BASE
3. COLLECTOR
4. EMITTER
5. NC/COLLECTOR
6. CATHODE

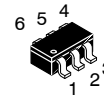

SC-74
CASE 318F

MARKING DIAGRAM

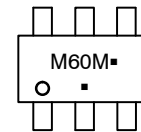

M60 = Device Code
M = Date Code*
• = Pb-Free Package

(Note: Microdot may be in either location)

*Date Code orientation may vary depending upon manufacturing location.

ORDERING INFORMATION

Device	Package	Shipping [†]
NSM6056MT1G	SC-74 (Pb-Free)	3000/Tape & Reel

[†]For information on tape and reel specifications, including part orientation and tape sizes, please refer to our Tape and Reel Packaging Specification Brochure, BRD8011/D.

NSM6056MT1G

NPN TRANSISTOR – ELECTRICAL CHARACTERISTICS (T_A = 25°C unless otherwise noted)

Characteristic	Symbol	Min	Max	Unit
OFF CHARACTERISTICS				
Collector – Emitter Breakdown Voltage (Note 3) (I _C = 1.0 mA _{dc} , I _B = 0)	V _{(BR)CEO}	40	–	V _{dc}
Collector – Base Breakdown Voltage (I _C = 0.1 mA _{dc} , I _E = 0)	V _{(BR)CBO}	60	–	V _{dc}
Emitter – Base Breakdown Voltage (I _E = 0.1 mA _{dc} , I _C = 0)	V _{(BR)EBO}	6.0	–	V _{dc}
Base Cutoff Current (V _{CE} = 35 V _{dc} , V _{EB} = 0.4 V _{dc})	I _{BEV}	–	0.1	μA _{dc}
Collector Cutoff Current (V _{CE} = 35 V _{dc} , V _{EB} = 0.4 V _{dc})	I _{CEX}	–	0.1	μA _{dc}

ON CHARACTERISTICS (Note 3)

DC Current Gain (I _C = 0.1 mA _{dc} , V _{CE} = 1.0 V _{dc}) (I _C = 1.0 mA _{dc} , V _{CE} = 1.0 V _{dc}) (I _C = 10 mA _{dc} , V _{CE} = 1.0 V _{dc}) (I _C = 150 mA _{dc} , V _{CE} = 1.0 V _{dc}) (I _C = 500 mA _{dc} , V _{CE} = 2.0 V _{dc})	h _{FE}	20 40 80 100 40	– – – 300 –	–
Collector – Emitter Saturation Voltage (I _C = 150 mA _{dc} , I _B = 15 mA _{dc}) (I _C = 500 mA _{dc} , I _B = 50 mA _{dc})	V _{CE(sat)}	– –	0.4 0.75	V _{dc}
Base – Emitter Saturation Voltage (I _C = 150 mA _{dc} , I _B = 15 mA _{dc}) (I _C = 500 mA _{dc} , I _B = 50 mA _{dc})	V _{BE(sat)}	0.75 –	0.95 1.2	V _{dc}

SMALL – SIGNAL CHARACTERISTICS

Current – Gain – Bandwidth Product (I _C = 20 mA _{dc} , V _{CE} = 10 V _{dc} , f = 100 MHz)	f _T	250	–	MHz
Collector – Base Capacitance (V _{CB} = 5.0 V _{dc} , I _E = 0, f = 1.0 MHz)	C _{cb}	–	6.5	pF
Emitter – Base Capacitance (V _{EB} = 0.5 V _{dc} , I _C = 0, f = 1.0 MHz)	C _{eb}	–	30	pF
Input Impedance (I _C = 1.0 mA _{dc} , V _{CE} = 10 V _{dc} , f = 1.0 kHz)	h _{ie}	1.0	15	kΩ
Voltage Feedback Ratio (I _C = 1.0 mA _{dc} , V _{CE} = 10 V _{dc} , f = 1.0 kHz)	h _{re}	0.1	8.0	X 10 ⁻⁴
Small – Signal Current Gain (I _C = 1.0 mA _{dc} , V _{CE} = 10 V _{dc} , f = 1.0 kHz)	h _{fe}	40	500	–
Output Admittance (I _C = 1.0 mA _{dc} , V _{CE} = 10 V _{dc} , f = 1.0 kHz)	h _{oe}	1.0	30	μmhos

SWITCHING CHARACTERISTICS

Delay Time	(V _{CC} = 30 V _{dc} , V _{EB} = 2.0 V _{dc} , I _C = 150 mA _{dc} , I _{B1} = 15 mA _{dc})	t _d	–	15	ns
Rise Time		t _r	–	20	
Storage Time	(V _{CC} = 30 V _{dc} , I _C = 150 mA _{dc} , I _{B1} = I _{B2} = 15 mA _{dc})	t _s	–	225	ns
Fall Time		t _f	–	30	

2. Pulse Test: Pulse Width ≤ 300 μs, Duty Cycle ≤ 2.0%.

ZENER DIODE – ELECTRICAL CHARACTERISTICS (V_F = 0.9 Max @ I_F = 10 mA for all types)

Device	Test Current I _{zt} mA	Zener Voltage V _Z		Z _{ZK} I _Z = 0.5 mA Ω Max	Z _{ZT} I _Z = I _{ZT} @ 10% Mod Ω Max	Max IR @ V _R		dV _Z /dt (mV/k) @ I _{ZT1} = 5 mA		C pF Max @ V _R = 0 f = 1 MHz
		Min	Max			μA	V	Min	Max	
NSM6056MT1G	5.0	5.49	5.73	200	40	1.0	2.0	-2.0	2.5	200

NSM6056MT1G

TYPICAL ELECTRICAL CHARACTERISTICS – NPN TRANSISTOR

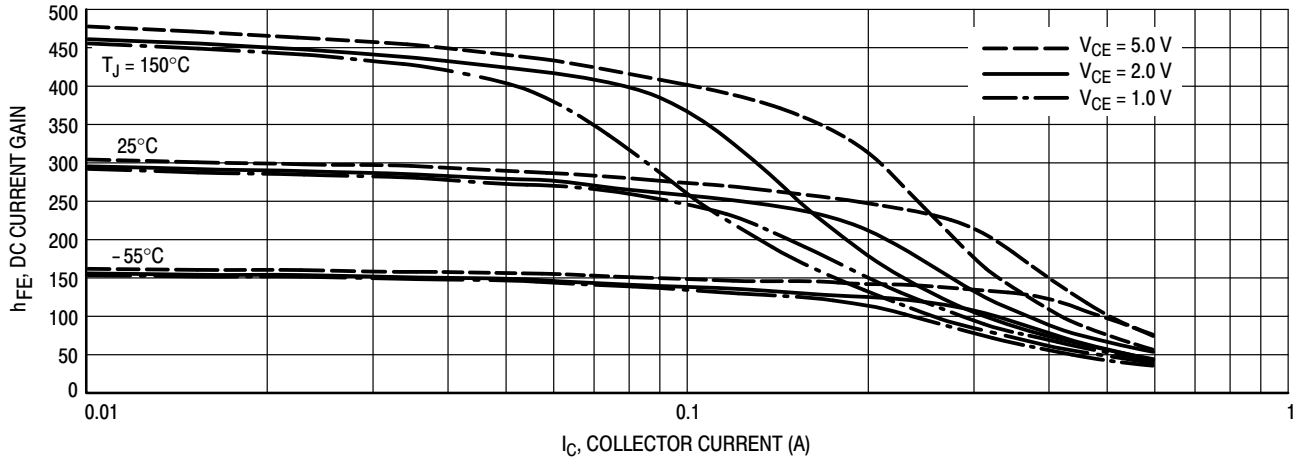

Figure 1. DC Current Gain

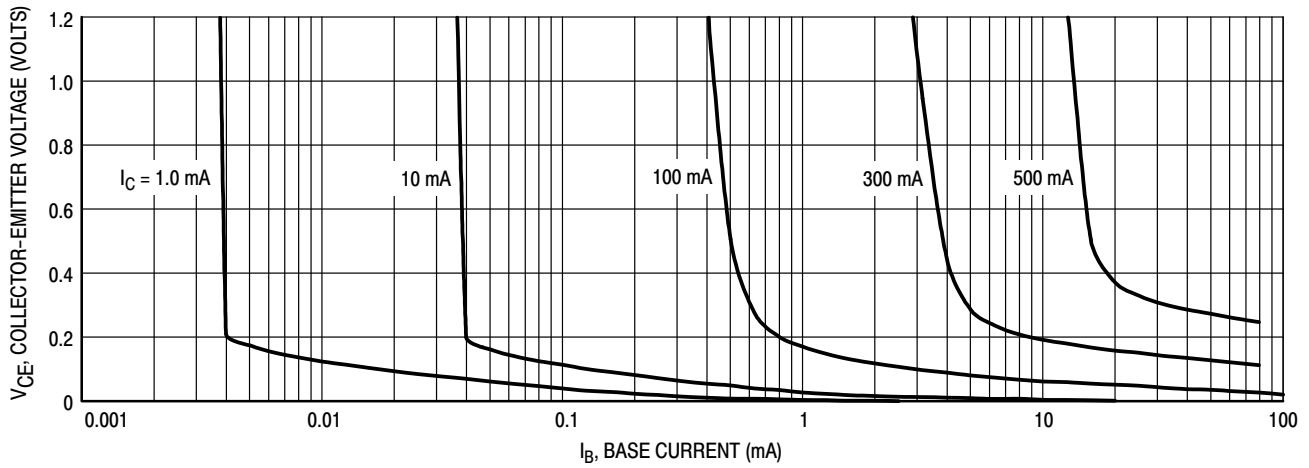

Figure 2. Collector Saturation Region

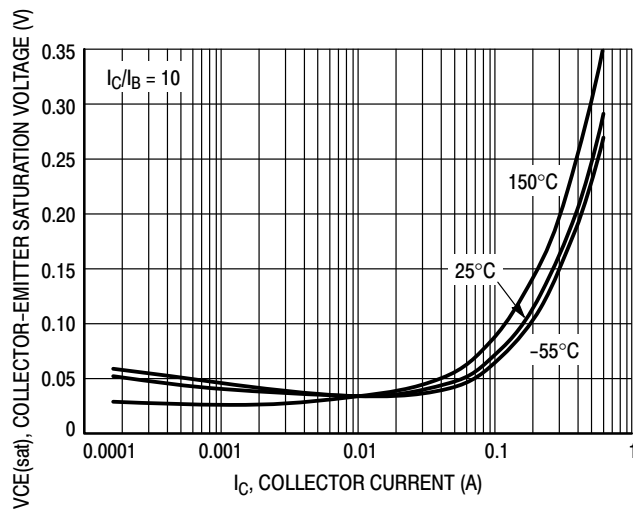

Figure 3. Collector-Emitter Saturation Voltage vs. Collector Current

NSM6056MT1G

TYPICAL ELECTRICAL CHARACTERISTICS – NPN TRANSISTOR

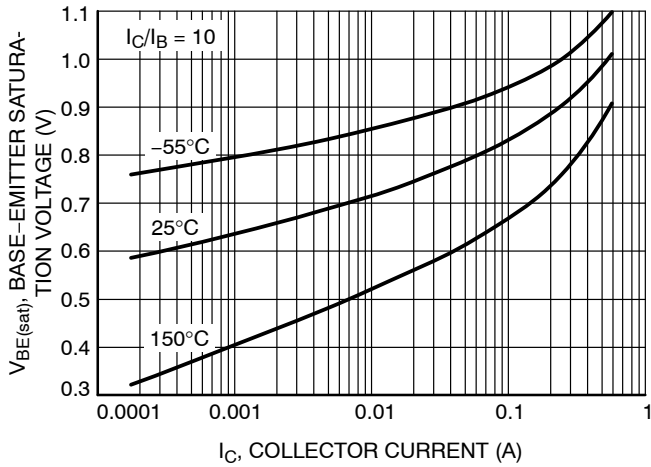

Figure 4. Base-Emitter Saturation Voltage vs. Collector Current

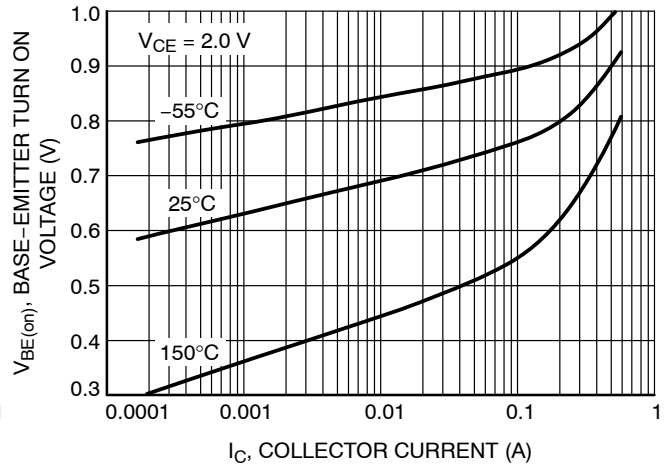

Figure 5. Base-Emitter Turn On Voltage vs. Collector Current

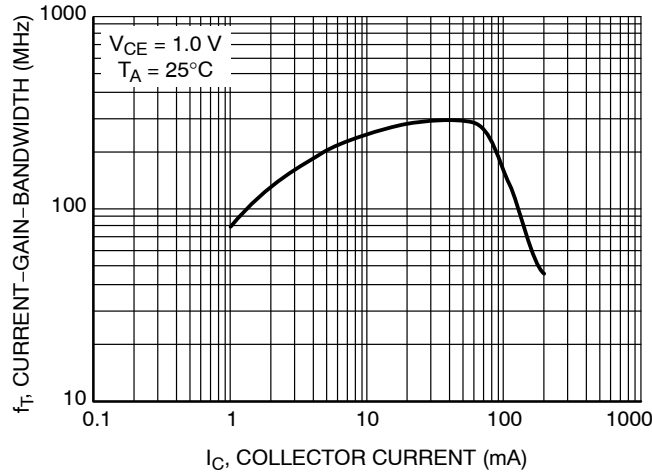

Figure 6. Current-Gain-Bandwidth Product

TYPICAL ELECTRICAL CHARACTERISTICS – ZENER DIODE

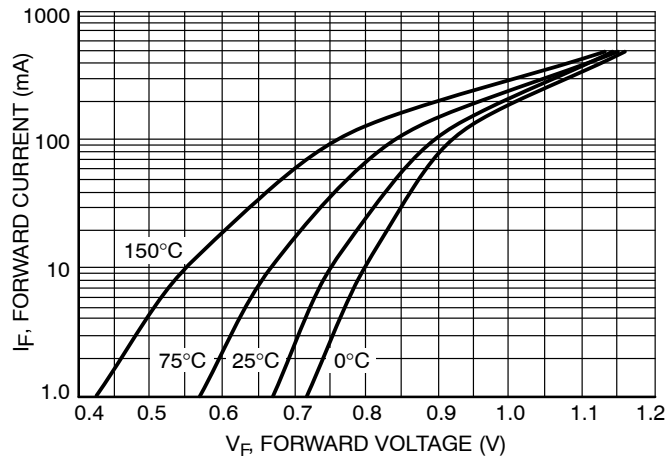

Figure 7. Typical Forward Voltage

MECHANICAL CASE OUTLINE PACKAGE DIMENSIONS



SCALE 2:1

SC-74
CASE 318F
ISSUE P

DATE 07 OCT 2021

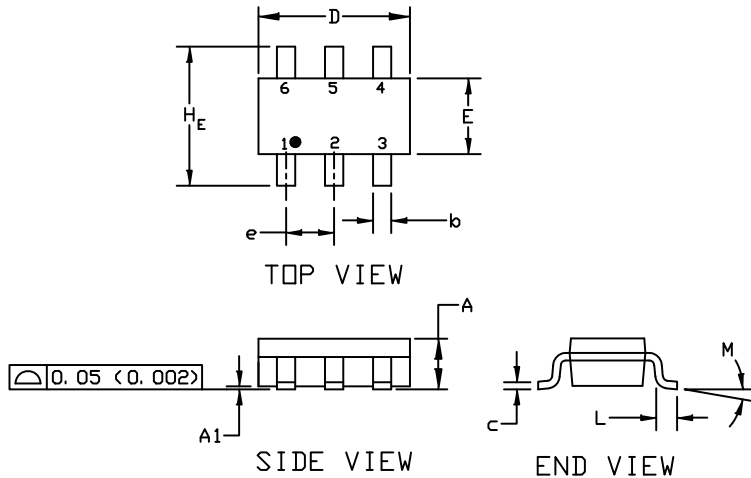

NOTES:

1. DIMENSIONING AND TOLERANCING PER ASME Y14.5M, 1994
2. CONTROLLING DIMENSION: INCHES
3. MAXIMUM LEAD THICKNESS INCLUDES LEAD FINISH THICKNESS. MINIMUM LEAD THICKNESS IS THE MINIMUM THICKNESS OF THE BASE MATERIAL.

DIM	MILLIMETERS			INCHES		
	MIN.	NOM.	MAX.	MIN.	NOM.	MAX.
A	0.90	1.00	1.10	0.035	0.039	0.043
A1	0.01	0.06	0.10	0.001	0.002	0.004
b	0.25	0.37	0.50	0.010	0.015	0.020
c	0.10	0.18	0.26	0.004	0.007	0.010
D	2.90	3.00	3.10	0.114	0.118	0.122
E	1.30	1.50	1.70	0.051	0.059	0.067
e	0.85	0.95	1.05	0.034	0.037	0.041
HE	2.50	2.75	3.00	0.099	0.108	0.118
L	0.20	0.40	0.60	0.008	0.016	0.024
M	0*	---	10*	0*	---	10*

GENERIC MARKING DIAGRAM*

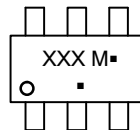

- XXX = Specific Device Code
- M = Date Code
- = Pb-Free Package

(Note: Microdot may be in either location)

*This information is generic. Please refer to device data sheet for actual part marking. Pb-Free indicator, "G" or microdot "▪", may or may not be present. Some products may not follow the Generic Marking.

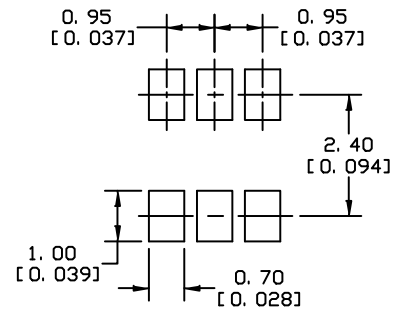

* For additional information on our Pb-Free strategy and soldering details, please download the DN Semiconductor Soldering and Mounting Techniques Reference Manual, SOLDERM/D.

SOLDERING FOOTPRINT

- | | | | | | |
|---|--|---|--|---|---|
| <p>STYLE 1:
PIN 1. CATHODE
2. ANODE
3. CATHODE
4. CATHODE
5. ANODE
6. CATHODE</p> | <p>STYLE 2:
PIN 1. NO CONNECTION
2. COLLECTOR
3. EMITTER
4. NO CONNECTION
5. COLLECTOR
6. BASE</p> | <p>STYLE 3:
PIN 1. EMITTER 1
2. BASE 1
3. COLLECTOR 2
4. EMITTER 2
5. BASE 2
6. COLLECTOR 1</p> | <p>STYLE 4:
PIN 1. COLLECTOR 2
2. EMITTER 1/EMITTER 2
3. COLLECTOR 1
4. EMITTER 3
5. BASE 1/BASE 2/COLLECTOR 3
6. BASE 3</p> | <p>STYLE 5:
PIN 1. CHANNEL 1
2. ANODE
3. CHANNEL 2
4. CHANNEL 3
5. CATHODE
6. CHANNEL 4</p> | <p>STYLE 6:
PIN 1. CATHODE
2. ANODE
3. CATHODE
4. CATHODE
5. CATHODE
6. CATHODE</p> |
| <p>STYLE 7:
PIN 1. SOURCE 1
2. GATE 1
3. DRAIN 2
4. SOURCE 2
5. GATE 2
6. DRAIN 1</p> | <p>STYLE 8:
PIN 1. EMITTER 1
2. BASE 2
3. COLLECTOR 2
4. EMITTER 2
5. BASE 1
6. COLLECTOR 1</p> | <p>STYLE 9:
PIN 1. EMITTER 2
2. BASE 2
3. COLLECTOR 1
4. EMITTER 1
5. BASE 1
6. COLLECTOR 2</p> | <p>STYLE 10:
PIN 1. ANODE/CATHODE
2. BASE
3. EMITTER
4. COLLECTOR
5. ANODE
6. CATHODE</p> | <p>STYLE 11:
PIN 1. EMITTER
2. BASE
3. ANODE/CATHODE
4. ANODE
5. CATHODE
6. COLLECTOR</p> | |

DOCUMENT NUMBER:	98ASB42973B	Electronic versions are uncontrolled except when accessed directly from the Document Repository. Printed versions are uncontrolled except when stamped "CONTROLLED COPY" in red.
DESCRIPTION:	SC-74	PAGE 1 OF 1

onsemi and ONSEMI are trademarks of Semiconductor Components Industries, LLC dba onsemi or its subsidiaries in the United States and/or other countries. onsemi reserves the right to make changes without further notice to any products herein. onsemi makes no warranty, representation or guarantee regarding the suitability of its products for any particular purpose, nor does onsemi assume any liability arising out of the application or use of any product or circuit, and specifically disclaims any and all liability, including without limitation special, consequential or incidental damages. onsemi does not convey any license under its patent rights nor the rights of others.

onsemi, **Onsemi**, and other names, marks, and brands are registered and/or common law trademarks of Semiconductor Components Industries, LLC dba "**onsemi**" or its affiliates and/or subsidiaries in the United States and/or other countries. **onsemi** owns the rights to a number of patents, trademarks, copyrights, trade secrets, and other intellectual property. A listing of **onsemi**'s product/patent coverage may be accessed at www.onsemi.com/site/pdf/Patent-Marking.pdf. **onsemi** reserves the right to make changes at any time to any products or information herein, without notice. The information herein is provided "as-is" and **onsemi** makes no warranty, representation or guarantee regarding the accuracy of the information, product features, availability, functionality, or suitability of its products for any particular purpose, nor does **onsemi** assume any liability arising out of the application or use of any product or circuit, and specifically disclaims any and all liability, including without limitation special, consequential or incidental damages. Buyer is responsible for its products and applications using **onsemi** products, including compliance with all laws, regulations and safety requirements or standards, regardless of any support or applications information provided by **onsemi**. "Typical" parameters which may be provided in **onsemi** data sheets and/or specifications can and do vary in different applications and actual performance may vary over time. All operating parameters, including "Typicals" must be validated for each customer application by customer's technical experts. **onsemi** does not convey any license under any of its intellectual property rights nor the rights of others. **onsemi** products are not designed, intended, or authorized for use as a critical component in life support systems or any FDA Class 3 medical devices or medical devices with a same or similar classification in a foreign jurisdiction or any devices intended for implantation in the human body. Should Buyer purchase or use **onsemi** products for any such unintended or unauthorized application, Buyer shall indemnify and hold **onsemi** and its officers, employees, subsidiaries, affiliates, and distributors harmless against all claims, costs, damages, and expenses, and reasonable attorney fees arising out of, directly or indirectly, any claim of personal injury or death associated with such unintended or unauthorized use, even if such claim alleges that **onsemi** was negligent regarding the design or manufacture of the part. **onsemi** is an Equal Opportunity/Affirmative Action Employer. This literature is subject to all applicable copyright laws and is not for resale in any manner.

ADDITIONAL INFORMATION

TECHNICAL PUBLICATIONS:

Technical Library: www.onsemi.com/design/resources/technical-documentation
onsemi Website: www.onsemi.com

ONLINE SUPPORT: www.onsemi.com/support

For additional information, please contact your local Sales Representative at www.onsemi.com/support/sales

