

**ECN/PCN No.: 4114**

For Manufacturer			
<b>Product Description:</b> PLASTIC SMD MEMS OSCILLATOR	<b>Abracon Part Number / Part Series:</b> ASTMLP	<input type="checkbox"/> Documentation only <input type="checkbox"/> ECN <input checked="" type="checkbox"/> EOL	<input checked="" type="checkbox"/> Series <input type="checkbox"/> Part Number
<b>Affected Revision:</b> I.R.	<b>New Revision:</b> EOL	<b>Application:</b>	<input type="checkbox"/> Safety <input checked="" type="checkbox"/> Non-Safety
<b>Prior to Change:</b> Active <a href="https://abracon.com/Oscillators/ASTMLP.pdf">https://abracon.com/Oscillators/ASTMLP.pdf</a>			
<b>After Change:</b> EOL			
<b>Cause/Reason for Change:</b> Discontinuation of manufacturing capability.			
Change Plan			
<b>Effective Date:</b> 2/7/2022	<b>Additional Remarks:</b> N/A		
<b>Change Declaration:</b> N/A			
<b>Issued Date:</b> 2/7/2022	<b>Issued By:</b>	<b>Issued Department:</b>	
<b>Approval:</b>	<b>Approval:</b>	<b>Approval:</b>	
For Abracon EOL only			
<b>Last Time Buy (if applicable):</b> 5/7/2022	<b>Alternate Part Number / Part Series:</b> ASADV (2.0x1.6mm), ASDDV (2.5x2.0mm), ASEDV (3.2x2.5mm), ASFLDV (5.0x3.2mm), ASVDV (7.0x5.0mm)		
<b>Additional Approval:</b>	<b>Additional Approval:</b>	<b>Additional Approval:</b>	
Customer Approval (If Applicable)			
<b>Qualification Status:</b> <input type="checkbox"/> Approved <input type="checkbox"/> Not accepted <i>Note: It is considered approved if there is no feedback from the customer 1 month after ECN/PCN is released.</i>			
<b>Customer Part Number:</b>		<b>Customer Project:</b>	
<b>Company Name:</b>	<b>Company Representative:</b>	<b>Representative Signature:</b>	
<b>Customer Remarks:</b>			

# Low power, Programmable SMD MEMS Oscillator



2.0 x 1.6 x 0.75mm; 2.5 x 2.0 x 0.75mm;  
3.2 x 2.5 x 0.75mm; 5.0 x 3.2 x 0.75mm;  
7.0 x 5.0 x 0.9mm

ASTMLP



RoHS/RoHS II compliant

Moisture Sensitivity Level (MSL) – 1

## FEATURES:

- Industry Standard package sizes: 2.0 x 1.6 x 0.75mm, 2.5 x 2.0 x 0.75mm, 3.2 x 2.5 x 0.75mm, 5 x 3.2 x 0.75mm, 7.0 x 5.0 x 0.9mm
- Any frequency between 1MHz and 137MHz
- Supply Voltage options: 3.3V, 3.0V, 2.8V, 2.5V, 1.8V, 2.25V ~ 3.63V
- Low Current Consumption: 3.5mA typ. (@20MHz, 1.8V, no load); 4.9mA typ. (@125MHz, 1.8V, no load)
- Frequency Stability options:  $\pm 20$ ppm,  $\pm 25$ ppm,  $\pm 50$ ppm over -20 to +70°C and -40 to +85°C
- Factory programmable drive strength for improved jitter, reduced EMI or higher capacitive output load

## APPLICATIONS:

- GPON, EPON
- Portable devices
- Consumer electronics
- Network switches, router, servers
- Ethernet, USB, SATA, SAS, Firewire
- Harsh environment (vibration, shock-prone and humid)

## STANDARD SPECIFICATIONS:

All Min and Max limits are specified over temperature and rated operating voltage with 15pF output load unless otherwise stated. Typical values are at 25°C and nominal supply voltage.

Parameters	Min	Typ	Max	Unit	Notes
Output Frequency Range (F)	1		110	MHz	
	115		137		
Standard Frequencies	See Section 1.1 for Standard Frequencies			MHz	
Frequency Stability ( $F_{stab}$ )	-20		+20	ppm	Inclusive of initial tolerance at 25°C, 1 <sup>st</sup> year aging at 25°C, and variations over operating temperature, rated power supply voltage and load (15pF $\pm$ 10%)
	-25		+25		
	-50		+50		
Operating Temperature Range ( $T_{use}$ )	-20		+70	°C	Option "E"
	-40		+85		Option "L"
Supply Voltage ( $V_{dd}$ )	1.62	1.8	1.98	V	Option "18"
	2.25	2.5	2.75		Option "25"
	2.52	2.8	3.08		Option "28"
	2.7	3.0	3.3		Option "30"
	2.97	3.3	3.63		Option "33"
	2.25		3.63		Option "Blank" (default)
Current Consumption ( $I_{dd}$ )		3.8	4.5	mA	No load, F=20MHz, $V_{dd}$ =2.8V,3.0V,3.3V or 2.25V-3.63V
		3.7	4.2		No load, F=20MHz, $V_{dd}$ =2.5V
		3.5	4.1		No load, F=20MHz, $V_{dd}$ =1.8V
		6.2	7.5		No load, F=125MHz, $V_{dd}$ =2.8V,3.0V,3.3V or 2.25V-3.63V
		5.5	6.4		No load, F=125MHz, $V_{dd}$ =2.5V
		4.9	5.6		No load, F=125MHz, $V_{dd}$ =1.8V
OE Disable Current ( $I_{OD}$ )			4.2	mA	$V_{dd}$ =2.5V-3.3V, OE=GND, output is in High-Z state
			4.0		$V_{dd}$ =1.8V, OE=GND, output is in High-Z state
Standby Current ( $I_{std}$ )		2.6	4.3	$\mu$ A	$\overline{ST}$ =GND, $V_{dd}$ =2.8V-3.3V, output is weakly pulled down
		1.4	2.5		$\overline{ST}$ =GND, $V_{dd}$ =2.5V, output is weakly pulled down
		0.6	1.3		$\overline{ST}$ =GND, $V_{dd}$ =1.8V, output is weakly pulled down
Startup Time ( $T_{start}$ )			5	ms	Measured from the time $V_{dd}$ reaches its rated minimum value
Enable/Disable Time ( $T_{oe}$ )			130	ns	F=110MHz. For other frequencies, $T_{oe}$ =100ns+3*cycles
			122		F=137MHz. For other frequencies, $T_{oe}$ =100ns+3*cycles
Resume Time ( $T_{resume}$ )			5	ms	Measured from the time $\overline{ST}$ pin crosses 50% threshold



5101 Hidden Creek Ln Spicewood TX 78669  
Phone: 512-371-6159 | Fax: 512-351-8858  
For terms and conditions of sales, please visit:  
www.abracon.com

REVISED: 12.14.2018

ABRACON IS  
ISO9001-2015  
CERTIFIED

# Low power, Programmable SMD MEMS Oscillator



ASTMLP



RoHS/RoHS II compliant

2.0 x 1.6 x 0.75mm; 2.5 x 2.0 x 0.75mm;  
3.2 x 2.5 x 0.75mm; 5.0 x 3.2 x 0.75mm;  
7.0 x 5.0 x 0.9mm

(Continued)

Parameters	Min	Typ	Max	Unit	Notes
Output Type	LVCMOS				
Duty Cycle	45		55	%	All V <sub>dd</sub> options
Rise/Fall Time ( T <sub>r</sub> /T <sub>f</sub> )		1	2	ns	V <sub>dd</sub> =2.5V, 2.8V, 3.0V or 3.3V, 20%-80%
		1.3	2.5		V <sub>dd</sub> =1.8V, 20%-80%
			2		V <sub>dd</sub> =2.25V-3.63V, 20%-80%
Output High Voltage (V <sub>OH</sub> )	90%*V <sub>dd</sub>			V	I <sub>OH</sub> =-4mA (V <sub>dd</sub> =3.0V or 3.3V)
					I <sub>OH</sub> =-3mA (V <sub>dd</sub> =2.8V or 2.5V)
					I <sub>OH</sub> =-2mA (V <sub>dd</sub> =1.8V)
Output Low Voltage (V <sub>OL</sub> )			10%*V <sub>dd</sub>	V	I <sub>OL</sub> =4mA (V <sub>dd</sub> =3.0V or 3.3V)
					I <sub>OL</sub> =3mA (V <sub>dd</sub> =2.8V or 2.5V)
					I <sub>OL</sub> =2mA (V <sub>dd</sub> =1.8V)
Input High Voltage(V <sub>IH</sub> )	70%*V <sub>dd</sub>			V	Pin 1
Input Low Voltage(V <sub>IL</sub> )			30%*V <sub>dd</sub>	V	Pin 1
Input Pull-up Impedance ( Z <sub>in</sub> )	50	87	150	kΩ	Pin 1, OE logic high or logic low, ST logic high
	2			MΩ	Pin 1, ST logic low
RMS Period Jitter ( T <sub>jitt</sub> )		1.8	3	ps	F=75MHz, V <sub>dd</sub> =2.5V, 2.8V, 3.0V or 3.3V
		1.8	3		F=75MHz, V <sub>dd</sub> =1.8V
		1.9	3		F=125MHz, V <sub>dd</sub> =2.5V, 2.8V, 3.0V or 3.3V
		1.8	4		F=125MHz, V <sub>dd</sub> =1.8V
Peak-to-peak Period Jitter (T <sub>pk</sub> )		12	25	ps	F=75MHz, 125MHz, V <sub>dd</sub> =2.5V, 2.8V, 3.0V or 3.3V
		14	30		F=75MHz, 125MHz, V <sub>dd</sub> =1.8V
RMS Phase Jitter (random) ( T <sub>phj</sub> )		0.5	0.9	ps	F=75MHz, integration bandwidth=900kHz to 7.5MHz
		1.3	2		F=75MHz, integration bandwidth=12kHz to 20MHz

## Standard Frequency (MHz)

Standard Frequency (MHz)								
3.57	4	4.096	6	7.3728	8.192	10	12	14
18.432	19.2	20	24	24.576	25	25.000625	26	27
28.6363	30	31.25	32.768	33	33.3	33.33	33.333	33.3333
33.3333	37.5	38	38.4	40	40.5	48	50	54
60	62.5	65	66	66.66	66.66	66.666	66.6666	66.66666
72	74.175824	74.176	74.25	75	77.76			

# Low power, Programmable SMD MEMS Oscillator



2.0 x 1.6 x 0.75mm; 2.5 x 2.0 x 0.75mm;  
3.2 x 2.5 x 0.75mm; 5.0 x 3.2 x 0.75mm;  
7.0 x 5.0 x 0.9mm

ASTMLP

RoHS/RoHS II compliant

## Absolute Maximum Ratings

Attempted operation outside the absolute maximum ratings may cause permanent damage to the part. Actual performance of the IC is only guaranteed within the operational specifications, not at absolute maximum ratings.

Parameters	Min.	Max.	Unit
Storage Temperature	-65	150	°C
V <sub>DD</sub>	-0.5	4	V
Electrostatic Discharge (HBM)		2000	V
Soldering Temperature (follow standard Pb free soldering guidelines)		260	°C
Junction Temperature <sup>(1)</sup>		150	°C

Note: 1. Exceeding this temperature for extended period of time may damage the device

## Thermal Consideration

Package	θ <sub>JA</sub> , 4 Layer Board (°C/W)	θ <sub>JA</sub> , 2 Layer Board (°C/W)	θ <sub>JC</sub> , Bottom (°C/W)
7.0 x 5.0mm	142	273	30
5.0 x 3.2mm	97	199	24
3.2 x 2.5mm	109	212	27
2.5 x 2.0mm	117	222	26
2.0 x 1.6mm	152	252	36

## Maximum Operating Junction Temperature <sup>(2)</sup>

Max. Operating Temperature (ambient)	Max. Operating Junction Temperature
70°C	80°C
85°C	95°C

Note: 2. Datasheet specifications are not guaranteed if junction temperature exceeds the maximum operating junction temperature

## PART IDENTIFICATION:

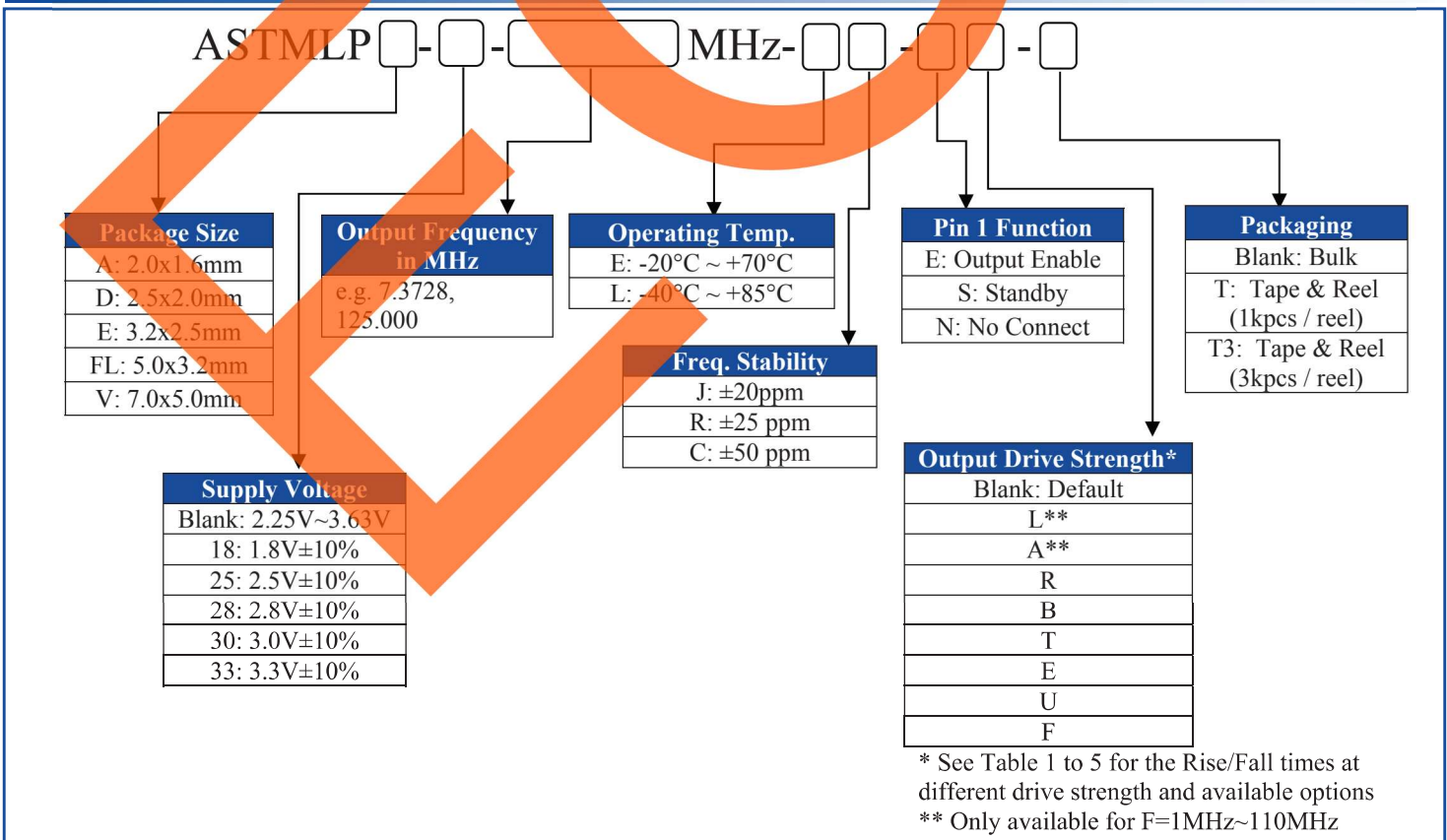



**Table 1:  $V_{dd}=1.8V$  Rise/Fall Times for Specific  $C_{LOAD}$**

**(a) Output Frequency: 1MHz – 110MHz**

Drive Strength Options	Rise/Fall Time Typ. (ns)				
	$C_{LOAD}$				
	5pF	15pF	30pF	45pF	60pF
L	6.16	11.61	22.00	31.27	39.91
A	3.19	6.35	11.00	16.01	21.52
R	2.11	4.31	7.65	10.77	14.47
B	1.65	3.23	5.79	8.18	11.08
T	0.93	1.91	3.32	4.66	6.48
E	0.78	1.66	2.94	4.09	5.74
U	0.70	1.48	2.64	3.68	5.09
F or Blank (default)	0.65	1.30	2.40	3.35	4.56

**(b) Output Frequency: 115MHz – 137MHz**

Drive Strength Options	Rise/Fall Time Typ. (ns)	
	$C_{LOAD}$	
	5pF	15pF
T	0.93	N/A
E	0.78	N/A
U	0.70	1.48
F or Blank (default)	0.65	1.30

**Table 2:  $V_{dd}=2.5V$  Rise/Fall Times for Specific  $C_{LOAD}$**

**(a) Output Frequency: 1MHz – 110MHz**

Drive Strength Options	Rise/Fall Time Typ. (ns)				
	$C_{LOAD}$				
	5pF	15pF	30pF	45pF	60pF
L	4.13	8.25	12.82	21.45	27.79
A	2.11	4.27	7.64	11.20	14.49
R	1.45	2.81	5.16	7.65	9.88
B	1.09	2.20	3.88	5.86	7.57
T	0.62	1.28	2.27	3.51	4.45
E or Blank (default)	0.54	1.00	2.01	3.10	4.01
U	0.43	0.96	1.81	2.79	3.65
F	0.34	0.88	1.64	2.54	3.32

**(b) Output Frequency: 115MHz – 137MHz**

Drive Strength Options	Rise/Fall Time Typ. (ns)	
	$C_{LOAD}$	
	5pF	15pF
R	1.45	N/A
B	1.09	N/A
T	0.62	1.28
E or Blank (default)	0.54	1.00
U	0.43	0.96
F	0.34	0.88

**Table 3:  $V_{dd}=2.8V$  Rise/Fall Times for Specific  $C_{LOAD}$**

**(a) Output Frequency: 1MHz – 110MHz**

Drive Strength Options	Rise/Fall Time Typ. (ns)				
	$C_{LOAD}$				
	5pF	15pF	30pF	45pF	60pF
L	3.77	7.54	12.28	19.57	25.27
A	1.94	3.90	7.03	10.24	13.34
R	1.29	2.57	4.72	7.01	9.06
B	0.97	2.00	3.54	5.43	6.93
T	0.55	1.12	2.08	3.22	4.08
E or Blank (default)	0.44	1.00	1.83	2.82	3.67
U	0.34	0.88	1.64	2.52	3.30
F	0.29	0.81	1.48	2.29	2.99

**(b) Output Frequency: 115MHz – 137MHz**

Drive Strength Options	Rise/Fall Time Typ. (ns)		
	$C_{LOAD}$		
	5pF	15pF	30pF
R	1.29	N/A	N/A
B	0.97	N/A	N/A
T	0.55	1.12	N/A
E or Blank (default)	0.44	1.00	N/A
U	0.34	0.88	N/A
F	0.29	0.81	1.48



2.0 x 1.6 x 0.75mm; 2.5 x 2.0 x 0.75mm;  
3.2 x 2.5 x 0.75mm; 5.0 x 3.2 x 0.75mm;  
7.0 x 5.0 x 0.9mm

ASTMLP



RoHS/RoHS II compliant

**Table 4: V<sub>dd</sub>=3.0V Rise/Fall Times for Specific C<sub>LOAD</sub>**

**(a) Output Frequency: 1MHz – 110MHz**

Drive Strength Options	Rise/Fall Time Typ. (ns)				
	C <sub>LOAD</sub>				
	5pF	15pF	30pF	45pF	60pF
L	3.60	7.21	11.97	18.74	24.30
A	1.84	3.71	6.72	9.86	12.68
R	1.22	2.46	4.54	6.76	8.62
B	0.89	1.92	3.39	5.20	6.64
T or Blank (default)	0.51	1.00	1.97	3.07	3.90
E	0.38	0.92	1.72	2.71	3.51
U	0.30	0.83	1.55	2.40	3.13
F	0.27	0.76	1.39	2.16	2.85

**(b) Output Frequency: 115MHz – 137MHz**

Drive Strength Options	Rise/Fall Time Typ. (ns)		
	C <sub>LOAD</sub>		
	5pF	15pF	30pF
R	1.22	N/A	N/A
B	0.89	N/A	N/A
T or Blank (default)	0.51	1.00	N/A
E	0.38	0.92	N/A
U	0.30	0.83	N/A
F	0.27	0.76	1.39

**Table 5: V<sub>dd</sub>=3.3V Rise/Fall Times for Specific C<sub>LOAD</sub>**

**(a) Output Frequency: 1MHz – 110MHz**

Drive Strength Options	Rise/Fall Time Typ. (ns)				
	C <sub>LOAD</sub>				
	5pF	15pF	30pF	45pF	60pF
L	3.39	6.88	11.63	17.56	23.59
A	1.74	3.50	6.38	8.89	12.19
R	1.16	2.33	4.29	6.04	8.34
B	0.81	1.82	3.22	4.52	6.33
T or Blank (default)	0.46	1.00	1.86	2.60	3.84
E	0.33	0.87	1.64	2.30	3.35
U	0.28	0.79	1.46	2.05	2.93
F	0.25	0.72	1.31	1.83	2.61

**(b) Output Frequency: 115MHz – 137MHz**

Drive Strength Options	Rise/Fall Time Typ. (ns)		
	C <sub>LOAD</sub>		
	5pF	15pF	30pF
R	1.16	N/A	N/A
B	0.81	N/A	N/A
T or Blank (default)	0.46	1.00	N/A
E	0.33	0.87	N/A
U	0.28	0.79	1.46
F	0.25	0.72	1.31

## ➤ CALCULATING MAXIMUM FREQUENCY

Based on the rise and fall time data given in Table 1 through 5, the maximum frequency the oscillator can operate with a guaranteed full swing of the output voltage over temperature is calculated as follows:

$$\text{Max. Frequency} = \frac{1}{5 \times T_{r/f}}$$

Example:

Calculate F<sub>max</sub> of a 1MHz ~ 110MHz device with the following condition:

- V<sub>dd</sub> = 1.8V (Table 1)
- Capacitive Load = 30pF
- Desired T<sub>r/f</sub> Time: = 3ns (rise/fall time option code “E”)

The F<sub>max</sub> is 66.66666MHz.

# Low power, Programmable SMD MEMS Oscillator



ASTMLP



RoHS/RoHS II compliant

2.0 x 1.6 x 0.75mm; 2.5 x 2.0 x 0.75mm;  
3.2 x 2.5 x 0.75mm; 5.0 x 3.2 x 0.75mm;  
7.0 x 5.0 x 0.9mm

## TYPICAL PERFORMANCE DATA

All plots are measured with 15pF load at room temperature, unless otherwise stated.

### I<sub>DD</sub> vs. Frequency

1MHz-110MHz Devices

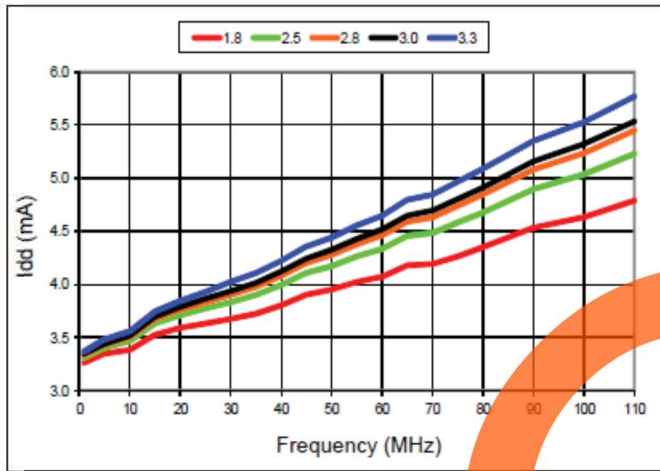

115MHz -137MHz Devices

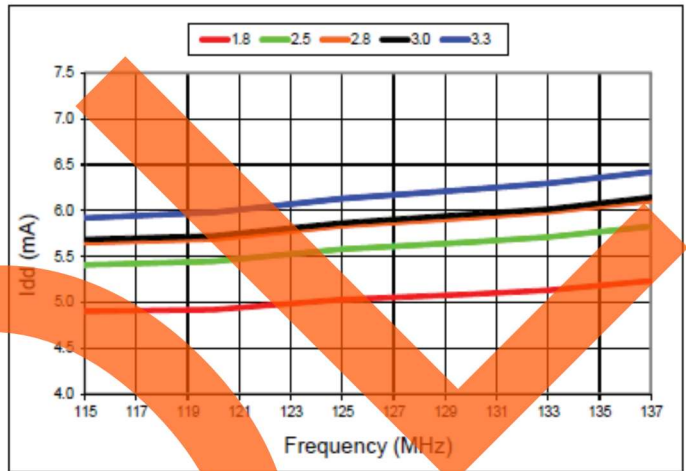

### Frequency vs. Temperature

1MHz-110MHz Devices

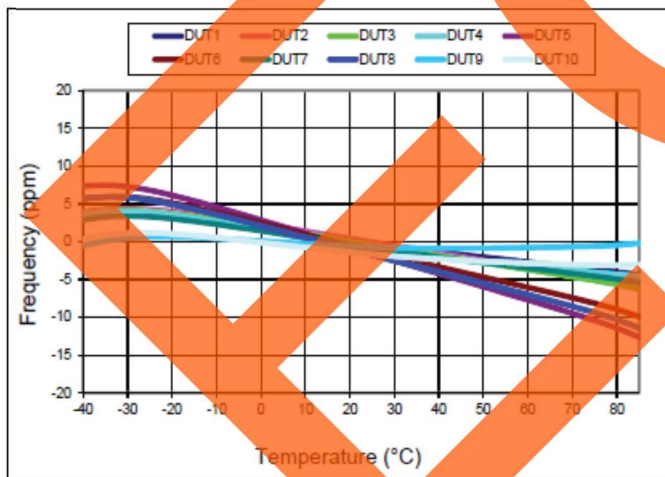

115MHz -137MHz Devices

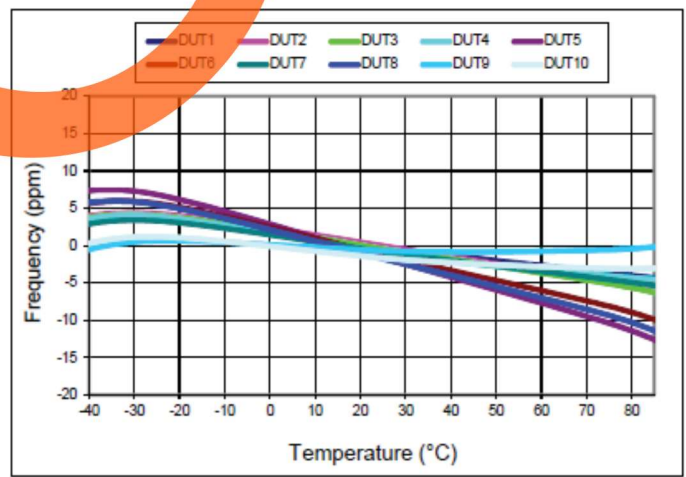



ASTMLP



RoHS/RoHS II compliant

2.0 x 1.6 x 0.75mm; 2.5 x 2.0 x 0.75mm;  
3.2 x 2.5 x 0.75mm; 5.0 x 3.2 x 0.75mm;  
7.0 x 5.0 x 0.9mm

## TYPICAL PERFORMANCE DATA

### RMS Period Jitter vs. Frequency

1MHz-110MHz Devices

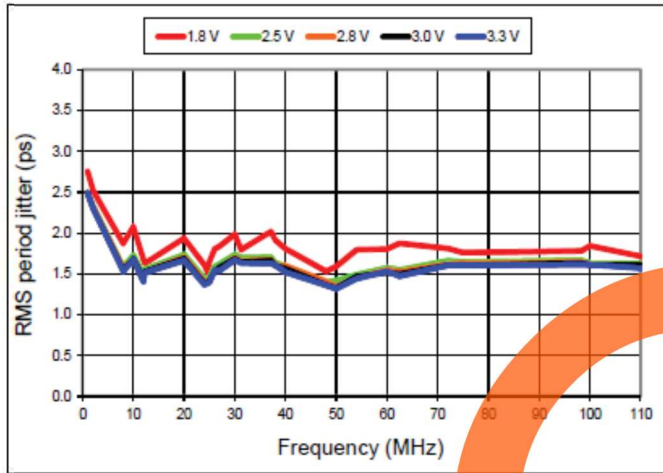

115MHz -137MHz Devices

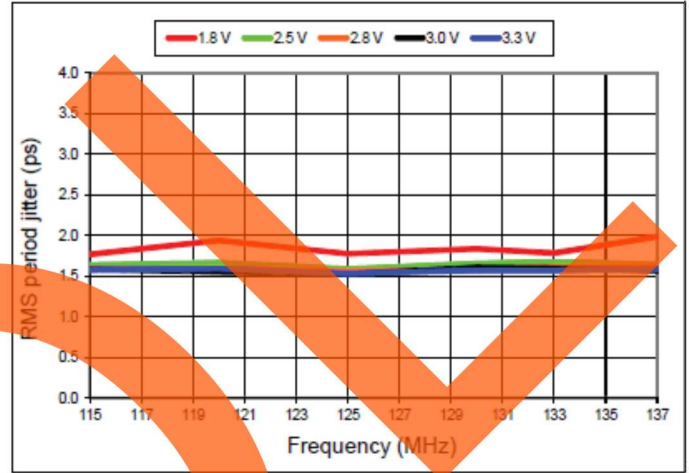

### Duty Cycle vs. Frequency

1MHz-110MHz Devices

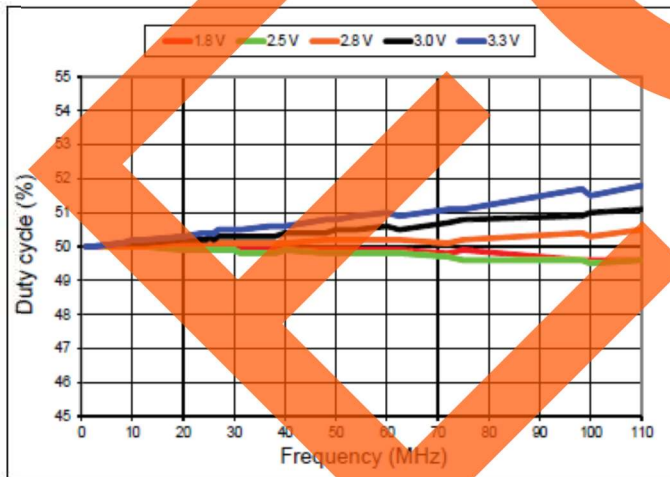

115MHz -137MHz Devices

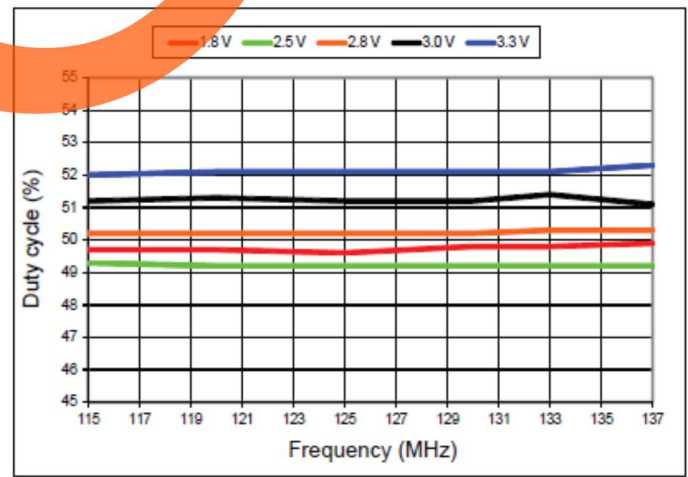



# Low power, Programmable SMD MEMS Oscillator



ASTMLP



RoHS/RoHS II compliant

2.0 x 1.6 x 0.75mm; 2.5 x 2.0 x 0.75mm;  
3.2 x 2.5 x 0.75mm; 5.0 x 3.2 x 0.75mm;  
7.0 x 5.0 x 0.9mm

## TYPICAL PERFORMANCE DATA

### 20% - 80% Rise Time vs. Temperature

1MHz-110MHz Devices

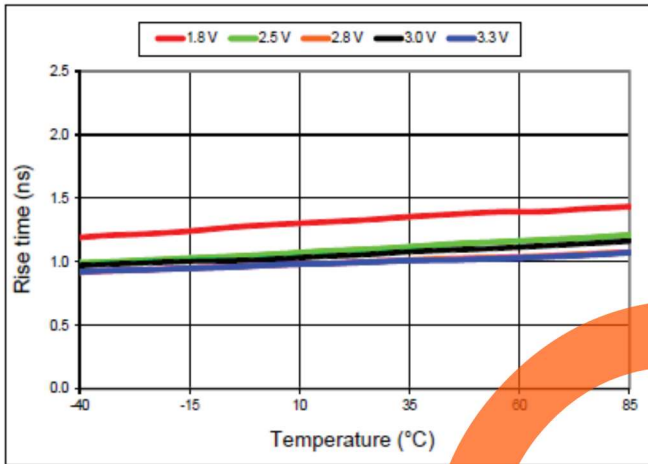

115MHz -137MHz Devices

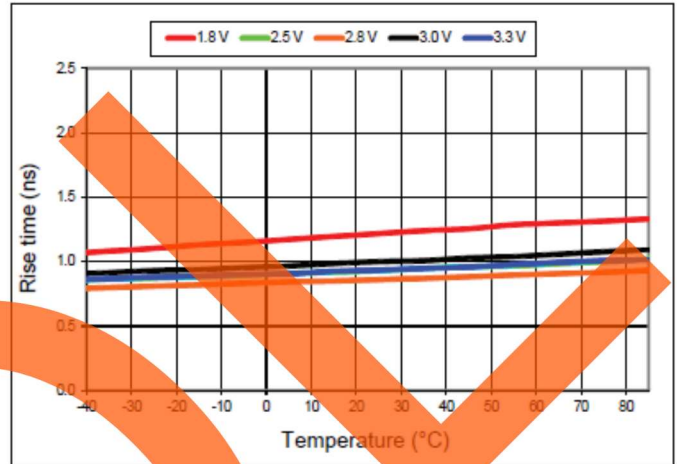

### 20% - 80% Fall Time vs. Temperature

1MHz-110MHz Devices

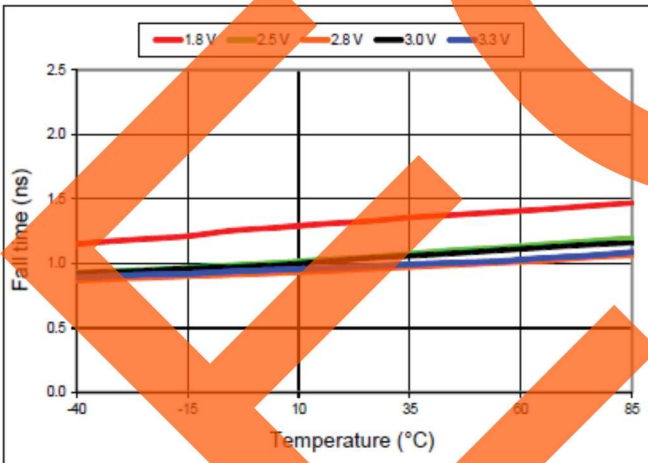

115MHz -137MHz Devices

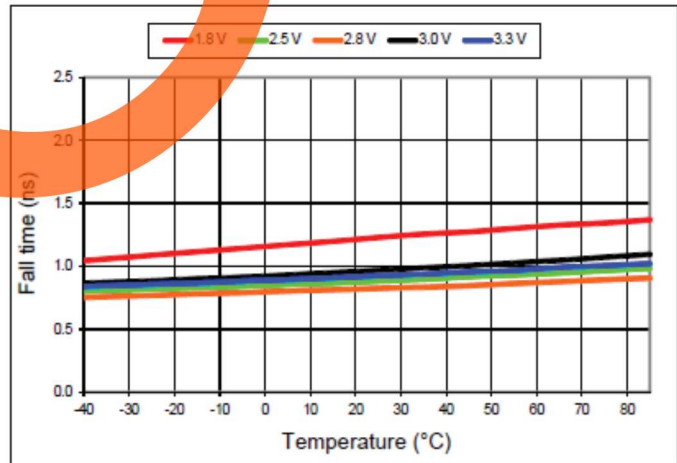



2.0 x 1.6 x 0.75mm; 2.5 x 2.0 x 0.75mm;  
3.2 x 2.5 x 0.75mm; 5.0 x 3.2 x 0.75mm;  
7.0 x 5.0 x 0.9mm

ASTMLP



RoHS/RoHS II compliant

## TYPICAL PERFORMANCE DATA

### RMS Integrated Phase Jitter Random (12kHz to 20MHz) vs Frequency <sup>(3)</sup>

1MHz-110MHz Devices

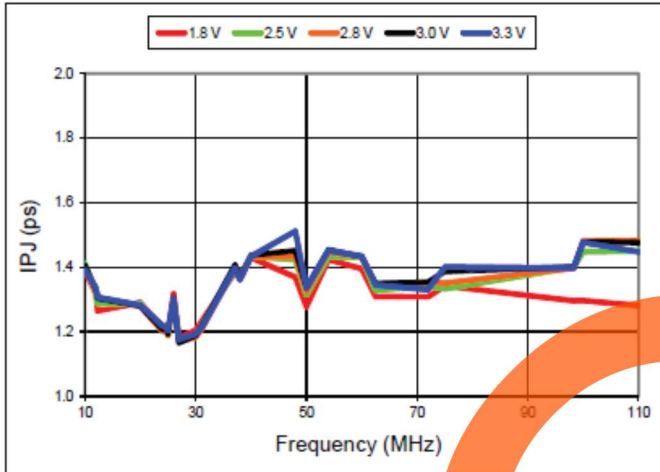

115MHz -137MHz Devices

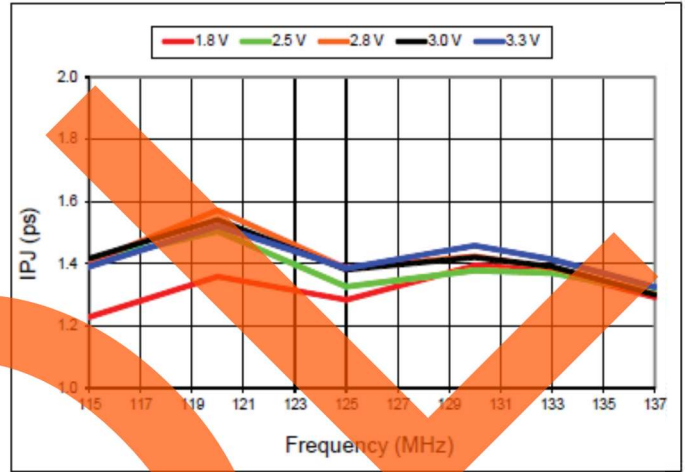

### RMS Integrated Phase Jitter Random (900kHz to 20MHz) vs Frequency <sup>(3)</sup>

1MHz-110MHz Devices

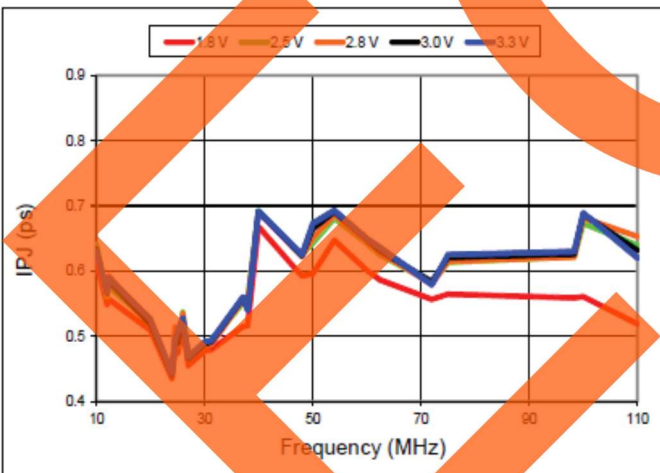

115MHz -137MHz Devices

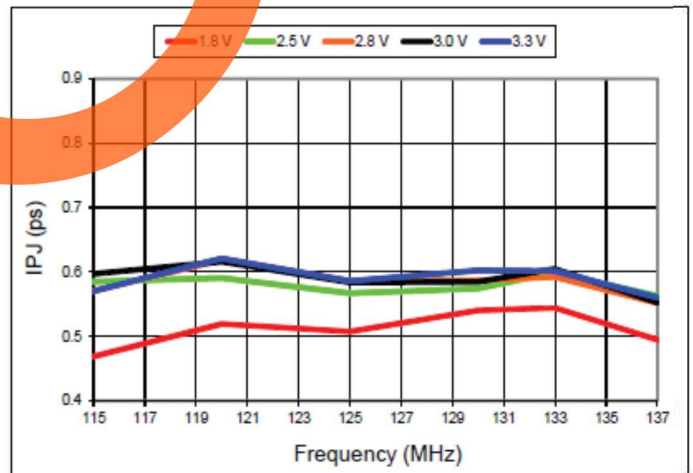

Notes: 3. Phase noise plots are measured with Agilent E5052B signal source analyzer. Integration range is up to 5MHz for carrier frequencies below 40MHz.

# Low power, Programmable SMD MEMS Oscillator

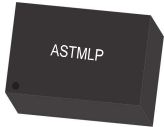

ASTMLP



RoHS/RoHS II compliant

2.0 x 1.6 x 0.75mm; 2.5 x 2.0 x 0.75mm;  
3.2 x 2.5 x 0.75mm; 5.0 x 3.2 x 0.75mm;  
7.0 x 5.0 x 0.9mm

## OUTLINE DIMENSION:

### 2.0 x 1.6mm Package (Option "A")

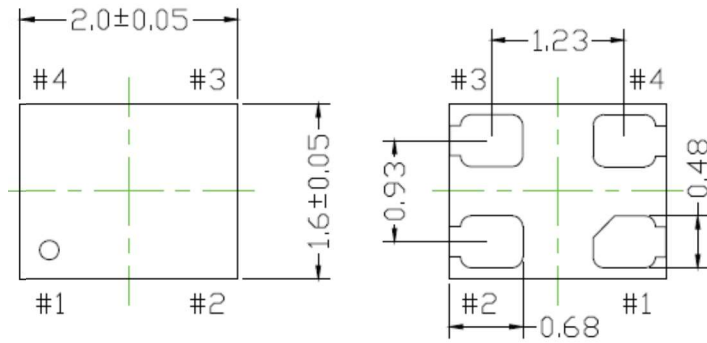

### Recommended Land Pattern

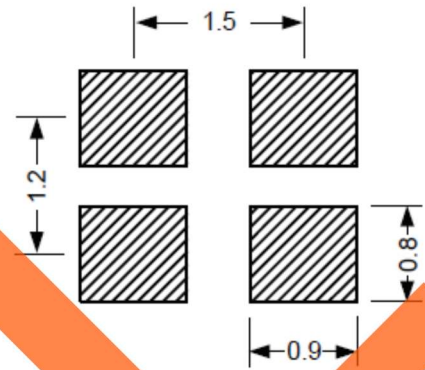

### 2.5 x 2.0mm Package (Option "D")

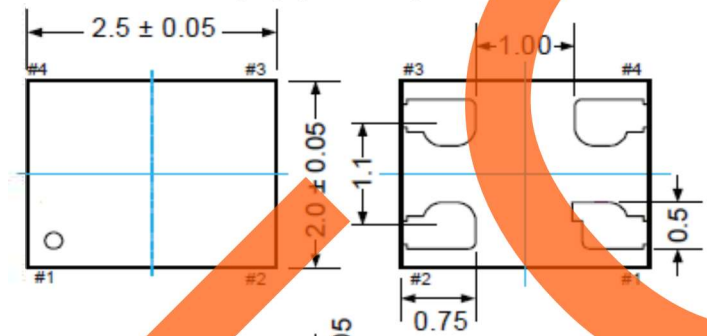

### Recommended Land Pattern

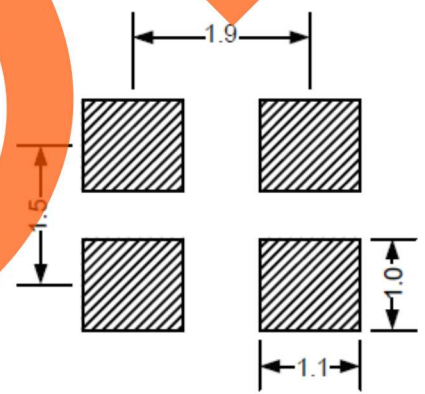

### 3.2 x 2.5mm Package (Option "E")

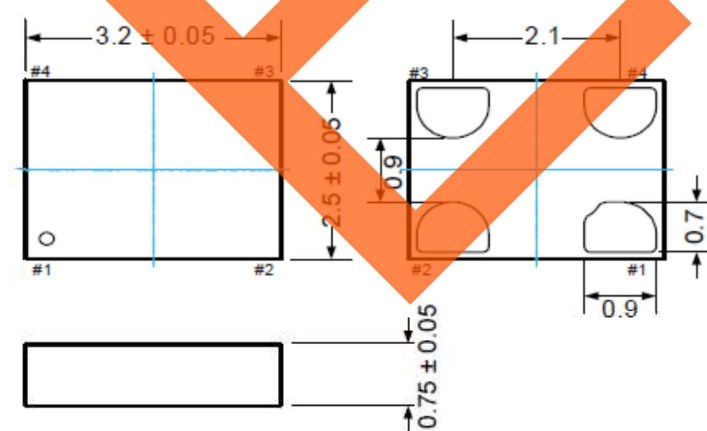

### Recommended Land Pattern

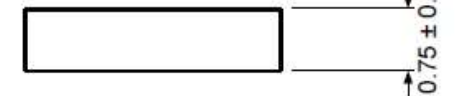
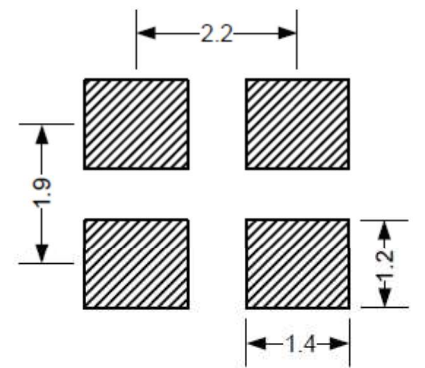

# Low power, Programmable SMD MEMS Oscillator



ASTMLP

RoHS/RoHS II compliant

2.0 x 1.6 x 0.75mm; 2.5 x 2.0 x 0.75mm;  
3.2 x 2.5 x 0.75mm; 5.0 x 3.2 x 0.75mm;  
7.0 x 5.0 x 0.9mm

## OUTLINE DIMENSION:

### 5.0 x 3.2mm Package (Option "FL")

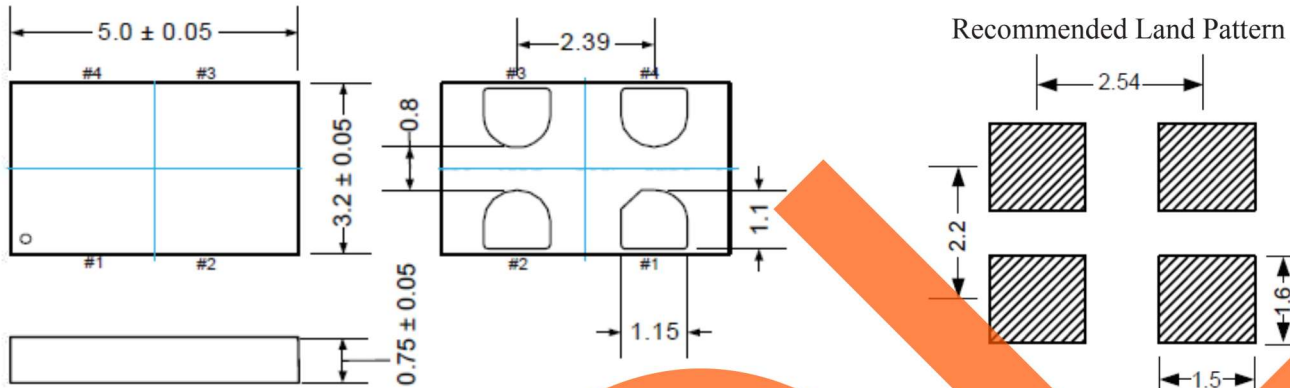

### 7.0 x 5.0mm Package (Option "V")

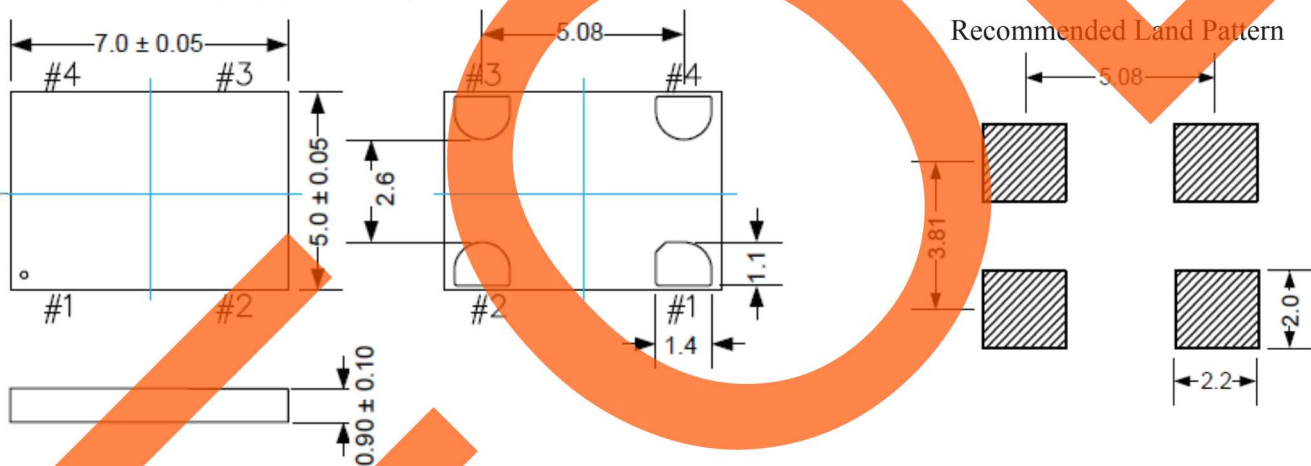

Pin	Name	Functionality
1	Output Enable	H or Open <sup>(4)</sup> : specified frequency output L: output is high impedance. Only output driver is disabled
	Standby	H or Open <sup>(4)</sup> : specified frequency output L: output is low (weak pull down). Device goes to sleep mode. Supply current reduces to I <sub>std</sub> .
	No Connect	Any voltage between 0 and V <sub>dd</sub> or Open <sup>(4)</sup> : specified frequency output. Pin 1 has no function.
2	GND	Power Electrical ground <sup>(5)</sup>
3	Out	Output Oscillator clock output
4	V <sub>dd</sub>	Power Power supply voltage <sup>(5)</sup>

Notes: 4. In OE or  $\overline{ST}$  mode, a pull-up resistor of  $<10k\Omega$  between OE/ $\overline{ST}$  pin and V<sub>dd</sub> is recommended if pin 1 is not externally driven. If pin 1 needs to be left floating, use the NC option.  
5. A capacitor value of 0.1 $\mu$ F between V<sub>dd</sub> and GND is required.

Dimensions: mm

# Low power, Programmable SMD MEMS Oscillator



ASTMLP



RoHS/RoHS II compliant

2.0 x 1.6 x 0.75mm; 2.5 x 2.0 x 0.75mm;  
3.2 x 2.5 x 0.75mm; 5.0 x 3.2 x 0.75mm;  
7.0 x 5.0 x 0.9mm

## REFLOW PROFILE:

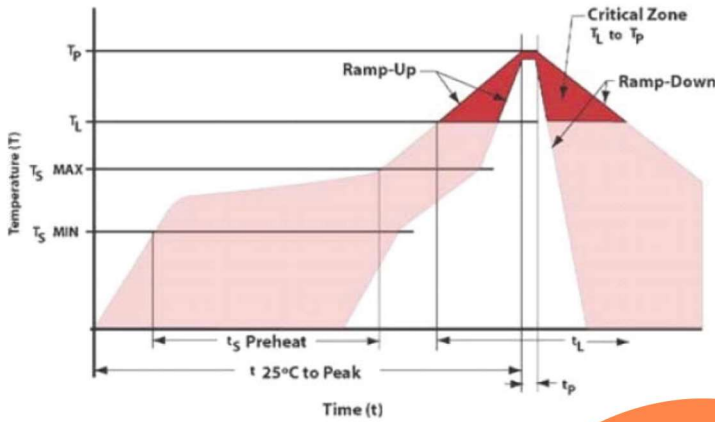

Item	Conditions
T <sub>S</sub> MAX to T <sub>L</sub> (Ramp-up Rate)	3°C/second max
Preheat	
Temperature Minimum (T <sub>S</sub> MIN)	150°C
Temperature Typical (T <sub>S</sub> TYP)	175°C
Temperature Maximum (T <sub>S</sub> MAX)	200°C
Time (t <sub>s</sub> )	60 – 180 seconds
Ramp-up Rate (T <sub>L</sub> to T <sub>P</sub> )	3°C/second max
Time Maintained Above	
Temperature (T <sub>L</sub> )	217°C
Time (t <sub>L</sub> )	60 – 150 seconds
Peak Temperature (T <sub>P</sub> )	260°C max
Target Peak Temperature (T <sub>P</sub> Target)	255°C
Time within 5°C of actual peak (t <sub>P</sub> )	20 – 40 seconds
Max. Number of Reflow Cycles	3
Ramp-down Rate	6°C/second max
Time 25°C to Peak Temperature (t)	8 minutes max

## TAPE & REEL:

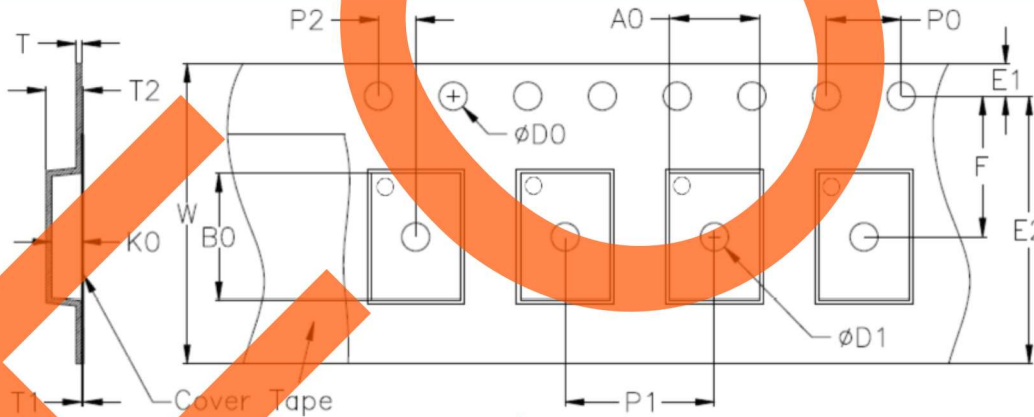

Device Size	D0	D1 min.	E1	E2 min.	F	P0	P1	P2
2016	1.55±0.05	0.9	1.75±0.1	6.05	3.5±0.05	4.0±0.1	4.0±0.1	2.0±0.05
2520	1.55±0.05	1.0	1.75±0.1	5.85	3.5±0.05	4.0±0.1	4.0±0.1	2.0±0.05
3225	1.5+0.1/-0.0	1.0	1.75±0.1	5.95	3.5±0.05	4.0±0.1	4.0±0.1	2.0±0.05
5032	1.5+0.1/-0.0	1.5	1.75±0.1	10.25	5.5±0.05	4.0±0.1	8.0±0.1	2.0±0.05
7050	1.5+0.1/-0.0	1.5	1.75±0.1	14.25	7.5±0.1	4.0±0.1	8.0±0.1	2.0±0.1

Device Size	T	T1 max.	T2 max.	W max.	A0	B0	K0
2016	0.3±0.05	0.1	1.55	8.3	1.9±0.05	2.3±0.05	1.00±0.10
2520	0.3±0.05	0.1	1.65	8.3	2.25±0.05	2.8±0.05	1.10±0.10
3225	0.2±0.05	0.1	1.6	8.2	2.7±0.10	3.4±0.10	1.15±0.10
5032	0.6	0.1	1.65	12.3	3.5±0.10	5.3±0.10	1.10±0.10
7050	0.6	0.1	1.80	16.3	5.4±0.10	7.4±0.10	1.3±0.10

Unit: mm



5101 Hidden Creek Ln Spicewood TX 78669  
Phone: 512-371-6159 | Fax: 512-351-8858  
For terms and conditions of sales, please visit:  
www.abracon.com

REVISED: 12.14.2018

ABRACON IS  
ISO9001-2015  
CERTIFIED

# Low power, Programmable SMD MEMS Oscillator



ASTMLP



RoHS/RoHS II compliant

2.0 x 1.6 x 0.75mm; 2.5 x 2.0 x 0.75mm;  
3.2 x 2.5 x 0.75mm; 5.0 x 3.2 x 0.75mm;  
7.0 x 5.0 x 0.9mm

## TAPE & REEL:

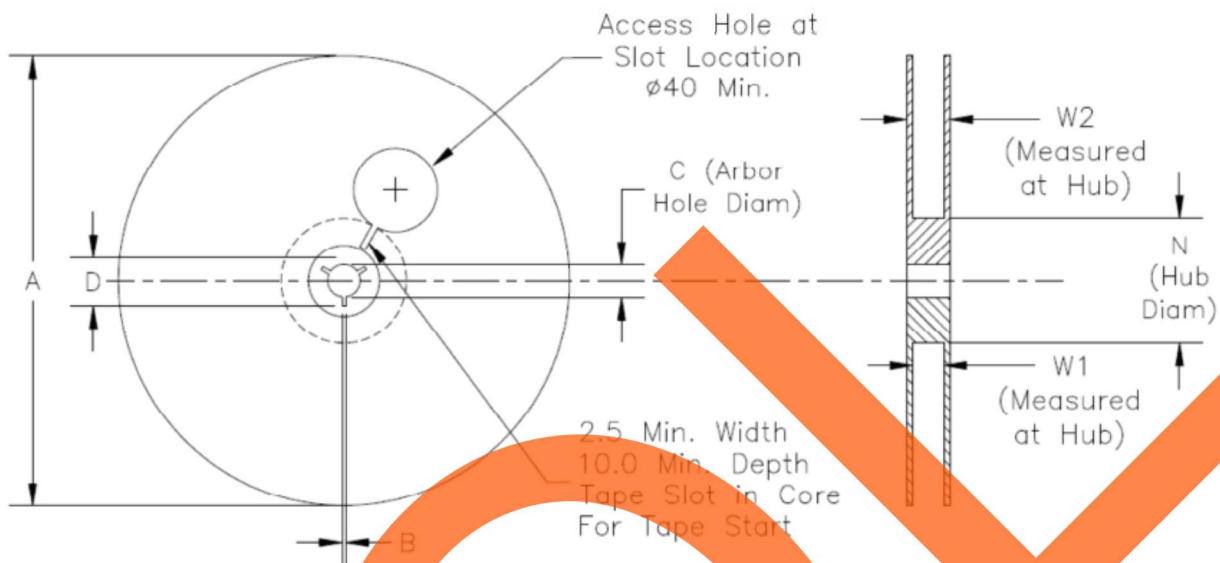

Unit: mm

Tape Size	A max.	B min.	C	D min.	N	W1	W2 max.
8mm	180	1.5	13.0+0.6/-0.2	20.2	60±0.5	8.4+1.5/-0	14.4
12mm	180	1.5	13.0±0.2	20.2	60±0.5	12.4+2.0/-0	18.4
	330	1.5	13.0±0.2	20.2	100±0.5	12.4+2.0/-0	18.4
16mm	180	1.5	13.0±0.2	20.2	60±0.5	16.4+2.0/-0	22.4
	330	1.5	13.0±0.2	20.2	100±0.5	16.4+2.0/-0	22.4

Device Size	"T" (1k/reel)		"T3" (3k/reel)	
2016	8mm Tape	7" Reel	8mm Tape	7" Reel
2520	8mm Tape	7" Reel	8mm Tape	7" Reel
3225	8mm Tape	7" Reel	8mm Tape	7" Reel
5032	12mm Tape	7" Reel	12mm Tape	13" Reel
7050	16mm Tape	7" Reel	16mm Tape	13" Reel

**ATTENTION:** Abracon LLC's products are COTS – Commercial-Off-The-Shelf products; suitable for Commercial, Industrial and, where designated, Automotive Applications. Abracon's products are not specifically designed for Military, Aviation, Aerospace, Life-dependent Medical applications or any application requiring high reliability where component failure could result in loss of life and/or property. For applications requiring high reliability and/or presenting an extreme operating environment, written consent and authorization from Abracon LLC is required. Please contact Abracon LLC for more information.



5101 Hidden Creek Ln Spicewood TX 78669  
Phone: 512-371-6159 | Fax: 512-351-8858  
For terms and conditions of sales, please visit:  
www.abracon.com

REVISED: 12.14.2018

ABRACON IS  
ISO9001-2015  
CERTIFIED