

**Data sheet | Item number: 250-1406**

PCB terminal block; push-button; 0.5 mm<sup>2</sup>; Pin spacing 2.54 mm; 6-pole;  
Push-in CAGE CLAMP®; 0,50 mm<sup>2</sup>; gray

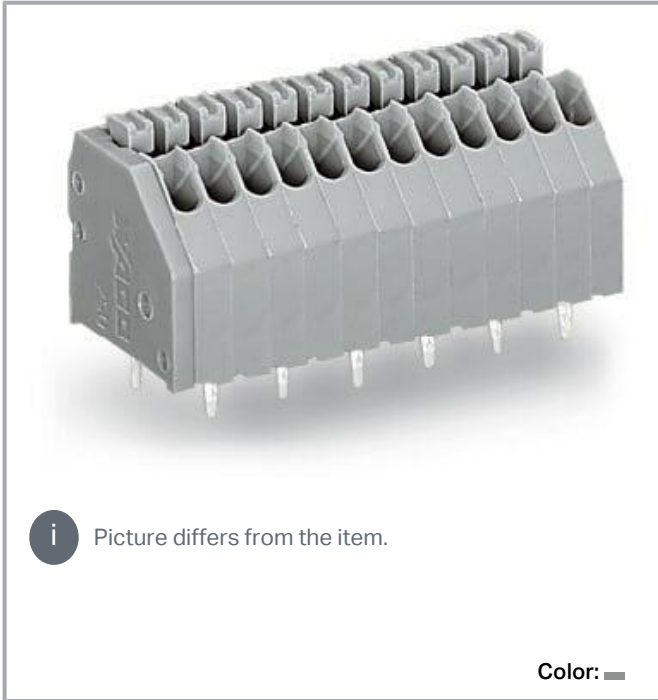

[www.wago.com/250-1406](http://www.wago.com/250-1406)



**i** Picture differs from the item.

Color:

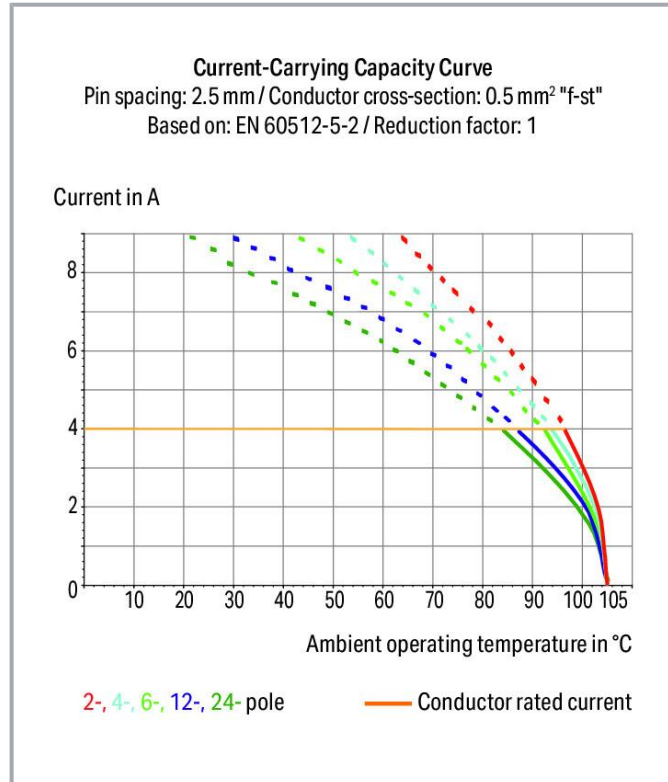

Subject to changes. Please also observe the further product documentation!

WAGO GmbH & Co. KG  
Hansastr. 27  
32423 Minden  
Phone: +49571 887-0 | Fax: +49571 887-169  
Email: [info.de@wago.com](mailto:info.de@wago.com) | Web: [www.wago.com](http://www.wago.com)

Do you have any questions about our products?  
We are always happy to take your call at +49 (571) 887-44222.

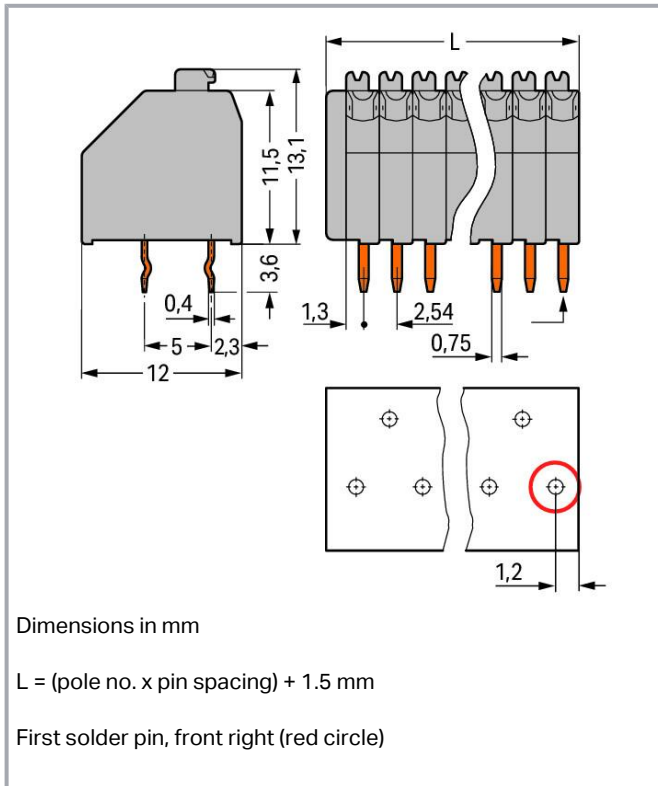

## Item description

- Compact PCB terminal strips with push-buttons
- Push-in termination of solid conductors
- Termination/removal of fine-stranded conductors via push-buttons
- 45° conductor entry angle provides easy, space-saving wiring
- Custom color combinations
- Terminal strips also available with spacers upon request

## Data

### Notes

Variants:

Other pole numbers

Other colors

Mixed-color PCB connector strips

Terminal strips with spacers

Direct marking

Other versions (or variants) can be requested from WAGO Sales or configured at <https://configurator.wago.com/>.

Subject to changes. Please also observe the further product documentation!

WAGO GmbH & Co. KG

Hansastr. 27

32423 Minden

Phone: +49571 887-0 | Fax: +49571 887-169

Email: [info.de@wago.com](mailto:info.de@wago.com) | Web: [www.wago.com](http://www.wago.com)

Do you have any questions about our products?

We are always happy to take your call at +49 (571) 887-44222.

## Electrical data

### Ratings per IEC/EN

Ratings per	IEC/EN 60664-1
Nominal voltage (III/3)	160 V
Rated impulse voltage (III/3)	2.5 kV
Rated voltage (III/2)	160 V
Rated impulse voltage (III/2)	2.5 kV
Nominal voltage (II/2)	320 V
Rated surge voltage (II/2)	2.5 kV
Rated current	4 A
Legend (ratings)	(III / 2) $\triangleq$ Overvoltage category III / Pollution degree 2

### Ratings per UL 1059

Approvals per	UL 1059
Rated voltage UL (Use Group B)	300 V
Rated current UL (Use Group B)	5 A
Rated voltage UL (Use Group D)	300 V
Rated current UL (Use Group D)	5 A

### Ratings per CSA

Approvals per	CSA
Rated voltage CSA (Use Group B)	300 V
Rated current CSA (Use Group B)	5 A
Rated voltage CSA (Use Group D)	300 V
Rated current CSA (Use Group D)	5 A

## Connection data

Connection points	6
Total number of potentials	6
Number of connection types	1
Number of levels	1

## Connection 1

Connection technology	Push-in CAGE CLAMP®
Actuation type	Push-button

Subject to changes. Please also observe the further product documentation!



Solid conductor	0.14 ... 0.5 mm <sup>2</sup> / 24 ... 20 AWG
Fine-stranded conductor	0.2 ... 0.5 mm <sup>2</sup> / 24 ... 20 AWG
Conductor diameter	0.4 ... 0.8 mm / 24 ... 20 AWG
Strip length	8.5 ... 9.5 mm / 0.33 ... 0.37 inches
Conductor connection direction to PCB	45 °
Pole number	6

### Physical data

Pin spacing	2.54 mm / 0.1 inches
Width	16.74 mm / 0.659 inches
Height	16.7 mm / 0.657 inches
Height from the surface	13.1 mm / 0.516 inches
Depth	12 mm / 0.472 inches
Solder pin length	3.6 mm
Solder pin dimensions	0.4 x 0.75 mm
Drilled hole diameter with tolerance	1.1 <sup>(+0.1)</sup> mm

### Plug-in connection

Plugging without loss of pin spacing	No
--------------------------------------	----

### PCB contact

PCB contact	THT
Solder pin arrangement	over the entire terminal strip (staggered)
Number of solder pins per potential	1

### Material Data

Note (material data)	Information on material specifications can be found here
Color	gray
Material group	I
Insulation material	Polyamide (PA66)
Flammability class per UL94	V0
Clamping spring material	Copper alloy
Contact plating	Tin
Fire load	0.048 MJ
Weight	2.3 g

Subject to changes. Please also observe the further product documentation!

## Environmental requirements

Limit temperature range	-60 ... +105 °C
-------------------------	-----------------

## Commercial data





Product Group	4 (Printed Circuit Connectors)
eCl@ss 10.0	27-44-04-01
eCl@ss 9.0	27-44-04-01
ETIM 8.0	EC002643
ETIM 7.0	EC002643
PU (SPU)	280 (70) pcs
Packaging type	box
Country of origin	CH
GTIN	4044918643245
Customs tariff number	85369010000

## Environmental Product Compliance



RoHS Compliance Status	Compliant, No Exemption
------------------------	-------------------------

## Approvals / Certificates



### General approvals

Logo	Approval	Additional Approval Text	Certificate name
	CCA DEKRA Certification B.V.	EN 60947	NTR NL-7833/2
	CCA DEKRA Certification B.V.	EN 60998	NTR NL-7705/1
	CSA DEKRA Certification B.V.	C22.2	1132097
	KEMA/KEUR DEKRA Certification B.V.	EN 60947	2160584.18



Subject to changes. Please also observe the further product documentation!

	<b>KEMA/KEUR</b> DEKRA Certification B.V.	EN 60998	71-124629
	<b>UL</b> UL International Germany GmbH	UL 1059	E45172

#### Declarations of conformity and manufacturer's declarations

Logo	Approval	Additional Approval Text	Certificate name
	<b>EU-Declaration of Conformity</b> WAGO GmbH & Co. KG	-	-
	<b>UK-Declaration of Conformity</b> WAGO GmbH & Co. KG	-	-

#### Approvals for marine applications

Logo	Approval	Additional Approval Text	Certificate name
	<b>ABS</b> American Bureau of Shipping	-	19- HG1869876- PDA
	<b>DNV GL</b> Det Norske Veritas, Germanischer Lloyd	-	TAE000016Z

#### Optional accessories

##### Testing and measuring

###### Testing accessories

	<b>Item no.: 735-500</b> WAGO Test pin; 1 mm Ø; 30 V AC / 60 V DC; CAT0; 1 A; 6 mm uninsulated; Test lead for soldering up to <a href="http://www.wago.com/735-500">www.wago.com/735-500</a> 0,5mm <sup>2</sup>
--	---







##### Marking accessories

###### Marking strip

Subject to changes. Please also observe the further product documentation!

WAGO GmbH & Co. KG  
 Hansastr. 27  
 32423 Minden  
 Phone: +49571 887-0 | Fax: +49571 887-169  
 Email: [info.de@wago.com](mailto:info.de@wago.com) | Web: [www.wago.com](http://www.wago.com)

Do you have any questions about our products?  
 We are always happy to take your call at +49 (571) 887-44222.

	<b>Item no.: 210-331/254-204</b> Marking strips; as a DIN A4 sheet; MARKED; 17-32 (400x); Height of marker strip: 2.3 mm/0.091 in; Strip length 182 mm; Horizontal marking; Self-adhesive; white	<a href="http://www.wago.com/210-331/254-204">www.wago.com/210-331/254-204</a>
	<b>Item no.: 210-331/254-206</b> Marking strips; as a DIN A4 sheet; MARKED; 33-48 (400x); Height of marker strip: 2.3 mm/0.091 in; Strip length 182 mm; Horizontal marking; Self-adhesive; white	<a href="http://www.wago.com/210-331/254-206">www.wago.com/210-331/254-206</a>
	<b>Item no.: 210-331/254-202</b> Marking strips; as a DIN A4 sheet; MARKED; 1-16 (400x); Height of marker strip: 2.3 mm/0.091 in; Strip length 182 mm; Horizontal marking; Self-adhesive; white	<a href="http://www.wago.com/210-331/254-202">www.wago.com/210-331/254-202</a>
	<b>Item no.: 210-331/254-207</b> Marking strips; as a DIN A4 sheet; MARKED; 1-48 (100x); Height of marker strip: 2.3 mm/0.091 in; Strip length 182 mm; Horizontal marking; Self-adhesive; white	<a href="http://www.wago.com/210-331/254-207">www.wago.com/210-331/254-207</a>
<b>Tool</b>		
Operating tool		
	<b>Item no.: 210-647</b> Operating tool; Blade: 2.5 x 0.4 mm; with a partially insulated shaft; multicoloured	<a href="http://www.wago.com/210-647">www.wago.com/210-647</a>
	<b>Item no.: 210-719</b> Operating tool; Blade: 2.5 x 0.4 mm; with a partially insulated shaft	<a href="http://www.wago.com/210-719">www.wago.com/210-719</a>

## Downloads

### Documentation

#### Additional Information

Technical Section	2019 Apr 3	pdf	Download
Technical explanations		2.0 MB	

## CAD/CAE-Data

### CAD data

2D/3D Models 250-1406	URL	Download
-----------------------	-----	----------

### CAE data

EPLAN Data Portal 250-1406	URL	Download
----------------------------	-----	----------

ZUKEN Portal 250-1406	URL	Download
-----------------------	-----	----------

## PCB Design

Subject to changes. Please also observe the further product documentation!

WAGO GmbH & Co. KG  
 Hansastr. 27  
 32423 Minden  
 Phone: +49571 887-0 | Fax: +49571 887-169  
 Email: [info.de@wago.com](mailto:info.de@wago.com) | Web: [www.wago.com](http://www.wago.com)

Do you have any questions about our products?  
 We are always happy to take your call at +49 (571) 887-44222.



[URL](#)

[Download](#)

### Symbol and Footprint 250-1406

CAX data for your PCB design, consisting of "schematic symbols and PCB footprints", allow easy integration of the WAGO component into your development environment.

### Supported formats:

- Accel EDA 14 & 15
- Altium 6 to current version
- Cadence Allegro
- DesignSpark
- Eagle Libraries
- KiCad
- Mentor Graphics BoardStation
- Mentor Graphics Design Architect
- Mentor Graphics Design Expedition 99 and 2000
- OrCAD 9.X PCB and Capture
- PADS PowerPCB 3, 3.5, 4.X, and 5.X
- PADS PowerPCB and PowerLogic 3.0
- PCAD 2000, 2001, 2002, 2004, and 2006
- Pulsonix 8.5 or newer
- STL
- 3D STEP
- TARGET 3001!
- View Logic ViewDraw
- Quadcept
- Zuken CadStar 3 and 4
- Zuken CR-5000 and CR-8000

PCB Component Libraries (EDA), PCB CAD Library Ultra Librarian

---

## Environmental Product Compliance

### Compliance Search

Environmental Product Compliance 250-1406

[URL](#)

[Download](#)

PCB terminal block; push-button; 0.5 mm<sup>2</sup>; Pin spacing 2.54 mm; 6-pole; Push-in CAGE CLAMP®; 0,50 mm<sup>2</sup>; gray

---

Subject to changes. Please also observe the further product documentation!

---

WAGO GmbH & Co. KG

Hansastr. 27

32423 Minden

Phone: +49571 887-0 | Fax: +49571 887-169

Email: [info.de@wago.com](mailto:info.de@wago.com) | Web: [www.wago.com](http://www.wago.com)

Do you have any questions about our products?

We are always happy to take your call at +49 (571) 887-44222.



## Installation Notes

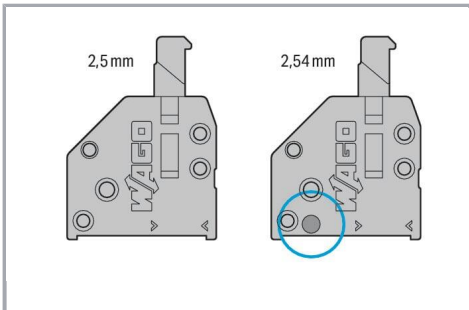

A groove at the back of the terminal strip differentiates between the two pin spacings.

## Conductor termination

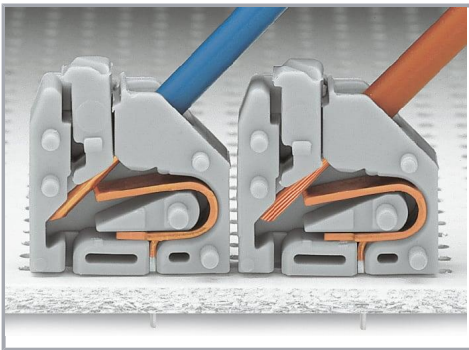

Inserting solid conductors via push-in termination.

Inserting fine-stranded conductors via push-buttons, 250 Series – 3.5 mm pin spacing.

## Conductor termination

Subject to changes. Please also observe the further product documentation!

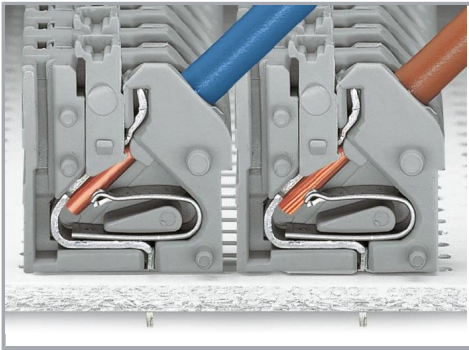

Space-saving wiring, 250 Series – 5 mm pin spacing.

### Testing

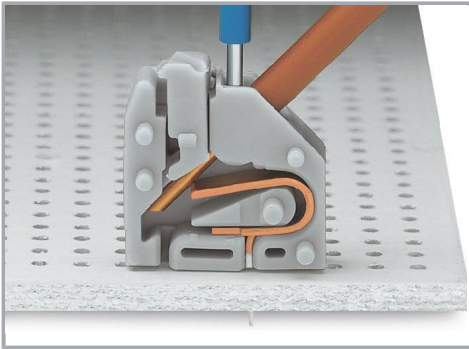

Testing with 11 mm Ø test pin, on the conductor, 250 Series – 2.5 ... 3.5 mm pin spacing.

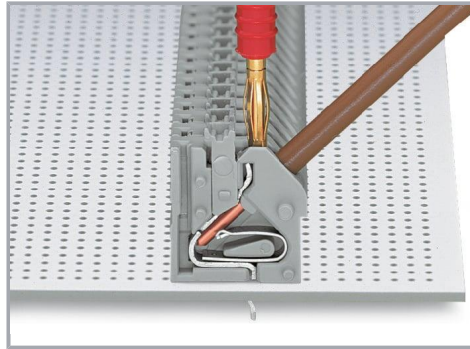

Testing with 2 mm Ø test plug, touch contact, 250 Series – 5 mm pin spacing.

### Marking

Subject to changes. Please also observe the further product documentation!

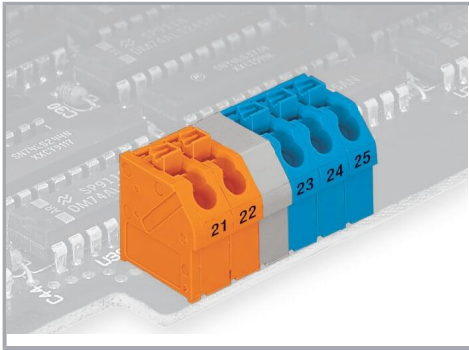

Labeling via self-adhesive strips or direct marking. Mixed-color terminal strips (with or without spacer) are available upon request.



Labeling via self-adhesive strips or direct marking. Mixed-color terminal strips (with or without spacer) are available upon request.

Subject to changes. Please also observe the further product documentation!