

Data sheet | Item number: 890-112

Plug; with strain relief housing; 2-pole; 1,50 mm²; black

www.wago.com/890-112

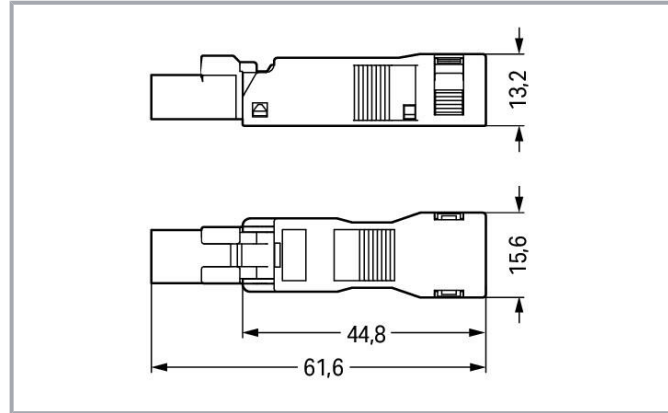
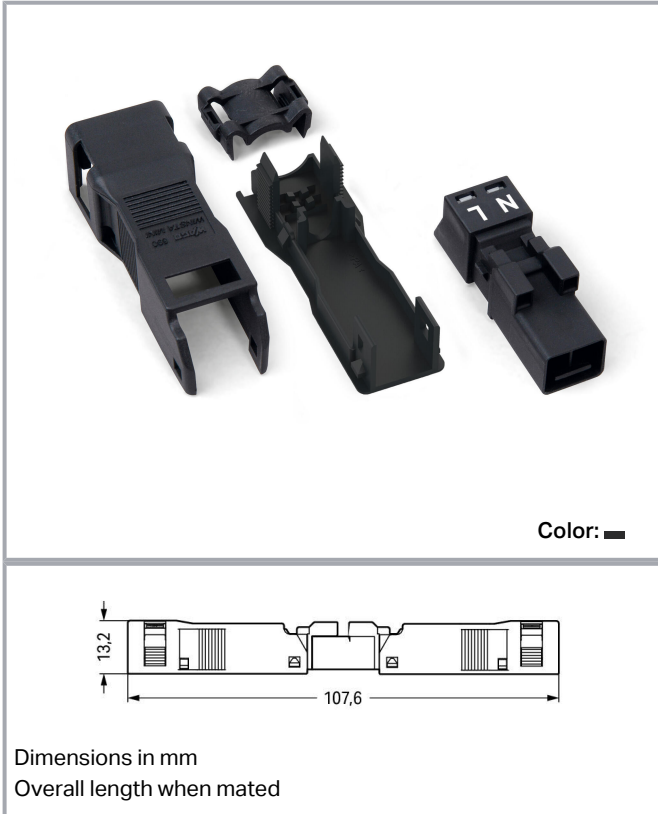

Item description

Male connector/plug *WINSTA*® MINI rated current 16 A

The *WINSTA*® MINI male connector/plug with protection against mismatching allows installation of fine-stranded and solid conductors. Whether on PCBs, in control cabinets or for connecting lights – pluggable installation connectors from WAGO allow you to establish connections according to many different requirements in no time flat. For greater protection in electrical installations, the pluggable installation connector is equipped with mechanical protection against mismatching. The pluggable installation connector is protected against ingress by solid granular objects with a diameter of less than 1 mm in accordance with protection type IP40. Thanks to the color coding and mechanical A coding of *WINSTA*® MINI pluggable installation connectors, you can clearly distinguish different circuits. Especially where space is tight, our smallest pluggable connection system, *WINSTA*® MINI, consistently displays its advantages. It is very compact, and, thanks to Push-in CAGE CLAMP® spring pressure connection technology, it also saves time, since the connection is low-maintenance and can be performed without screw connections. The strip length is 32 mm.

Subject to changes. Please also observe the further product documentation!

WAGO GmbH & Co. KG
Hansastr. 27
32423 Minden
Phone: +49571 887-0 | Fax: +49571 887-169
Email: info.de@wago.com | Web: www.wago.com

Do you have any questions about our products?
We are always happy to take your call at +49 (571) 887-44222.



Lower costs through fast commissioning and elimination of service expenses – solutions from WINSTA® MINI

The WINSTA® Pluggable Connection System allows pluggable electrical installation. This significantly reduces the need for servicing and lowers costs. Choose durability and quality – the WINSTA® MINI pluggable installation connector with protection type IP40 from WAGO makes the electrical installation of electrical components visibly easier.

- effective protection against mismatching
- easy tool-free operation, a wide range of coding options
- with A coding for use in many general mains applications
- custom-engineered solutions
- convenient installation and commissioning

Data

Electrical data

Ratings per IEC/EN

Ratings per	IEC/EN 60664-1
Nominal voltage (III/3)	250 V
Rated impulse voltage (III/3)	4 kV
Rated current	16 A
Legend (ratings)	(III / 3) ≙ Overvoltage category III / Pollution degree 3

Ratings per UL 1977

Note for the US market	Some versions may also be used for current interruption in accordance with the UL certificate in select applications with currents below 5 A and voltages up to 600 V. For further information, please contact your local sales office.
Rated voltage (UL 1977)	600 V
Rated current UL 1977	14 A

General

Note on contact resistance	approx. 1 mΩ of contact resistance approx. 0.25 mΩ contact transition plug/socket
----------------------------	--

Subject to changes. Please also observe the further product documentation!



Connection data

Connection points	2
Total number of potentials	2

Connection 1

Connection technology	Push-in CAGE CLAMP®
Actuation type	Operating tool Push-in
Nominal cross-section	1.5 mm ² / 16 AWG
Solid conductor	0.25 ... 1.5 mm ² / 22 ... 16 AWG
Solid conductor; push-in termination	0.75 ... 1.5 mm ² / 20 ... 16 AWG
Stranded conductor	0.25 ... 1 mm ² / 22 ... 18 AWG
Fine-stranded conductor	0.25 ... 1.5 mm ² / 22 ... 16 AWG
Fine-stranded conductor; with insulated ferrule	0.25 ... 0.75 mm ² / 22 ... 20 AWG
Fine-stranded conductor; with uninsulated ferrule	0.25 ... 0.75 mm ² / 22 ... 20 AWG
Fine-stranded conductor; with ferrule; push-in termination	0.75 mm ² / 20 AWG
Strip length	9 mm / 0.35 inches
Pole number	2
Conductor entry direction to mating direction	0°
Strip length (outer insulation)	32 mm

Physical data

Pin spacing	4.4 mm / 0.173 inches
Width	15.6 mm / 0.614 inches
Height	13.2 mm / 0.52 inches
Depth	61.6 mm / 2.425 inches

Mechanical Data

Application	General mains applications
Coding	A
Variable coding	No
Marking	N L
Potential marking	N L
Mating force of a plug-in connection	approx. 20 ... 70 N (depending on pole number)
Retention force of a plug-in connection	Locked: > 80 N

Subject to changes. Please also observe the further product documentation!



Unmating force of a plug-in connection	Unlocked: approx. 20 ... 70 N (depending on pole number)
Number of mating cycles	200, without resistive load
Protection type	IP40

Plug-in connection

Contact type (pluggable connector)	Male connector/plug
Connector (connection type)	for conductor
Mismating protection	Yes
Note on mismating protection	All <i>WINSTA</i> [®] components are 100% protected against mismating when: a.) plugging different numbers of poles b.) plugging while rotated 180 c.) plugging while laterally staggered d.) plugging one pole
Locking lever	Can be retrofitted
Locking of plug-in connection	locking lever
Note on locking system	All connectors for mounted installations (snap-in versions for lighting fixtures or devices, all types of PCB and distribution connectors) are factory-equipped with locking levers to ensure plugs and sockets are securely locked. Additional locking levers are only required for flying leads (plug/socket).
Strain relief	strain relief housing

Material Data

Note (material data)	Information on material specifications can be found here
Color	black
Cover color	gray
Material group	I
Insulation material	Polyamide (PA66)
Flammability class per UL94	V0
Clamping spring material	Chrome-nickel spring steel (CrNi)
Contact material	Copper or copper alloy; surface-treated
Contact plating	Tin
Fire load	0.197 MJ
Weight	5.5 g

Subject to changes. Please also observe the further product documentation!

Environmental requirements

Processing temperature	-5 ... +40 °C
Continuous operating temperature	-35 ... +85 °C
Note on continuous operating temperature	Insulating parts for temperatures ≤ 105 °C

Commercial data



Product Group	20 (Winsta)
eCl@ss 10.0	27-44-06-05
eCl@ss 9.0	27-44-06-05
ETIM 8.0	EC002560
ETIM 7.0	EC002560
PU (SPU)	50 pcs
Packaging type	box
Country of origin	DE
GTIN	4045454232894
Customs tariff number	85366990990

Environmental Product Compliance

RoHS Compliance Status	Compliant, No Exemption
------------------------	-------------------------

Approvals / Certificates

General approvals

Logo	Approval	Additional Approval Text	Certificate name
	CCA DEKRA Certification B.V.	EN 61535	71- 123231
	CCA DEKRA Certification B.V.	IEC 61535	NL-85020
	cURus Underwriters Laboratories Inc.	UL 1977	E45171

Declarations of conformity and manufacturer's declarations

Logo	Approval	Additional Approval Text	Certificate name
------	----------	--------------------------	------------------

Subject to changes. Please also observe the further product documentation!

WAGO GmbH & Co. KG
 Hansastr. 27
 32423 Minden
 Phone: +49571 887-0 | Fax: +49571 887-169
 Email: info.de@wago.com | Web: www.wago.com

Do you have any questions about our products?
 We are always happy to take your call at +49 (571) 887-44222.



EU-Declaration of Conformity
WAGO GmbH & Co. KG

-

-





UK-Declaration of Conformity
WAGO GmbH & Co. KG





-

-

Approvals for marine applications

Logo	Approval	Additional Approval Text	Certificate name
	ABS American Bureau of Shipping	Steel Vessel Rules	19- HG1869855- PDA
	DNV GL Det Norske Veritas, Germanischer Lloyd	-	TAE00001Z6
	LR Lloyds Register	EN 61535	08/20047 (E2)







Counterpart

	Item no.890-102 Socket; with strain relief housing; 2-pole; Cod. A; 1,50 mm ² ; black	www.wago.com/890-102
	Item no.890-1606 T-distribution connector; 2-pole; Cod. A; 1 input; 2 outputs; 2 locking levers; black	www.wago.com/890-1606
	Item no.890-1615 T-distribution connector; 2-pole; Cod. A; 1 input; 2 outputs; 3 locking levers; for flying leads; black	www.wago.com/890-1615
	Item no.890-1634 h-distribution connector; 2-pole; Cod. A; 1 input; 2 outputs; outputs on one side; 2 locking levers; black	www.wago.com/890-1634
	Item no.890-1636 h-distribution connector; 2-pole; Cod. A; 1 input; 2 outputs; outputs on one side; 3 locking levers; for flying leads; black	www.wago.com/890-1636

Subject to changes. Please also observe the further product documentation!





WAGO GmbH & Co. KG
Hansastr. 27
32423 Minden
Phone: +49571 887-0 | Fax: +49571 887-169
Email: info.de@wago.com | Web: www.wago.com

Do you have any questions about our products?
We are always happy to take your call at +49 (571) 887-44222.

	Item no.890-202/342-000 Socket; with strain relief housing; 2-pole; Cod. A; 1,50 mm ² ; black	www.wago.com/890-202/342-000
	Item no.890-202 Socket; 2-pole; Cod. A; 1,50 mm ² ; black	www.wago.com/890-202
	Item no.890-702 Snap-in socket; 2-pole; Cod. A; 1,50 mm ² ; black	www.wago.com/890-702
	Item no.890-802 Socket for PCBs; straight; 2-pole; Cod. A; black	www.wago.com/890-802
	Item no.890-802/011-000 Socket for PCBs; angled; 2-pole; Cod. A; black	www.wago.com/890-802/011-000
	Item no.891-8992/005-101 pre-assembled interconnecting cable; Eca; Socket/plug; 2-pole; Cod. A; H05VV-F 2 x 1.0 mm ² ; 1 m; 1,00 mm ² ; black	www.wago.com/891-8992/005-101
	Item no.891-8992/105-101 pre-assembled connecting cable; Eca; Socket/open-ended; 2-pole; Cod. A; H05VV-F 2 x 1.0 mm ² ; 1 m; 1,00 mm ² ; black	www.wago.com/891-8992/105-101

Required accessories

Locking levers

Locking system		
	Item no.: 890-111 Locking lever; for flying leads; for tool operation; black	www.wago.com/890-111
	Item no.: 890-101 Locking lever; for manual operation; black	www.wago.com/890-101
	Item no.: 890-121 Locking lever; for manual operation; white	www.wago.com/890-121
	Item no.: 890-131 Locking lever; for flying leads; for tool operation; white	www.wago.com/890-131

Optional accessories

Cover

Cover		
-------	--	--

Subject to changes. Please also observe the further product documentation!



Item no.: 897-2001

Protective cap; Type1; for sockets and plugs; PVC; red

www.wago.com/897-2001

Mounting

Mounting accessories



Item no.: 890-310

Mounting carrier; 2- to 5-pole; for flying leads; black

www.wago.com/890-310



Item no.: 890-311

Mounting carrier; 2- to 5-pole; for flying leads; white

www.wago.com/890-311

Tool

Operating tool



Item no.: 210-719

Operating tool; Blade: 2.5 x 0.4 mm; with a partially insulated shaft

www.wago.com/210-719



Item no.: 890-382

Operating tool; 2-way; green

www.wago.com/890-382

Downloads

Documentation

Bid Text

890-112 X81 - Datei	2019 Feb 19	xml 3.1 kB	Download
890-112 doc - Datei	2015 Jun 8	doc 23.6 kB	Download

CAD/CAE-Data

CAD data

2D/3D Models 890-112	URL	Download
----------------------	-----	----------

CAE data

EPLAN Data Portal 890-112	URL	Download
---------------------------	-----	----------

Subject to changes. Please also observe the further product documentation!

ZUKEN Portal 890-112

[URL](#)

[Download](#)

WSCAD Universe 890-112

[URL](#)

[Download](#)

Environmental Product Compliance

Compliance Search

Environmental Product Compliance 890-112

[URL](#)

[Download](#)

Plug; with strain relief housing; 2-pole; 1,50 mm²; black

Installation Notes

Conductor termination

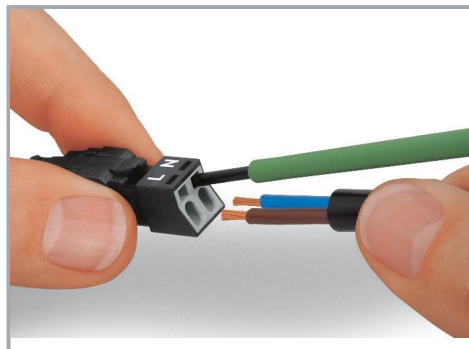
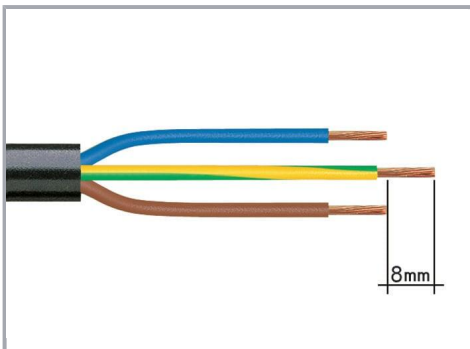

1. Strip length, outer insulation = 30 mm (2-pole), 37 mm (3-pole), 45 mm (4- and 5-pole)

2. Strip length = 9 mm

3. Extended ground conductor = 8 mm

To terminate fine-stranded conductors, open the clamping unit via screwdriver – 2.5 mm blade width – and insert a stripped conductor until it hits the backstop.

Terminate solid conductors by simply pushing them in.

Subject to changes. Please also observe the further product documentation!

WAGO GmbH & Co. KG

Hansastr. 27

32423 Minden

Phone: +49571 887-0 | Fax: +49571 887-169

Email: info.de@wago.com | Web: www.wago.com

Do you have any questions about our products?

We are always happy to take your call at +49 (571) 887-44222.

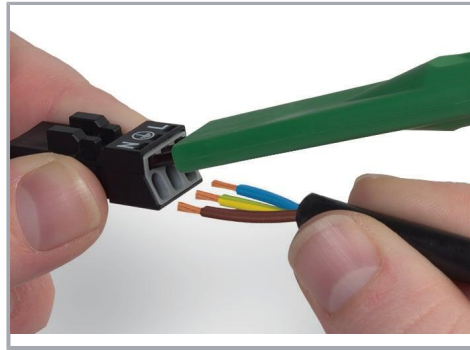
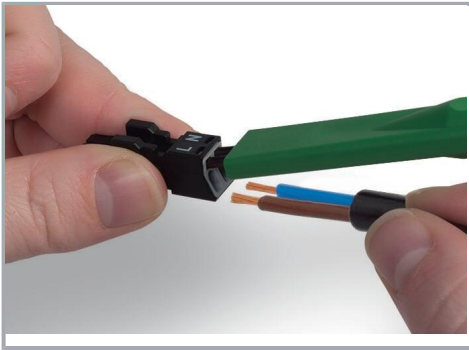

To terminate fine-stranded conductors, open clamping units via operating tool (890-382) and insert stripped conductors until they hit backstop.

To terminate fine-stranded conductors, open clamping units via operating tool (890-383) and insert stripped conductors until they hit backstop.

Terminate solid conductors by simply pushing them in.

Terminate solid conductors by simply pushing them in.

Installation

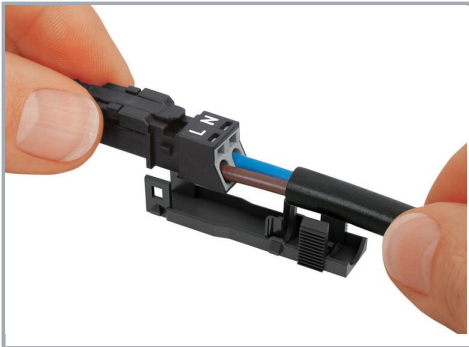

Latch the wired connector into the base of the strain relief housing.

Push down strain relief clamp by hand.

Subject to changes. Please also observe the further product documentation!



Push down strain relief clamp with 2.5 mm screwdriver alternately on both sides.

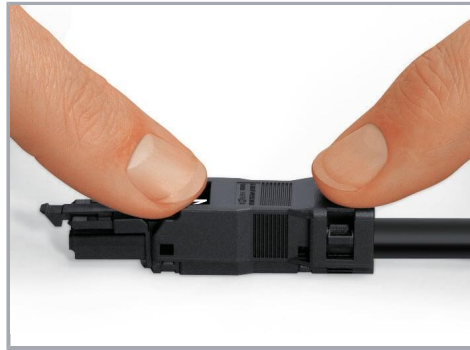

Latch the top of the strain relief housing.



The printed marking of the connector is clearly visible in the openings of the strain relief housing.

Product family

WINSTA® MINI

[Show all products from the family](#)

Subject to changes. Please also observe the further product documentation!