

# Features

- Qualified with 65kV/μs @ Vcommon mode =1KV
- 6V Output for GaN driver Applications
- Pot-Core Transformer with separated windings
- High 6.4kVDC/sec Isolation in compact size
- Low isolation capacitance (10pF max.)
- UL/IEC/EN62368-1 and IEC/EN60950-1 certified

# Unregulated Converters



## RxxP06S

**1 Watt  
SIP7  
Output for GaN  
Application**



### Description

High slew rate GaN transistor drivers require an isolated 6V supply with high isolation voltage and low isolation capacitance. The RxxP06S series have been specially designed to fulfill this demanding requirement with 6400VDC/sec isolation and <10pF isolation capacitance. The internal transformer uses a pot-core to physically separate the input and output windings, yet the converter still fits into an industry standard SIP7 case. Input voltage options of 5, 12, 15 or 24V are available and the RxxP06S series is safety certified to the latest UL/IEC62368 standard.

### Selection Guide

Part Number	nom. Input Voltage [VDC]	Output Voltage [VDC]	Output Current [mA]	Efficiency typ. <sup>(1)</sup> [%]	max. Capacitive Load <sup>(2)</sup> [μF]
R05P06S	5	6	167	76	1000
R12P06S	12	6	167	81	1000
R15P06S	15	6	167	79	1000
R24P06S	24	6	167	80	1000

#### Notes:

Note1: Efficiency is tested at nominal input and full load at +25°C ambient

Note2: Max Cap Load is tested at nominal input and full resistive load



UL62368-1 certified  
CAN/CSA-C22.2 No. 62368-1-14 certified  
IEC/EN62368-1 certified  
IEC/EN60950-1 certified  
CB Report

### Model Numbering

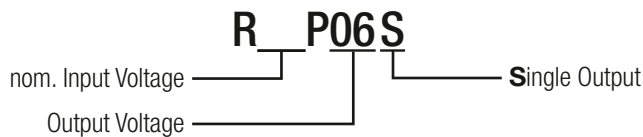

[www.recom-power.com/eval-ref-boards](http://www.recom-power.com/eval-ref-boards)

[www.recom-power.com/bier](http://www.recom-power.com/bier)

**Specifications** (measured @ Ta= 25°C, nom. Vin, full load and after warm-up unless otherwise stated)

BASIC CHARACTERISTICS				
Parameter	Condition	Min.	Typ.	Max.
Internal Input Filter				capacitor type
Input Voltage Range	nom. Vin = 5VDC 12VDC 15VDC 24VDC	4.5VDC 10.8VDC 13.5VDC 21.6VDC		5.5VDC 13.2VDC 16.5VDC 26.4VDC
Minimum Load <sup>(3)</sup>		0%		
Internal Operating Frequency	nom. Vin = 5VDC, 12VDC, 15VDC 24VDC	20kHz	55kHz 60kHz	
Output Ripple and Noise	20MHz BW			200mVp-p

**Notes:**

Note3: Operation below 10% load won't harm the converter, but specifications may not be met

**Efficiency vs. Load**

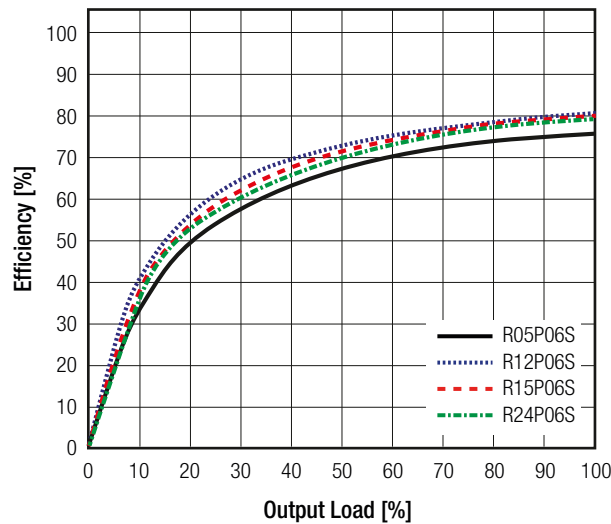

REGULATIONS		
Parameter	Condition	Value
Output Accuracy		±5.0% max.
Line Regulation	low line to high line, full load	1.2% typ. / 1% of Vin
Load Regulation	10% to 100% load nom. Vin = 5VDC, 12VDC 15VDC 24VDC	6.0% typ. / 15.0% max. 5.0% typ. / 15.0% max. 4.0% typ. / 15.0% max.

continued on next page

**Specifications** (measured @ Ta= 25°C, nom. Vin, full load and after warm-up unless otherwise stated)

**Tolerance Envelope**

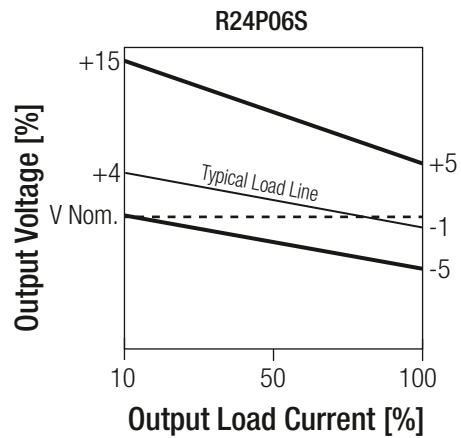
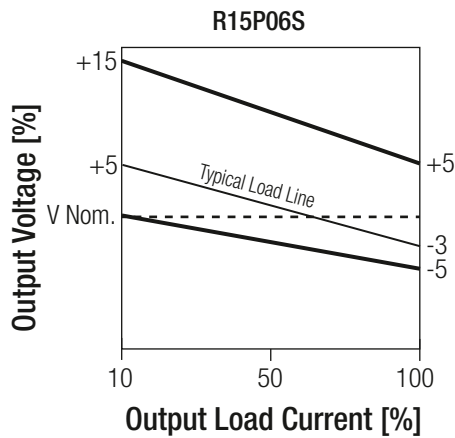
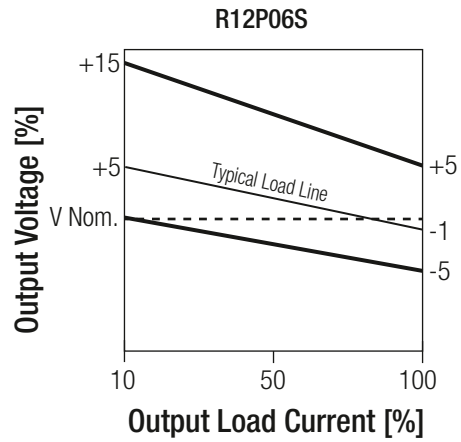
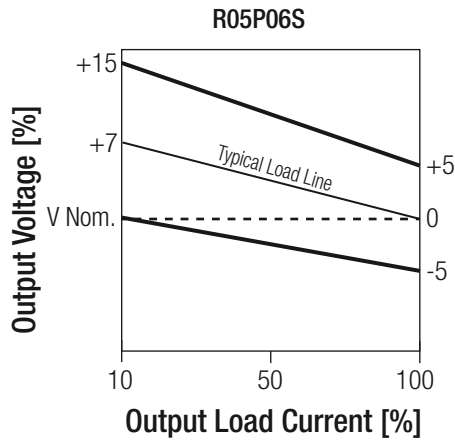

**PROTECTIONS**

Parameter	Type		Value
Isolation Voltage <sup>(4)</sup>	I/P to O/P	tested for 1 second	6.4kVDC
		rated for 1 minute	5.2kVDC
Isolation Resistance			15GΩ min.
Isolation Capacitance			10pF max.
Insulation Grade			basic
Internal	clearance/creepage		2.0mm
External	clearance/creepage		7.0mm

**Notes:**

Note4: For repeat Hi-Pot testing, reduce the time and/or the test voltage

Note5: Refer to local safety regulations if input over-current protection is required. Recommended fuse: slow blow type

**Specifications** (measured @ Ta= 25°C, nom. Vin, full load and after warm-up unless otherwise stated)

**ENVIRONMENTAL**

Parameter	Condition		Value
Operating Temperature Range	full load @ natural convection 0.1m/s (see graph)		-40°C to +90°C
Maximum Case Temperature			+105°C
Temperature Coefficient			±0.02%/K
Thermal Impedance	0.1m/s, horizontal		30K/W
Operating Humidity	non-condensing		5% - 95% RH max.
Operating Altitude			3000m
Pollution Degree			PD2
MTBF	according to MIL-HDBK-217F, G.B.	+25°C	2000 x 10 <sup>3</sup> hours
		+90°C	700 x 10 <sup>3</sup> hours

**Derating Graph**

(@ Chamber and natural convection 0.1 m/s)

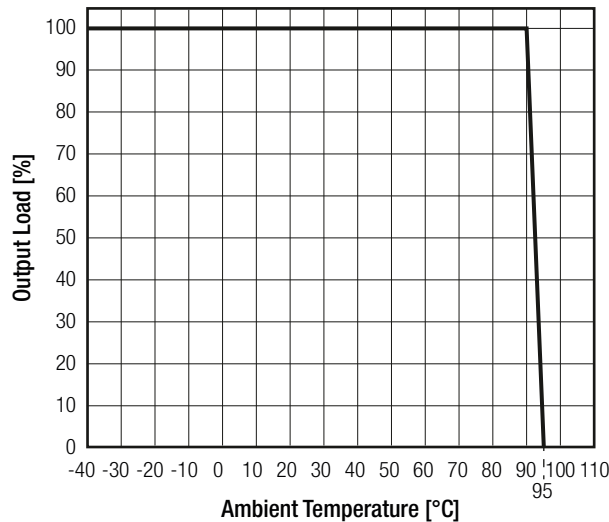

**SAFETY AND CERTIFICATIONS**

Certificate Type	Report / File Number	Standard
Information Technology Equipment, General Requirements for Safety	E224736-A56-UL	UL60950-1, 2nd Edition, 2014 CAN/CAS-C22.2 No. 60950-1-07, 2nd Edition, 2014
Information Technology Equipment, General Requirements for Safety (LVD)	1602031	EN60950-1, 2nd Edition 2006, +A2:2013 IEC60950-1, 2nd Edition 2005 + A2:2013
Audio/Video, information and communication technology equipment - Part1: Safety requirements (CB Scheme)	ATTCB106076	IEC62368-1:2014, 2nd Edition
Audio/Video, information and communication technology equipment - Part1: Safety requirements		EN62368-1:2014 + A11:2017
Audio/Video, information and communication technology equipment - Part1: Safety requirements	E224736-A56-UL	UL62368-1, 2nd Edition, 2014 CSA CAN No. 62368-1-14, 2nd Edition
EAC	RU-AT.49.09571	TP TC 004/2011
RoHS 2+		RoHS 10/10, 2011/65/EU + AM-2015/863

EMI Compliance	Condition	Standard / Criterion
Electromagnetic compatibility of multimedia equipment - Emission requirements	with external components (see filter suggestions)	EN55032, Class B

continued on next page

**Specifications** (measured @ Ta= 25°C, nom. Vin, full load and after warm-up unless otherwise stated)

### EMC Filtering Suggestion according to EN55032 Class A and Class B

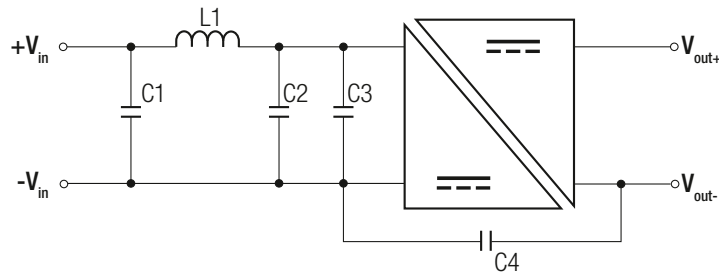

#### Component List Class A

MODEL	C1	C2	C3	C4	L1
R05P06S	N/A	22µF MLCC	N/A	N/A	N/A
R12P06S		10µF MLCC	4.7µF MLCC		
R15P06S					
R24P06S					

#### Component List Class B

MODEL	C1	C2	C3	C4	L1
R05P06S	10µF MLCC	10µF MLCC	N/A	1nF / 10kV	470µH, 0.44A, 0.969W Würth: 744776247
R12P06S					
R15P06S					
R24P06S					

### DIMENSION and PHYSICAL CHARACTERISTICS

Parameter	Type	Value
Material	case potting PCB	non-conductive black plastic, (UL94 V-0) epoxy, (UL94 V-0) FR4, (UL94 V-0)
Dimension (LxWxH)		19.5 x 9.8 x 12.5mm
Weight		4.3g typ.

#### Dimension Drawing (mm)

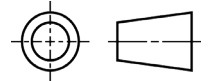
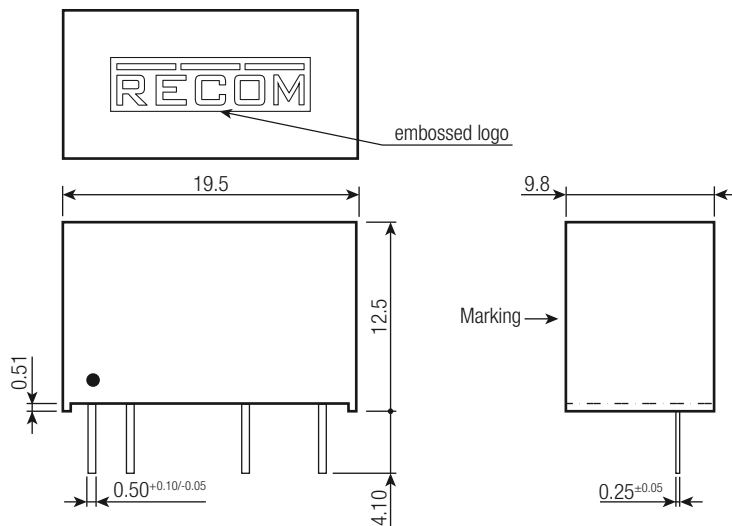

#### Pin Connection

Pin #	Single
1	+Vin
2	-Vin
5	-Vout
7	+Vout

Tolerance: xx.x= ±0.5mm

xx.xx= ±0.25mm

Pin dimension: ±0.1mm

#### Recommended Footprint Details

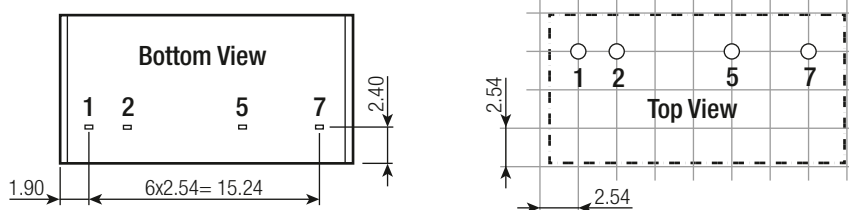

**Specifications** (measured @ Ta= 25°C, nom. Vin, full load and after warm-up unless otherwise stated)

**INSTALLATION and APPLICATION**

**Typical GaN Application Circuit**

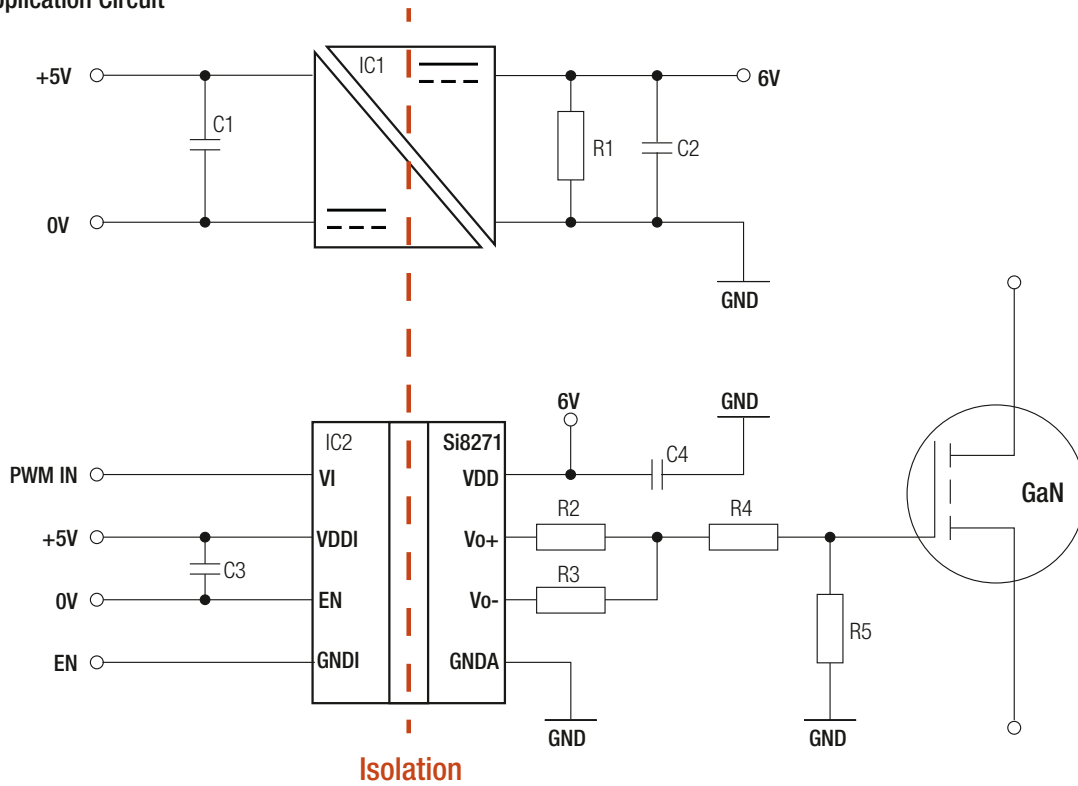

**PACKAGING INFORMATION**

Parameter	Type	Value
Packaging Dimension (LxWxH)	tube	530.0 x 21.0 x 18.0 mm
Packaging Quantity		25pcs
Storage Temperature Range		-55°C to +125°C
Storage Humidity	non-condensing	95% RH max.

The product information and specifications may be subject to changes even without prior written notice. The product has been designed for various applications; its suitability lies in the responsibility of each customer. The products are not authorized for use in safety-critical applications without RECOM's explicit written consent. A safety-critical application is an application where a failure may reasonably be expected to endanger or cause loss of life, inflict bodily harm or damage property. The applicant shall indemnify and hold harmless RECOM, its affiliated companies and its representatives against any damage claims in connection with the unauthorized use of RECOM products in such safety-critical applications.