

# Section 8

## Operating Mechanisms and Disconnect Switches



UL508 Motor Disconnect Switch



UL98 Fusible Switch



UL508 VLS Switch



UL98 VLS Switch

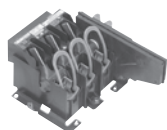

UL98 Style Flange Handle Disconnect Switch



9421 Type L Circuit Breaker Mechanism



9422 Type R Circuit Breaker Mechanism

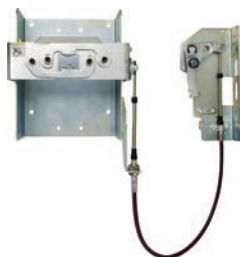

9422 Type C Circuit Breaker Cable Operator

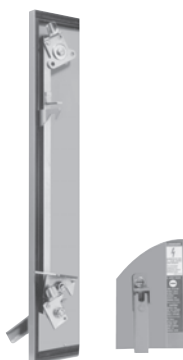

9423 Door Closing Mechanisms

### Operating Mechanisms and Disconnect Switches 8-2

Selection Guide 8-2

### UL 508 Motor Disconnect Switches 8-3

Mini-Vario and Vario™ Assembled and Enclosed Switches 8-3

Mini-Vario and Vario™ Accessories 8-7

MD Motor Disconnect Switches 8-8

### UL 60947-4-1 and UL 98 Disconnect Switches 8-9

TeSys™ VLS Disconnect Switches 8-9

Disconnect Switches, 16–125 A 8-9

TeSys™ VLS Accessories 8-11

Fourth Pole Add-on 8-11

Add-on Blocks 8-12

Sequence and Maximum Combination of Add-on Blocks 8-13

Rotary Handles 8-16

Shaft Extensions, Terminal Covers, Fuse Holders, and Fuse Blocks 8-18

Dimensions: 16–125 A Disconnect Switches 8-19

Wiring Diagrams 8-22

Technical Specifications, VLS Range, 16–125 A 8-23

### UL 98 IEC Style Disconnect Switches 8-24

LK4 Nonfusible and GS2 Fusible Disconnect Switches 8-24

LK4 Nonfusible Disconnect Switches 8-24

GS2 Fusible Disconnect Switches 8-26

Cable Operator Kits for GS2 Switches 8-27

Accessories, LK4 Nonfusible and GS2 Fusible 8-27

Accessories 8-27

Dimensions, LK4 Nonfusible and GS2 Fusible 8-28

LK4JU3N / LK4MU3N / LK4QU3N, 100–400 A Nonfusible Disconnect

Switches—Dimensions 8-28

GS2QU3N, 400 A Fusible Disconnect Switches, Class J Fuses 8-32

### Flange Mounted and Cable Operated 8-32

Disconnect Switches 8-33

Accessories, Disconnect Switches 8-34

Dimensions, Disconnect Switches 8-37

### Operating Mechanisms for Circuit Breakers 8-39

Door Mounted 8-39

Flexible Cable Mechanisms 8-41

Selection Guide



Class	MD	Vario	Enclosed Vario	LK4	VLS	
Type	Motor disconnect switches	Manual motor control switches	Motor disconnect switch	Nonfusible IEC style disconnect switches	Disconnect switches	Disconnect switches
UL Rating	UL 508	UL 508	UL508	UL 98	UL 508	UL 98
Handle Type	Rotary	Rotary	Rotary	Rotary	Rotary	Rotary
Mounting	—	Door or panel	—	—	DIN Rail (Rear Mounting) Door Mounting	DIN Rail (Rear Mounting) Door Mounting
Voltage (max.)	600 Vac	600 Vac	600 Vac	600 Vac	690 Vac	690 Vac
Current Ratings	30–60	10–115	UL-20-115A, IEC 32 - 175	30–1200	16–63 A	63–125 A
Horsepower Ratings (max.)	7.5–40	2–60	2–60	7.5–500	1–30	3–60
Enclosure Type	Non-Metallic NEMA 1, 3, 3R, 4, 4X, and 12	Metallic: NEMA 1, 12, 4, 4X Plastic: IP55, NEMA Type 4X	NEMA 1, 12, 3R 4, 4X	Handle ratings: NEMA 1, 3R, 4, 4X, 12	NEMA 1, 12, 3R, 4, and 4X; IEC IP65, IP66	NEMA 1, 12, 3R, 4, and 4X; IEC IP65, IP66
Accessories	Power poles and auxiliary contacts	Power poles and auxiliary contacts	Power poles and auxiliary contacts	Auxiliary contacts and power lugs	Power poles and auxiliary contacts	Power poles and auxiliary contacts
Approvals	UL File E164864 IEC standard 60947-3	UL File E164864 NLRV CSA File LR 81630 Class 3211 05	UL	UL File E191098 WP2X / WP2X7 CSA 703149 Class 4652 04	UL File E487906 UL60947-4-1 / CSA 22.2 n° 60947-4-1-14	UL File E487907 UL98/CSA 22.2 n° 4
Page	page 8-8	page 8-3	page 8-4	page 8-24	page 8-9	page 8-9



Class	GS2	9422	9421	9422	9423
Type	Fusible IEC style disconnect switches	NEMA style fused or non-fusible disconnect switches	Circuit breaker operating mechanisms	Circuit breaker operating mechanisms	Door closing mechanisms
UL Rating	UL 98	UL98	—	—	—
Handle Type	Rotary	Flange Adjustable rod or cable mechanism	Rotary	Flange Adjustable rod or cable mechanism	Rotary, works in conjunction with 9422 handle mechanisms
Mounting	Flange with cable mechanism panel	Panel or bracket mount	Panel	Panel	—
Load Voltage (max.)	600 Vac	600 Vac	600 Vac	600 Vac	—
Current Ratings	30–800	30–400	Circuit breaker frame sizes 100–1200	Circuit breaker frame sizes 100–1200	—
Horsepower Ratings (max.)	7.5–500	7.5–350	—	—	—
Enclosure Type	Handle ratings: NEMA 1, 3R, 4, 4X, 12	Handle ratings: NEMA 1, 3R, 4, 4X, 12	Handle ratings: NEMA 1, 3R, 4, 4X, 12	Handle ratings: NEMA 1, 3R, 4, 4X, 12	Handle ratings: NEMA 4 and 12 sheet steel or stainless
Accessories	Auxiliary contacts and power lugs	Auxiliary contacts	Auxiliary contacts	Auxiliary contacts	Right or left-hand operation
Approvals	UL File E191098 WP2X / WP2X7 CSA 703149 Class 4652 04	UL File E52639 WHTY2 CSA LR44199 Class 4652-04	UL File E62922 DIHS2 CSA LR44199 Class 3211 07	UL File E62922 DIHS2 CSA LR44199 Class 3211 07	—
Page	page 8-26	page 8-33	page 8-39	page 8-41	Refer to Supplemental Digest Section 15

**Identification System**

Mini-Vario and Vario rotary manual motor-control switches from 12–175 A are suitable for on-load making and breaking of resistive or mixed resistive inductive circuits where frequent operation is required. They can also be used for direct switching of motors in utilization categories AC-3 and DC-3 specific to motors. Vario manual motor-control switches are suitable for isolator applications with fully visible indication (since the handle cannot be in the open position unless all the contacts are actually open and separated by the appropriate isolating distance), and the handles are padlockable.

The Mini-Vario and Vario catalog numbers are described in Table 8.1.

**Table 8.1: Identification System**

		V	CF	N12	GE
<b>Model (V-Vario, K-Operator)</b>					
<b>Operator Type/ Accessory Designation</b>					
<b>CD</b>	Single hole Red & Yellow				
<b>CF</b>	Four hole Red & Yellow				
<b>CCD</b>	Single hole Red & Yellow w/ extension shaft				
<b>CCF</b>	Four hole Red & Yellow w/ extension shaft				
<b>Blank</b>	No operator or accessory				
<b>BD</b>	Single hole Black and Gray				
<b>BF</b>	Four hole Black and Gray				
<b>VE</b>	Switch with Red handle installed on unit (one padlock only)				
<b>VD</b>	Switch with Black handle installed on unit (no padlock provision)				
<b>Z</b>	Accessory, power pole, neutral or ground				
<b>Switch Type (Switches and contacts are dual rated, UL/IEC).</b>					
<b>Blank</b>		<b>1</b>	Vario 20/32 A		
<b>N12</b>	Mini-Vario 10/12 A	<b>2</b>	Vario 25/40 A		
<b>N20</b>	Mini-Vario 16/20 A	<b>3</b>	Vario 45/63 A		
<b>02</b>	Vario 10/12 A	<b>4</b>	Vario 63/80 A		
<b>01</b>	Vario 16/20 A	<b>5</b>	Vario 100/125 A		
<b>0</b>	Vario 20/25 A	<b>6</b>	Vario 115/175 A		
<b>Enclosure Type (if applicable)</b>					
<b>Blank</b>	No Enclosure	<b>G30, A30, W30</b> Type 1/12/4/4X Metallic (Class 9421)			
<b>GE</b>	Mini-Vario IP55 Non-Metallic	<b>GU</b> Vario IP55 Non-Metallic			



VCFN12GE

**Mini-Vario**

**Table 8.2: Assembled Switches—Degree of Protection IP65, Type 1 and 12**

Rating (A)		Complete Switches for Door Mounting (3-Padlock)		Complete Switches for Rear Mounting, Includes Extension Shaft (3-Padlock)
		Red/Yellow (Single Hole)	Black/Gray (Single Hole)	Red/Yellow (Single Hole)
UL	IEC	Catalog No.	Catalog No.	Catalog No.
10	12	VCDN12	VBDN12	VCCDN12
16	20	VCDN20	VBDN20	VCCDN20



VN12



VN12/KCC1YZ



VBDN12



VCDN12



VCCDN20

**Table 8.3: Mini-Vario Enclosed Switches**

Catalog No.	Complete Switches Mounted in IP55 Non-Metallic Enclosure
	Description
VCFN12GE	Red/Yellow Mounted In Sealable Enclosure, Non-UL Listed, Non-NEMA Rated
VCFN20GE	

**Table 8.4: Component Parts**

Catalog No.	Description
VN12 [1]	10/12 A switch only
VN20 [1]	16/20 A switch only
VZN12 [1]	Add on power pole for 10/12 A switch
VZN20 [1]	Add on power pole for 16/20 A switch
VZN11	Neutral Pole with early make, late break for VN12 or VN20 switch
VZN14	Grounding module for VN12 or VN20
VZN05	N.O. late make auxiliary contact [2]
VZN06	N.C. early break auxiliary contact [2]
VZN26	Single-pole shroud for auxiliary contacts
VZN08	Three-pole shroud for VN12 or VN20

**Table 8.5: Operators and Accessories**

Catalog No.	Description
KCC1YZ	45 x 45 mm Red & Yellow operator
KCD1PZ	60 x 60 mm Red & Yellow operator
KAD1PZ	60 x 60 mm Black & Gray operator
VZN17	300–340 mm shaft extension
VZN30	400–430 mm shaft extension
KZ32	Door interlocking plate for 45 or 60 mm operator
KZ83	Door mounting plate for 45 or 60 mm operator

[1] Switches/contacts are dual rated (UL/IEC).  
[2] Auxiliary contacts are dual rated (UL/IEC 10/12 A).



**Vario**

**Table 8.6: NEMA Type 1 and 12 Assembled Switches for Door Mounting**

Rating (A)		Complete Switches (Switch and Handle) for Door Mounting (3-padlock)			
		Red/Yellow (Four Hole)	Black/Gray (Four Hole)	Red/Yellow (Single Hole)	Black/Gray (Single Hole)
UL	IEC	Catalog No.	Catalog No.	Catalog No.	Catalog No.
10	12	VCF02	VBF02	VCD02	VBD02
16	20	VCF01	VBF01	VCD01	VBD01
20	25	VCF0	VBF0	VCD0	VBD0
20	32	VCF1	VBF1	VCD1	VBD1
25	40	VCF2	VBF2	VCD2	VBD2
45	63	VCF3	VBF3	—	—
63	80	VCF4	VBF4	—	—
100	125	VCF5	VBF5	—	—
115	175	VCF6	VBF6	—	—



**Table 8.7: NEMA Type 1 and 12 Assembled Switches for Rear Mounting**

Rating (A)		Complete Switches for Rear Mounting with Extension Shaft (3-Padlock) <sup>[3]</sup>		Switches with Handles Installed on Unit, DIN Rail Mount Only	
		Red/Yellow (Four Hole)	Red/Yellow (Single Hole)	Red/Yellow (1-Padlock)	Black/Gray (No-Padlock)
UL	IEC	Catalog No.	Catalog No.	Catalog No.	Catalog No.
10	12	VCCF02	VCCD02	—	—
16	20	VCCF01	VCCD01	—	—
20	25	VCCF0	VCCD0	VVE0	VVD0
20	32	VCCF1	VCCD1	VVE1	VVD1
25	40	VCCF2	VCCD2	VVE2	VVD2
45	63	VCCF3	—	VVE3	VVD3
63	80	VCCF4	—	VVE4	VVD4
100	125	VCCF5	—	—	—
115	175	VCCF6	—	—	—



**Vario Non-Metallic Enclosed Switches**

The Vario Motor Disconnect Switch is also offered as an enclosed switch. The three-pole version makes the Vario switch ideal for manual motor control applications. They are compact, easy to wire and connect, and come undrilled to allow cable entry positions.

**NOTE:** VC-GUN enclosures are UL approved.

**Table 8.8: Non-Metallic Enclosed Switch <sup>[4] [5]</sup>**

Ampere Size UL/IEC	IP55-PVC 3-Pole, NEMA Type 1 & 12	NEMA 4X Indoor	Hp Ratings			Catalog No.
			240 V	480 V	600 V	
20/32	X	—	5	10	10–15	VC1GUN
25/40	X	—	5–10	10–20	15–30	VC2GUN
45/63	X	—	10–15	20–30	30–40	VC3GUN
63/80	X	—	15	30	40	VC4GUN
100/125	X	X	25	50	50	VC5GUN
115/175	X	X	30	50	60	VC6GUN

**Table 8.9: Dimensions**

Type	No. of Poles	a	b	c	d	e	f
VC1GUN	3	6.5 (164)	4.8 (121)	3.4 (87)	5.6 (141)	3.9 (98)	5.2 (132)
VC2GUN							
VC3GUN							
VC4GUN	3	7.6 (193)	6.5 (164)	3.4 (87)	6.7 (170)	5.6 (141)	5.2 (132)
VC5GUN	3	11.5 (291)	9.5 (241)	5.0 (128)	10.6 (269)	8.6 (219)	7.5 (191)
VC6GUN							

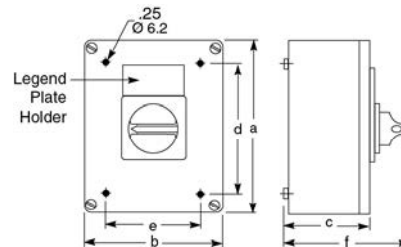

**VC-GUN**

[3] Complete switch includes handle operator, shaft, door interlock plate, and line terminal shroud.

[4] Assembled, includes switches mounted in enclosure with handle.

[5] Refer to Table 8.11 and Table 8.12 for horsepower ratings.



**Vario Metallic Enclosed Switches**

Vario switches meet UL508 requirements as both enclosed and open manual motor controllers. They are also marked "Suitable as Motor Disconnect" allowing installation on the load side of the motor branch circuit short-circuit and ground-fault protection. If motor branch circuit short-circuit and ground-fault protection is needed, use a GS1 or 9422 fusible switch or circuit breaker meeting NEC 430.52 requirements.

**Table 8.10: Metallic Enclosed Switches [6] [7]**

Rating (A)		Horsepower Ratings			NEMA Type 1	NEMA Type 12	NEMA Type 4/4X [7]
UL	IEC	240 V	480 V	600 V	Catalog No.	Catalog No.	Catalog No.
20	32	5	10	10	9421V1G30	9421V1A30	9421V1W30
25	40	5	10	15	9421V2G30	9421V2A30	9421V2W30

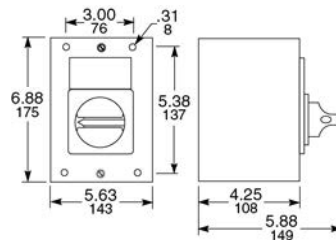

Class 9421 NEMA Type 1 V1G30, V2G30

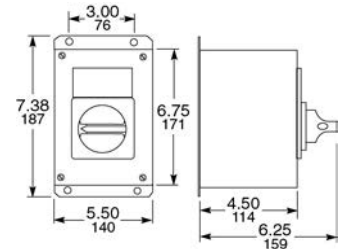

Class 9421 NEMA Type 4, 4X, 12 V1W30, V2W30, V1A30, V2A30

**Vario Manual Motor Control Switches**

The V1 and V2 come in metallic enclosures (NEMA Type 1, 4, 4X, and 12). The NEMA 1 enclosure comes with conduit knockouts top and bottom. To factory install a VZ7 auxiliary contact in these metallic enclosures, add Form X11 to the end of the catalog number (for example, 9421V1G30X11). To factory install a VZ20 auxiliary contact in these enclosures, add Form X20 to the end of the catalog number (for example, 9421V1W30X20).



Manual Motor Control Switch

**Table 8.11: Vario Manual Motor Control Switches, IEC**

Rating (A) IEC	kW Rating—3-Pole Switch Body					
	230 V	240 V	400 V	415 V	500 V	690 V
12	3	3	4	4	5.5	7.5
20	4	4	5.5	5.5	7.5	11
25	5.5	5.5	7.5	7.5	11	15
32	5.5	5.5	11	11	11	15
40	7.5	7.5	15	15	18.5	15
63	15	15	22	22	30	22
80	18.5	18.5	30	30	37	30
125	22	22	37	37	45	37
175	30	30	45	45	55	45

**Table 8.12: Vario Manual Motor Control Switches**

Rating (A)	Horsepower Rating			Shaft Size mm	3-Pole Switch Body Type
	240 V	480 V	600 V		
10	2	5	5	6	V02
16	3	7.5	7.5	6	V01
20	5	10	10	6	V0
20	5	10	10	6	V1
25	5	10	15	6	V2
45	10	20	30	8	V3
63	15	30	40	8	V4
100	25	50	50	8	V5
115	30	50	60	8	V6

**Table 8.13: Switch Body**

Rating (A)		Shaft Size mm	3-Pole Switch Body Type
UL	IEC		
10	12	6	V02
16	20	6	V01
20	25	6	V0
20	32	6	V1
25	40	6	V2
45	63	8	V3
63	80	8	V4
100	125	8	V5
115	175	8	V6

**NOTE:** Refer to Table 8.10 and Table 8.12 for horsepower ratings.

[6] Assembled, includes switches mounted in enclosure with handle.

[7] For indoor use only. The NEMA Type 4/4X enclosure is made of #304 stainless steel with 3/4 in. T&B stainless steel hubs on the top and bottom.



Single-Hole Operator



Four-Hole Operator (All except KDF3PZ and KBF3PZ)



Four-Hole Operator KDF3PZ and KBF3PZ



Low-Profile Handle KCD1YZ



KZ67

Table 8.14: NEMA Type 1 and 12 Handle Operators: V02–V2 (6 mm Shaft), V3–V6 (8 mm Shaft) [8]

Operator Type		Red/Yellow Single Hole 45 x 45 mm	Red/Yellow Four Hole 45 x 45 mm	Black/Gray Single Hole 45 x 45 mm	Black/Gray Four Hole 45 x 45 mm
Switches	No. of Padlocks	Catalog No.	Catalog No.	Catalog No.	Catalog No.
V02–V2	0	KCC1LZ	KCE1LZ	KAC1BZ	KAE1BZ
V02–V2	1	KCC1YZ	KCE1YZ	—	—
Operator Type		Red/Yellow Single Hole 60 x 60 mm	Red/Yellow Four Hole 60 x 60 mm	Black/Gray Single Hole 60 x 60 mm	Black/Gray Four Hole 60 x 60 mm
V02–V2	0	KDD1PZ	KDF1PZ	KBD1PZ	KBF1PZ
V3–V4	0	—	KDF2PZ	—	KBF2PZ
V02–V2	3	KCD1PZ	KCF1PZ	KAD1PZ	KAF1PZ
V3–V4	3	—	KCF2PZ	—	KAF2PZ
Operator Type		Red/Yellow Four Hole 90 x 90 mm	Black/Gray Four Hole 90 x 90 mm		
V5–V6	0	KDF3PZ	KBF3PZ		
V5–V6	3	KCF3PZ	KAF3PZ		

Table 8.15: Low Profile Handle Operators [8]

Operator Type		Red/Yellow Single Hole 60 x 60 mm	Red/Yellow Four Hole 60 x 60 mm	Black/Gray Single Hole 60 x 60	Black/Gray Four Hole 60 x 60 mm
Switches	No. of Padlocks	Catalog No.	Catalog No.	Catalog No.	Catalog No.
V02–V2	3	KCD1YZ	KCF1YZ	KADIXZ	KAF1XZ
V3–V4	3	—	KCF2YZ	—	KAF2XZ
Operator Type		Red/Yellow Four Hole 90 x 90 mm	Black/Gray Four Hole 90 x 90 mm		
V5–V6	3	KCG2YZ	KAG2XZ		

Table 8.16: Gasket Kits

Catalog No.	Description
KZ65	45 x 45 mm gasket for V02-V2 for 4-hole type handles (order in quantities of 5)—IP65
KZ66	60 x 60 mm gasket for V02-V2 for 4-hole type handles (order in quantities of 5)—IP65
KZ62	60 x 60 mm gasket for V3-V4 for 4-hole type handles (order in quantities of 5)—IP65
KZ67	90 x 90 mm gasket for V5-V6 for 4-hole type handles (order in quantities of 5)—IP65

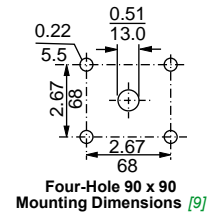
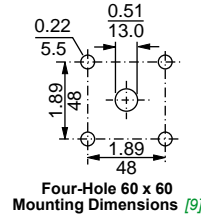
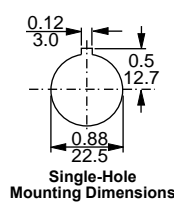
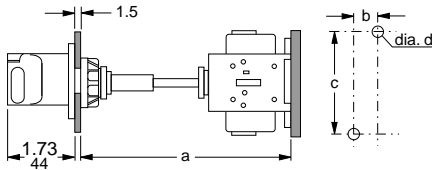

Table 8.17: Rear/Panel Mounting Switch Body Dimensions

Type	Shaft Extension	Dimensions							
		a		b		c		d	
		in.	mm	in.	mm	in.	mm	in.	mm
V02 to V2	VZ17	5.5–13.0	140–330	0.60	15	2.4	60	0.17	4.2
	VZ30	5.5–16.9	140–430						
V3 to V4	VZ18	5.5–12.6	140–320	0.79	20	2.4	60	0.20	5.2
	VZ31	5.5–16.5	140–420						
V5 to V6	VZ18	6.5–13.8	165–350	1.20	30	3.9	100	0.28	7.0
	VZ31	6.5–17.7	165–450						



[8] When using these handles for replacements on the non-metallic enclosed switches, the handle shaft that comes with the enclosure must be reused. See Section 15 of the Supplemental Digest.

[9] The door interlock plate included with VCC Kits has the same drilling as the handle operators.

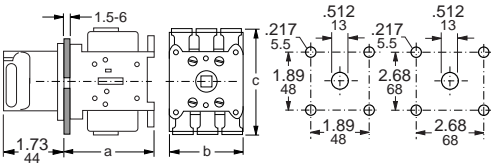

**Mini-Vario and Vario™ Accessories**

**Table 8.18: Door Mounting Switch Body Dimensions**

Switch Type	Dimensions						Weight Approx. lbs.
	a		b		c		
	in.	mm	in.	mm	in.	mm	
V02 to V2 [10]	2.83	72	2.17	55	2.91	74	0.44
V02 to V2	2.36	60	2.17	55	2.91	74	0.44
V3 to V4	2.56	65	2.36	60	3.27	83	1.10
V5 to V6	3.54	90	3.54	90	4.92	125	2.00

**Table 8.19: Shaft Extension and Door Interlock**

Switch Type	Maximum Panel Depth		Shaft Extension Kit	Door Interlock Plate	Door Mounting Plate
	in.	mm			
V02 to V2	13.0	330	VZ17	KZ32	KZ83
V3, V4	12.6	320	VZ18	KZ74	KZ81
V5, V6	13.8	351	VZ18	KZ74	KZ81
V02 to V2	16.9	429	VZ30	KZ32	KZ83
V3, V4	16.5	419	VZ31	KZ74	KZ81
V5, V6	17.7	450	VZ31	KZ74	KZ81

**Table 8.20: Accessories**

Switch Type	Line Side Terminal Shroud For Main Switch	Terminal Shroud for Add-on Power Pole	Terminal Shroud for Auxiliary Contact
V02 to V2	VZ8	VZ26	VZ29
V3, V4	VZ9	VZ27	VZ29
V5, V6	VZ10	VZ28	VZ29

**Table 8.21: Add-On Contact Modules**

Switch Type	Main Pole Module	Main Pole	Ampere Rating UL/IEC	Auxiliary Contacts Rated UL/IEC 10/12 A	
				1 N.O., 1 N.C.	2 N.O.
V02	VZ02	VZ02	10/12	VZ7 Early Break, Late Make	VZ20
V01	VZ01	VZ01	16/20		
V0	VZ0	VZ0	20/25		
V1	VZ1	VZ1	20/32		
V2	VZ2	VZ2	25/40		
V3	VZ3	VZ3	45/63		
V4	VZ4	VZ4	63/80		
V5, V6	—	—	—		

**Table 8.22: Add-On Contact Modules**

Switch Type	Neutral Modules Early Make/Late Break	Grounding Module	Auxiliary Contacts	
	Catalog No.	Catalog No.	Catalog No.	Description
V02-V2	VZ11	VZ14	VZ7	1 Late Make, N.O. & 1 Early Break, N.C.
V3-V4	VZ12	VZ15	VZ20	2 N.O. Contacts
V5-V6	VZ13	VZ16	—	—

**Table 8.23: Labeling Accessories**

Nameplate Holder with Nameplate		Nameplate Holder Only	Nameplate Only	
Size	Catalog No.	Catalog No.	Use With	Catalog No.
45 x 45 mm	KZ13	KZ14	KZ14	KZ76
60 x 60 mm	KZ15	KZ16	KZ16	KZ77
90 x 90 mm	KZ103	KZ101	KZ1010	KZ100

**Table 8.24: Shrouds**

Switch Type	3-Pole Shroud	Single-Pole Shroud	
	Catalog No.	For Add-On Power Pole	Catalog No.
V02-V2	VZ8	VZ02-VZ2, VZ11, & VZ14	VZ26
V3-V4	VZ9	VZ23, VZ4, VZ12, & VZ15	VZ27
V5-V6	VZ10	VZ13 & VZ16	VZ28
—	—	For 2-Pole Aux. Contact	VZ29

**Table 8.25: Main Pole Module Dimensions**

Switch Type	Dimensions						Weight Approx. lbs.
	a		b		c		
	in.	mm	in.	mm	in.	mm	
V02 to VZ2	0.63	16	2.9	74	1.38	35	0.10
VZ3 to VZ4	0.79	20	3.3	83	1.80	46	0.22

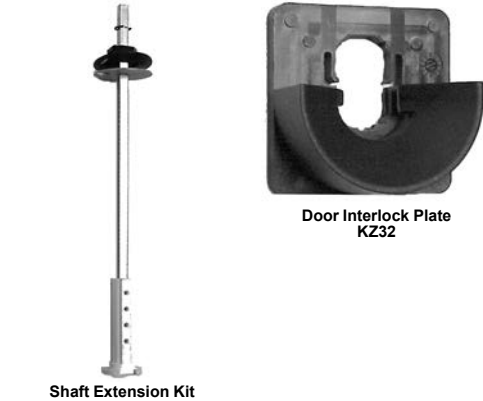

Door Interlock Plate KZ32

Shaft Extension Kit



Add-On Contact Module



Terminal Shroud for Main Switch VZ8



Terminal Shroud for Auxiliary Contact VZ29

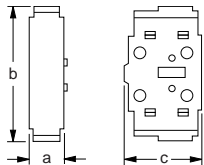

Main Pole Module

[10] Dimensions for single-hole mounting.

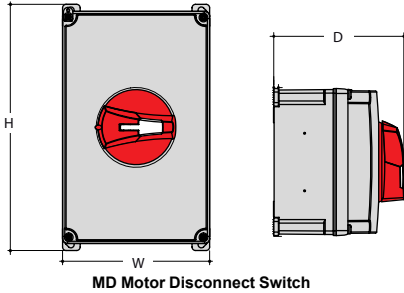

MD Motor Disconnect Switch

**MD Motor Disconnect Switches**

The MD motor disconnect switch is listed UL 508 Suitable for Motor Control (UL File E164864) and conforms to IEC standard 60947-3. It is in a compact NEMA 4X enclosure suitable for use in NEMA 1, 3, 3R, 4, 4X, and 12 applications. The MD's key benefits are an extremely small footprint, a more economically efficient NEMA 4X solution, and a handle interlock preventing cover removal when the switch is in the ON position.

Switch features:

- Suitable for NEMA 1, 3R, 4, 4X, and 12 enclosure applications.
- Complies with OSHA lockout/tagout requirements—accepts up to three 8 mm padlocks.
- For accessories, see [Table 8.20](#).

**Table 8.26: MD Motor Disconnect Switch—Non-Metallic NEMA 1, 3, 3R, 4, 4X, and 12 Enclosure**

Amperes	Cat. No.	Maximum Horsepower Ratings			Height (in.)	Width (in.)	Depth (in.)
		Three-Phase Vac					
		220–240	440–480	600			
30	MD3304X	7.5	20	25	6.38	3.9	4.37
60	MD3604X	20	40	40	8.27	4.94	4.37

**Table 8.27: MD Motor Disconnect Accessories**

Cat. No.	Description
MDSAN20	2 N.O. auxiliary contact module
MDSAN11	1 N.O. and 1 N.C. auxiliary contact module
MDS30P	30 A add on power pole



*New!* **Disconnect Switches, 16–125 A**

Style	DIN Rail, Rear Mounting								Door Mounting								
	36 mm (1.42 in.)				70 mm (2.75 in.)				36 mm (1.42 in.)				70 mm (2.75 in.)				
<ul style="list-style-type: none"> <li>• Versions: DIN rail mounting, door mounting, and rear mounting</li> <li>• Wide range of accessories</li> <li>• Changeover switches</li> <li>• Conforming to UL 60947-4-1 (16–63 A) or UL 98 (63–125 A) specifications</li> </ul>																	
Ampere rating	16	25	32	40	63	63	80	100	125	16	25	32	40	63	80	100	125
Three pole	•	•	•	•	•	•	•	•	•	•	•	•	•	•	•	•	•
4th pole—simultaneous closing	•	•	•	•	•	•	•	•	•	•	•	•	•	•	•	•	•
4th pole—early-make closing	•	•	•	•	•	•	•	•	•	•	•	•	•	•	•	•	•
Fuse holder	•	•	•														
Mechanical 6-8 pole coupling system	•	•	•	•	•	•	•	•	•								
Mechanical interlock for line switching	•	•	•	•	•	•	•	•	•								

**Interpreting the Catalog Number**

Some combinations are not available. Use this table only for interpreting the catalog number.

**Table 8.28: Interpreting the Catalog Number**

<b>Example</b>	<b>VLS</b>	<b>3P</b>	<b>016</b>	<b>R</b>	<b>1</b>	
Description	Disconnect switch	1P = 1 pole 3P = 3 poles	016 = 16 A 025 = 25 A 032 = 32 A 040 = 40 A	063 = 63 A 080 = 80 A 100 = 100 A 125 = 125 A	D = Door mounting R = DIN rail mounting	1 = Small size (16–63 A), UL 508 2 = Large size (63–125 A), UL 98
<b>Example</b>	<b>VLSH</b>	<b>2</b>	<b>S</b>	<b>5</b>	<b>R</b>	
Description	Rotary handle	1 = Recessed, 65 x 65 mm 2 = Protruding, 65 x 65 mm 3 = Pistol grip, 75 mm dia. 4 = Protruding, 48 x 48 mm	H = Hole fixing S = Screw mounting	5 = 5 mm shaft opening 7 = 7 mm shaft opening	B = Black BC = Black, changeover BD = Black, defeatable R = Red RD = Red, defeatable	
<b>Example</b>	<b>VLSS</b>	<b>150</b>	<b>5</b>			
Description	Shafts	Length: 150–500 mm	Cross-section: 5 = 5 mm 7 = 7 mm			
<b>Example</b>	<b>VLS</b>	<b>1P</b>	<b>040</b>	<b>R</b>	<b>1</b>	<b>S</b>
Description	Additional Poles	Number of Poles: 1P = 1 Pole	Current: 016 = 16 A to 125 = 125 A	Mounting: R = DIN rail mounted D = Door mounted	Body Size: 1 = Small size (16–63 A) 2 = Large size (63–125 A)	Closing: S = Simultaneous closing E = Early Make closing
<b>Example</b>	<b>VLS</b>	<b>1N</b>	<b>R</b>		<b>1</b>	
Description	Ground and Neutral Terminals	1G = 1 Pole Ground terminal 1N = 1 Pole Neutral terminal	R = DIN rail mounted D = Door mounted		1 = Small size (16–63 A), UL 508 2 = Large size (63–125 A), UL 98	
<b>Example</b>	<b>VLS</b>	<b>A</b>	<b>11</b>	<b>R</b>	<b>1</b>	<b>S</b>
Description	Auxiliary contacts	A = Auxiliary contact	10 = 1 N.O. 11 = 1 N.O. + 1 N.C.	R = DIN rail mounted D = Door mounted	Blank = Size 1 and 2 1 = Size 1 2 = Size 2	S = Simultaneous closing E = Early make closing



VLS3P016R1–  
VLS3P063R1



**Product Overview**

**Compact Size**

The three-pole 16–63 A disconnect switches are made up of a single unit body, a mere 36 mm (1.4 in.) wide, while those rated 63–125 A are only 70 mm (2.8 in.) wide.

**Accessory Flexibility**

Mounting and removal of the fourth pole and add-on blocks are simple and quick operations with no need for tools.

**Certifications**

All VLS disconnect switches are certified by cCSAus and are UL Listed for Canada and USA:

- 16–63 A types: certified according to UL 60947-4-1 / CSA 22.2 n° 60947-4-1-14 standards
- 63–125 A types: certified according to UL 98 / CSA 22.2 n° 4 standards

**Three-Pole Disconnect Switches**

**Table 8.29: Certifications and Compliance (● = certification obtained)**

Catalog number	cULus per UL 60947-4-1 / CSA C22.2 n° 60947-4-1-14 UL Listed (File E487906)	cULus per UL 98 / CSA C22.2 n° 4 UL Listed (File E487907)	IEC/EN 60947-1, IEC/EN 60947-3
VLS3P016R1– VLS3P040R1	●	—	Compliant
VLS3P063R1	●	—	
VLS3P016D1– VLS3P040D1	●	—	
VLS3P063R2– VLS3P125R2	—	●	
VLS3P063D2– VLS3P125D2	—	●	



VLS3P063R2–  
VLS3P125R2



VLS3P016D1–  
VLS3P040D1



VLS3P063D2–  
VLS3P125D2

**Table 8.30: Selection—Three-Pole Disconnect Switches**

Catalog number	IEC conventional free air thermal current (I <sub>th</sub> ), AC21A (≤690 V) (A)	IEC rated operational current (I <sub>e</sub> ) AC22A (≤690 V), AC23A (≤415 V) (A)	UL general use at 600 Vac (A)
DIN rail mounting version, complete with black handle. For rear-mounting version, separately purchase the handle and shaft extension. Refer to page 8-16 and page 8-18.			
VLS3P016R1	16	16	16
VLS3P025R1	25	25	25
VLS3P032R1	32	32	32
VLS3P040R1	40	40	40
VLS3P063R1	63	45	60
VLS3P063R2	63	63	60
VLS3P080R2	80	80	100
VLS3P100R2	100	100	100
VLS3P125R2	125	125	100
Door-mounting version (no shaft required). Separately purchase the handle. Refer to page 8-16.			
VLS3P016D1	16	16	16
VLS3P025D1	25	25	25
VLS3P032D1	32	32	32
VLS3P040D1	40	40	40
VLS3P063D2	63	63	60
VLS3P080D2	80	80	100
VLS3P100D2	100	100	100
VLS3P125D2	125	125	100

Strokes of VLS switch poles

	Travel 0 → 1	0°	30°	60°	90°
VLS3P016R1–VLS3P063R1				60°	
VLS3P016D1–VLS3P040D1				60°	
VLS3P063R2–VLS3P125R2			55°		
VLS3P063D2–VLS3P125D2			55°		
	Off				On

**Table 8.31: UL / CSA Ratings**

Catalog number	Horsepower						General use at 600 Vac (A)	Short-circuit rating at 600 Vac (kA)	Max. fuse rating at 600 V (A)
	1 phase		3 phase						
	120 V	240 V	200–208 V	240 V	480 V	600 V			
UL 60947-4-1 and CSA 22.2 n° 60947-4-1-14 [1]									
VLS3P016**	1	2	5	5	10	10	16	5	30 (Type RK5)
VLS3P025**	1.5	3	7.5	7.5	15	20	25	5	30 (Type RK5)
VLS3P032**	2	5	10	10	20	20	32	5	45 (Type RK5)
VLS3P040**	2	5	10	15	20	25	40	5	45 (Type RK5)
VLS3P063R1	2	7.5	10	15	30	30	60	5	45 (Type RK5)
UL 98 and CSA C22.2 n° 4 [2]									
VLS3P063**	3	7.5	20 [3]	20	40	40	60	50	60
VLS3P080**	3	10	25 [3]	25	40	40	100	50	100
VLS3P100**	5	10	30 [3]	30	50	50	100	50	100
VLS3P125**	7.5	10	30 [3]	30	60	60	100	50	100

[1] Ratings are valid for VLS3P\*\*\*R\* and VLS3P\*\*\*D\* types, according to UL 60947-4-1 and CSA 22.2 n° 60947-4-1-14. UL Listed for USA and Canada (cULus - File E487907) as Manual Motor Controllers, while the UL designation is "General Purpose Switch. Interrupteur Usage General" and "Suitable As Motor Disconnect."

[2] Ratings are valid for VLS3P\*\*\*R\* and VLS3P\*\*\*D\* types, according to UL 98 and CSA C22.2 n° 4. UL Listed for USA and Canada (cULus - File E487907) as Open Type Switches – Open type unfused switch, while UL designation is "General Purpose Switch. Interrupteur Usage General."

[3] Voltage value is not considered in UL98 / CSA 22.2 n° 4 standards, and so is not indicated in the UL product marking.



VLS1P\*\*\*R•S  
VLS1P\*\*\*R•E



VLS1P040D1S  
VLS1P040D1E

Strokes of VLS poles (switch and add-on pole)

	Travel 0→1			
	0°	30°	60°	90°
VLS3P016R1/D1-VLS3P040R1/D1, VLS3P063R1 Main poles			60°	
VLS1P040R1S-VLS1P063R1S Simultaneous fourth-pole add on			60°	
VLS1P040R1E/D1E, VLS1P063R1E Early-make fourth-pole add on			55°	
VLS3P063R2/D2-VLS3P125R2/D2 Main poles			55°	
VLS1P063R2S/D2S-VLS1P125R2S/D2S Simultaneous fourth-pole add on			55°	
VLS1P125R2E/D2E Early-make fourth-pole add on			48°	

Off On

### Fourth Pole Add-on

Table 8.32: General Specifications—Fourth Pole Add-on

IEC ampere ratings	16–125 A
Available versions	DIN rail mounting Door mounting Simultaneous closing with switch poles Early-make closing with respect to switch poles
Size	Compact and modular

Table 8.33: Selection—Fourth Pole Add-on

Catalog number	IEC conventional free air thermal current Ith AC21A (≤690V) (A)	IEC rated operational current Ie AC22A (≤690V), AC23A (≤415V) (A)
Simultaneous closing operation with respect to switch poles		
DIN Rail Mounting (VLS3P***R•)		
VLS1P040R1S [4]	40	40
VLS1P063R1S [5]	63	45
VLS1P063R2S	63	63
VLS1P080R2S	80	80
VLS1P100R2S	100	100
VLS1P125R2S	125	125
Door Mounting (VLS3P***D•)		
VLS1P040D1S [6]	40	40
VLS1P063D2S	63	63
VLS1P080D2S	80	80
VLS1P100D2S	100	100
VLS1P125D2S	125	125
Early-make closing operation with respect to switch poles		
DIN Rail Mounting (VLS3P***R•)		
VLS1P040R1E [4]	40	40
VLS1P063R1E [6]	63	45
VLS1P125R2E [7]	125	125
Door Mounting (VLS3P***D•)		
VLS1P040D1E [6]	40	40
VLS1P125D2E [8]	125	125

**NOTE:** For Fourth Pole UL / CSA ratings, see page 8-10—they are the same as the ratings for the corresponding single-phase contact switch.

Table 8.34: Certifications and Compliance for Fourth Pole Add-on Blocks (• = certification obtained)

Catalog number	Certification Standard		IEC/EN 60947-1, IEC/EN 60947-3
	cULus per UL 60947-4-1 / CSA C22.2 n° 60947-4-1-14 / UL Listed (File E487906)	cULus per UL 98 / CSA C22.2 n° 4 / UL Listed (File E487907)	
VLS1P040R1E, VLS1P040R1S	•	—	Compliant
VLS1P063R1E, VLS1P063R1S	•	—	
VLS1P040D1E, VLS1P040D1S	•	—	
VLS1P125R2E, VLS1P125D2E	—	•	
VLS1P063R2S-VLS1P125R2S	—	•	
VLS1P063D2S-VLS1P125D2S	—	•	

[4] For VLS3P016R1–040R1 only.  
 [5] For VLS3P063R1 only.  
 [6] For VLS3P016D1–040D1 only.  
 [7] For VLS3P063R2–125R2 only.  
 [8] For VLS3P063D2–125D2 only.

Refer to Catalog 9400CT1601

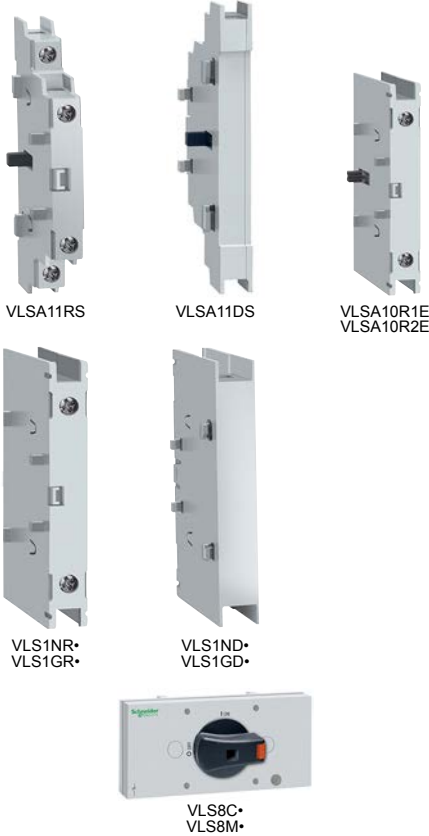

**Add-on Blocks**

**Table 8.35: Operational Specifications**

Auxiliary contacts		
IEC conventional free air thermal current (Ith)	10 A	
UL/CSA and IEC/EN 60947-5-1 designation	A600-Q600	
Tightening torque	0.8 N•m (7.1 lb-in.)	
Other devices		
Tightening torque	VLS1NR1/D1, VLS1GR1/D1 terminals	1.8–2 N•m (16–18 lb-in)
	VLS1NR2/D2, VLS1GR2/D2 terminals	5–6 N•m (45–54 lb-in)
	VLS8C1/C2, VLS8M1/M2	mounting: 0.5 N•m (4.4 lb-in) extension with handle: 0.8 N•m (7.1 lb-in)

**Table 8.36: Selection—Add-on Blocks**

Catalog number	Specifications
Auxiliary contacts, simultaneous operation with respect to switch poles	
VLSA11RS	1NO+1NC for VLS3P***R* and VLS3P063R1
VLSA11DS	1NO+1NC for VLS3P***D*
Auxiliary contacts, early-break operation with respect to switch poles	
VLSA10R1E	1EB (NO) for VLS3P016R1–VLS3P040R1, VLS3P063R1
VLSA10R2E	1EB (NO) for VLS3P063R2–VLS3P125R2
Neutral terminal	
VLS1NR1	For VLS3P016R1–VLS3P040R1, VLS3P063R1
VLS1NR2	For VLS3P063R2–VLS3P125R2
VLS1ND1	For VLS3P016D1–VLS3P040D1
VLS1ND2	For VLS3P063D2–VLS3P125D2
Earth/Ground terminal	
VLS1GR1	For VLS3P016R1–VLS3P040R1, VLS3P063R1
VLS1GR2	For VLS3P063R2–VLS3P125R2
VLS1GD1	For VLS3P016D1–VLS3P040D1
VLS1GD2	For VLS3P063D2–VLS3P125D2
Mechanical interlock for line changeover (I-0-II)	
VLS8C1	For VLS3P016R1–VLS3P040R1, VLS3P063R1, and VLSH2S5BC: □ 5 mm (0.2 in.) [9]
VLS8C2	For VLS3P063R2–VLS3P125R2 and VLSH2S5BC: □ 5 mm (0.2 in.) [9]
Mechanical coupling system for 6-8 pole disconnect switches	
VLS8M1	For VLS3P016R1–VLS3P040R1 and VLS3P063R1: □ 5 mm (0.2 in.) [9]
VLS8M2	For VLS3P063R2–VLS3P125R2: □ 7 mm (0.3 in.) [10]

Strokes of VLS poles (switch with auxiliary contact blocks)

	Travel 0 → 1	0°	30°	60°	90°
VLS3P016R1/D1, VLS3P040R1/D1, VLS3P063R1				60°	
Main poles					
VLSA11RS/DS				60°	
Auxiliary contacts (1 NO + 1 NC)	NO				
	NC				
VLSA10R1E			40°		
Auxiliary contact		Travel 0 → 1	60°		
(1EB – NO early break)		Travel 1 → 0	70°		
VLS3P063R2/D2...VLS3P125R2/D2				55°	
Main poles					
VLSA11RS/DS				45°	
Auxiliary contacts (1 NO + 1 NC)	NO				
	NC				
VLSA10R2E			25°		
Auxiliary contact		Travel 0 → 1	55°		
(1EB – NO early break)		Travel 1 → 0	65°		
		Off			On

[9] Use VLSS shaft extensions.

[10] Use VLSH3S7RD handles and VLSS\*\*\*7 extensions for a rear-mounting version.

**Sequence and Maximum Combination of Add-on Blocks  
DIN Rail Mounting Disconnect Switches**

**Table 8.37: VLS3P016R1–VLS3P040R1 (DIN Rail Mounting)**

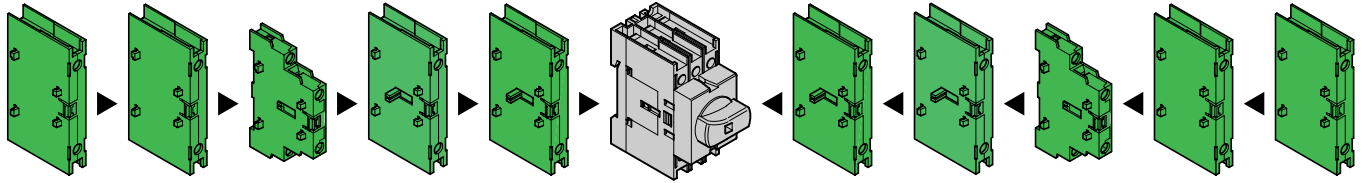

VLS1NR1	VLS1GR1	VLSA11RS	VLSA10R1E	VLS1P040R1E VLS1P040R1S	VLS3P016R1 VLS3P025R1 VLS3P032R1 VLS3P040R1	VLS1P040R1E VLS1P040R1S	VLSA10R1E	VLSA11RS	VLS1GR1	VLS1NR1
1	1	1	—	1	—	—	—	2	1	1
1	1	2	—	—	—	—	—	1	1	1
1	1	1	—	1	—	—	1	1	1	1
1	1	1	1	—	—	—	—	1	1	1
1	1	1	1	—	—	—	—	2	1	1
1	1	2	—	—	—	—	1	1	1	1
1	1	2	—	—	—	—	—	2	1	1
1	1	—	—	—	—	—	—	—	1	1
1	1	—	—	1	—	—	—	—	1	1
1	1	—	—	—	—	—	—	—	1	1

**Table 8.38: VLS3P063R1 (DIN Rail Mounting)**

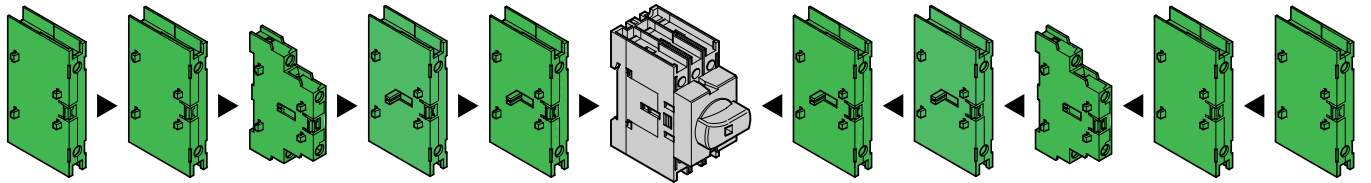

VLS1NR1	VLS1GR1	VLSA11RS	VLSA10R1E	VLS1P063R1E VLS1P063R1S	VLS3P063R1	VLS1P063R1E VLS1P063R1S	VLSA10R1E	VLSA11RS	VLS1GR1	VLS1NR1
1	1	1	—	1	—	—	—	2	1	1
1	1	2	—	—	—	1	—	1	1	1
1	1	1	—	1	—	—	1	1	1	1
1	1	1	1	—	—	1	—	1	1	1
1	1	1	1	—	—	—	—	2	1	1
1	1	2	—	—	—	—	1	1	1	1
1	1	2	—	—	—	—	—	2	1	1
1	1	—	—	—	—	1	—	—	1	1
1	1	—	—	1	—	—	—	—	1	1
1	1	—	—	—	—	—	—	—	1	1

**Table 8.39: VLS3P063R2–VLS3P125R2 (DIN Rail Mounting)**

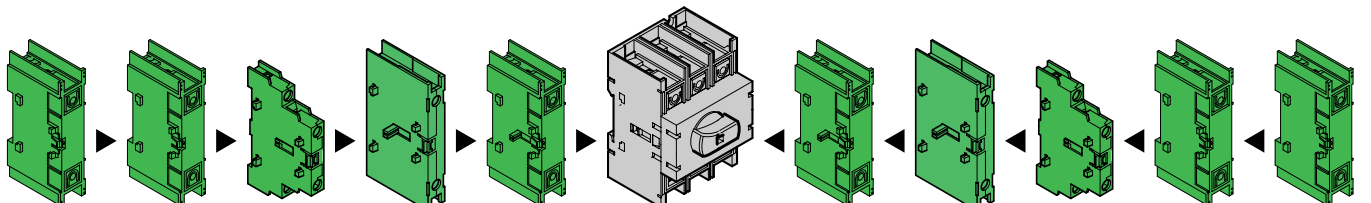

VLS1NR2	VLS1GR2	VLSA11RS	VLSA10R2E	VLS1P125R2E VLS1P***R•S	VLS3P063R2 VLS3P080R2 VLS3P100R2 VLS3P125R2	VLS1P125R2E VLS1P***R•S	VLSA10R2E	VLSA11RS	VLS1GR2	VLS1NR2
—	—	1	—	1	—	—	—	2	—	—
—	—	2	—	—	—	1	—	1	—	—
—	—	1	—	1	—	—	1	1	—	—
—	—	1	1	—	—	1	—	1	—	—
—	—	1	1	—	—	—	—	2	—	—
—	—	2	—	—	—	—	1	1	—	—
—	—	2	—	—	—	—	—	2	—	—
1	1	—	—	—	—	1	—	—	1	1
1	1	—	—	1	—	—	—	—	1	1
1	1	—	—	—	—	—	—	—	1	1

Door Mounting Disconnect Switches

Table 8.40: VLS3P016D1–VLS3P040D1 (Door Mounting)

VLS1ND1	VLS1GD1	VLSA11DS	VLS1P040D1E VLS1P040D1S	VLS3P016D1 VLS3P025D1 VLS3P032D1 VLS3P040D1	VLS1P040D1E VLS1P040D1S	VLSA11DS	VLS1GD1	VLS1ND1
1	1	1	1					1
1	1	1	—		1	1	1	1
1	1	—	1		—	1	1	1
1	1	1	—		1	—	1	1
1	1	1	—		—	1	1	1
1	1	—	—		—	1	1	1
1	1	—	—		—	—	1	1

Table 8.41: VLS3P063D2–VLS3P125D2 (Door Mounting)

VLS1ND2	VLS1GD2	VLSA11DS	VLS1P125D2E VLS1P125D2S	VLS3P063D2 VLS3P080D2 VLS3P100D2 VLS3P125D2	VLS1P125D2E VLS1P125D2S	VLSA11DS	VLS1GD2	VLS1ND2
—	—	1	1		—	1	—	—
—	—	1	—		1	—	—	—
1	1	—	1		—	1	—	—
—	—	1	—		1	—	1	1
—	—	1	—		—	1	—	—
1	1	—	—		—	—	1	1

**Mechanical Coupling and Mechanical Interlock for Line Changeover**

**Table 8.42: VLS3P016R1–VLS3P040R1, VLS8C1–VLS8M1 (Rear Mounting)**

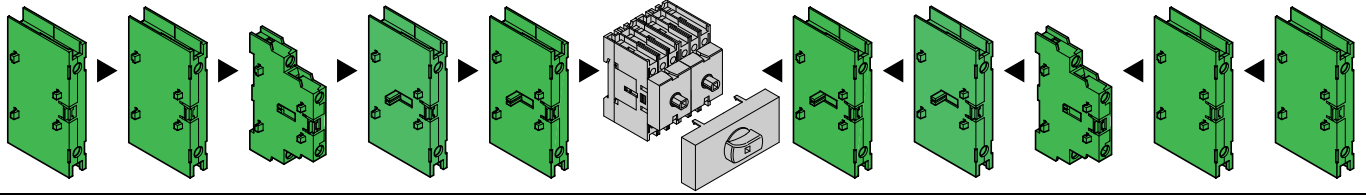

VLS1NR1	VLS1GR1	VLSA11RS	VLSA10R1E	VLS1P040R1E VLS1P040R1S	VLS8C1–VLS8M1	VLS1P040R1E VLS1P040R1S	VLSA10R1E	VLSA11RS	VLS1GR1	VLS1NR1
1	1	1	—	1	VLS3P016R1 +	1	—	1	1	1
1	1	1	—	1	VLS3P016R1	—	—	2	1	1
1	1	2	—	—	VLS3P025R1 +	1	—	1	1	1
1	1	1	—	1	VLS3P025R1	—	1	1	1	1
1	1	1	1	—	VLS3P032R1 +	1	—	1	1	1
1	1	1	1	—	VLS3P032R1	—	1	1	1	1
1	1	1	—	—	VLS3P040R1 +	—	—	2	1	1
1	1	2	—	—	VLS3P040R1	—	1	1	1	1
1	1	2	—	—	—	—	—	2	1	1
1	1	—	—	1	—	1	—	—	1	1
1	1	—	—	—	—	—	—	—	1	1
1	1	—	—	—	—	—	—	—	1	1

**Table 8.43: VLS3P063R1 + VLS8C1–VLS8M1 (Rear Mounting)**

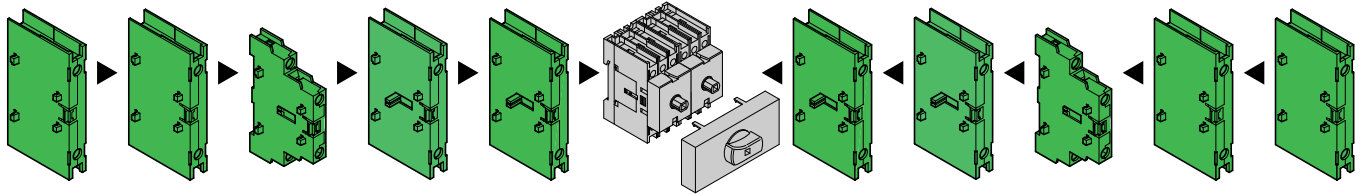

VLS1NR1	VLS1GR1	VLSA11RS	VLSA10R1E	VLS1P063R1E VLS1P063R1S	VLS8C1– VLS8M1	VLS1P063R1E VLS1P063R1S	VLSA10R1E	VLSA11RS	VLS1GR1	VLS1NR1
1	1	1	—	1	VLS3P063R1 +	1	—	1	1	1
1	1	1	—	1	VLS3P063R1	—	—	2	1	1
1	1	2	—	—	—	1	—	1	1	1
1	1	1	—	1	—	—	1	1	1	1
1	1	1	1	—	—	1	—	1	1	1
1	1	1	1	—	—	—	—	2	1	1
1	1	2	—	—	—	—	1	1	1	1
1	1	2	—	—	—	—	—	2	1	1
1	1	—	—	1	—	1	—	—	1	1
1	1	—	—	—	—	—	—	—	1	1

**Table 8.44: VLS3P063R2–VLS3P125R2 + VLS8C2–VLS8M2 (Rear Mounting)**

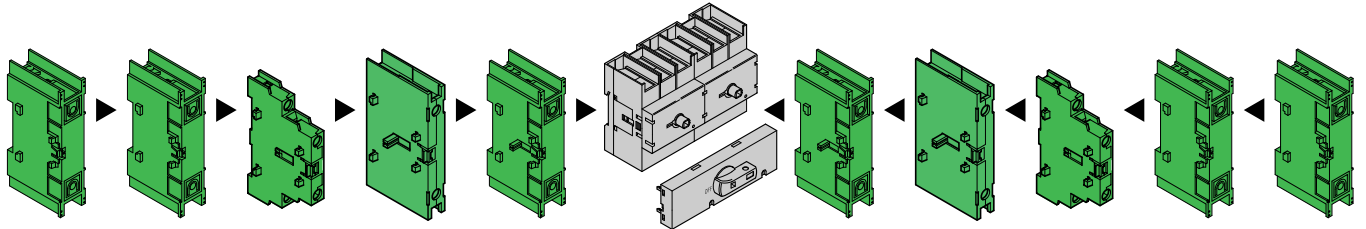

VLS1NR2	VLS1GR2	VLSA11RS	VLSA10R2E	VLS1P125R2E VLS1P***R-S	VLS8C2 - VLS8M2	VLS1P125R2E VLS1P***R-S	VLSA10R2E	VLSA11RS	VLS1GR2	VLS1NR2
—	—	1	—	1	VLS3P063R2 +	1	—	1	—	—
—	—	1	—	1	VLS3P063R2	—	—	2	—	—
—	—	2	—	—	VLS3P080R2 +	1	—	1	—	—
—	—	1	—	1	VLS3P080R2	—	1	1	—	—
—	—	1	1	—	VLS3P100R2 +	1	—	1	—	—
—	—	1	1	—	VLS3P100R2	—	—	2	—	—
—	—	2	—	—	VLS3P125R2 +	—	1	1	—	—
—	—	2	—	—	VLS3P125R2	—	—	2	—	—
1	1	—	—	1	—	1	—	—	1	1
1	1	—	—	—	—	—	—	—	1	1

Refer to Catalog 9400CT1601



Rotary Handles

Table 8.45: Selection—Rotary Handles (NEMA 1, 12, 3R, 4, and 4X. IEC IP65 unless otherwise specified)

Catalog number	Specifications
<b>Door Mounting and Rear Mounting Handles, Padlock-ready<sup>[11]</sup></b>	
<b>Red/yellow, rotating</b>	
VLSH1S5R	For VLS3P***R and VLS3P***D. Screw mounting. Recessed selector. □ 5 mm (0.2 in.). <sup>[12]</sup>
VLSH2S5R	For VLS3P***R and VLS3P***D. Screw mounting. Protruding selector. □ 5 mm (0.2 in.). <sup>[12]</sup>
VLSH2H5R	For VLS3P***R and VLS3P016D1–VLS3P040D1. Ring mounting. Protruding selector. □ 5 mm (0.2 in.). <sup>[12] [13]</sup>
VLSH2H5RD	For VLS3P***R. Ring mounting. Protruding selector with release, defeatable per UL60947-4-1; □ 5 mm (0.2 in.). <sup>[12]</sup>
VLSH2H5RL	For VLS3P***R, VLS3P063R1, VLS3P016D1–VLS3P040D1. Ring mounting. Low-profile protruding selector, □ 5 mm (0.2 in.).
VLSH3S7RD	For VLS3P063R2–VLS3P125R2, and VLS8M2. Screw mounting. Pistol grip with release, defeatable per 60947-4-1; □ 7 mm (0.3 in.). IEC IP66. <sup>[14]</sup>
VLSH4S5R	For For VLS3P***R and VLS3P***D. Screw mounting. Protruding selector. 48 mm square. □ 5 mm (0.2 in.). <sup>[12]</sup>
<b>Black, rotating</b>	
VLSH1S5B	For VLS3P***R and VLS3P***D. Screw mounting. Recessed selector. □ 5 mm (0.2 in.). <sup>[12]</sup>
VLSH2S5B	For VLS3P***R and VLS3P***D. Screw mounting. Protruding selector. □ 5 mm (0.2 in.). <sup>[12]</sup>
VLSH2H5B	For VLS3P***R, VLS3P063R1, VLS3P016D1–VLS3P040D1. Ring mounting. Protruding selector. □ 5 mm (0.2 in.). <sup>[12] [13]</sup>
VLSH2H5BD	For VLS3P***R. Ring mounting. Protruding selector with release, defeatable per 60947-4-1. □ 5 mm (0.2 in.). <sup>[12]</sup>
VLSH2H5BL	For VLS3P***R, VLS3P063R1, VLS3P016D1–VLS3P040D1. Ring mounting. Low profile protruding selector, □ 5 mm (0.2 in.).
VLSH2H5BPO	For VLS3P***R, VLS3P063R1, VLS3P016D1–VLS3P040D1. Ring mounting. Lock On protruding selector, □ 5 mm (0.2 in.).
VLSH3S7BD	For VLS3P063R2–VLS3P125R2, and VLS8M2. Screw mounting. Pistol grip with release, defeatable per UL60947-4-1; □ 7 mm (0.3 in.). <sup>[14]</sup>
VLSH2S5BC	For VLS8C mechanical interlock mechanism (I-O-II). □ 5 mm (0.2 in.). <sup>[12]</sup>
VLSH4S5B	For For VLS3P***R and VLS3P***D. Screw mounting. Protruding selector. □ 5 mm (0.2 in.). <sup>[12]</sup>
<b>Accessories for Rear Mounting Control For VLSH3S7RD and VLSH3S7BD handles.</b>	
VLSHA7	Adapter, □ 7 mm (0.3 in.) for VLS3P063R2–VLS3P125R2.

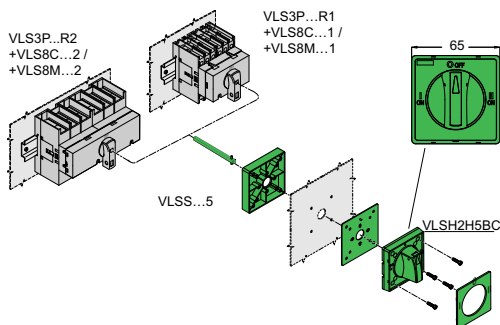

Figure 8.1: Transformation of the DIN rail mounting version into the rear mounting version

Table 8.46: Certifications and Compliance (● = certification obtained)

Catalog number	cULus per UL 60947-4-1 / CSA C22.2 n° 60947-4-1-14 UL Listed (File E487906)	cULus per UL 98 / CSA C22.2 n° 4 UL Listed (File E487907)
VLSA11RS/DS	—	—
VLSA10R1E	UL Listed, cULus File E478582	—
VLSA10R2E	CSA C22.2 n° 14-10	—
VLS1NR1/D1	●	●
VLS1NR2/D2	—	●
VLS1GR1/D1	●	—
VLS1GR2/D2	—	●
VLS8C1/M1	●	●
VLS8C2/M2	—	●
VLSH1S5R/B	●	●
VLSH2S5R/B	●	●
VLSH2H5R/B	●	●
VLSH2H5RL	●	●
VLSH2H5BL	●	●
VLSH2H5BPO	●	—
VLSH4S5R/B	●	●
VLSH2H5RD/BD	●	●
VLSH3S7RD/BD	—	●
VLSH2H5BC	—	●
VLSHA7	—	●

Compliant with standards: IEC/EN 60947-1, IEC/EN 60947-3, IEC/EN 60947-5-1, UL 60947-4-1, UL 98, CSA C22.2.

[11] Catalog numbers ending in BD or RD are for rear mounting units only.  
 [12] For VLS3P\*\*\*R disconnect switches, separately purchase VLSS shaft extensions.  
 [13] Snap-on mounting of VLS3P016–VLS3P040D1 disconnect switches with the handle.  
 [14] Separately purchase the VLSS...7 shaft extension and a VLSHA7 handle having a 7 mm (0.3 in.) square section—not required for VLS8M2.



Table 8.47: Operating Specifications

<b>Handle mounting</b>		ring or screw
<b>Mounting handle interaxis</b> (compatible with the pre-existing drillings of the most common types in the marketplace)	VLSH1S5R/B VLSH2S5R/B VLSH2S5BC	36 x 36 mm (1.4 x 1.4 in.) or 48 x 48 mm (1.9 x 1.9 in.)
	VLSH3S7RD/BD	36 x 36 mm (1.4 x 1.4 in.)
		1–3 for all handles Ø4–8 mm (Ø0.2–0.3 in.)
<b>Padlocks</b>		1–3 for all handles Ø4–8 mm (Ø0.2–0.3 in.)
<b>Tightening torque</b>	Mounting ring types	2.3 N•m (20.4 lb-in)
	VLS8M1	0.8 N•m (7 lb-in)
	VLSH3S7RD/BD	1.5 N•m (13.3 lb-in)
	All others	1 N•m (9 lb-in)
<b>Degree of protection</b>	IEC / EN: IP65 for all except VLSH3S7RD/BD, which are IP66. UL / CSA: VLSH1S5R/B and VLSH3S7RD/BD are Type 1, 12, 3R, 4, and 4X outdoor use with all VLS switch models. VLSH2S5R/B, VLSH2H5R/B, VLSH2H5RD/BD and VLSH2S5BC are Types 1, 12, 3R, 4, and 4X outdoor use with VLS3P016R1/D1–VLS3P040R1/D1 and VLS3P063R1 models, otherwise Type 1 only.	

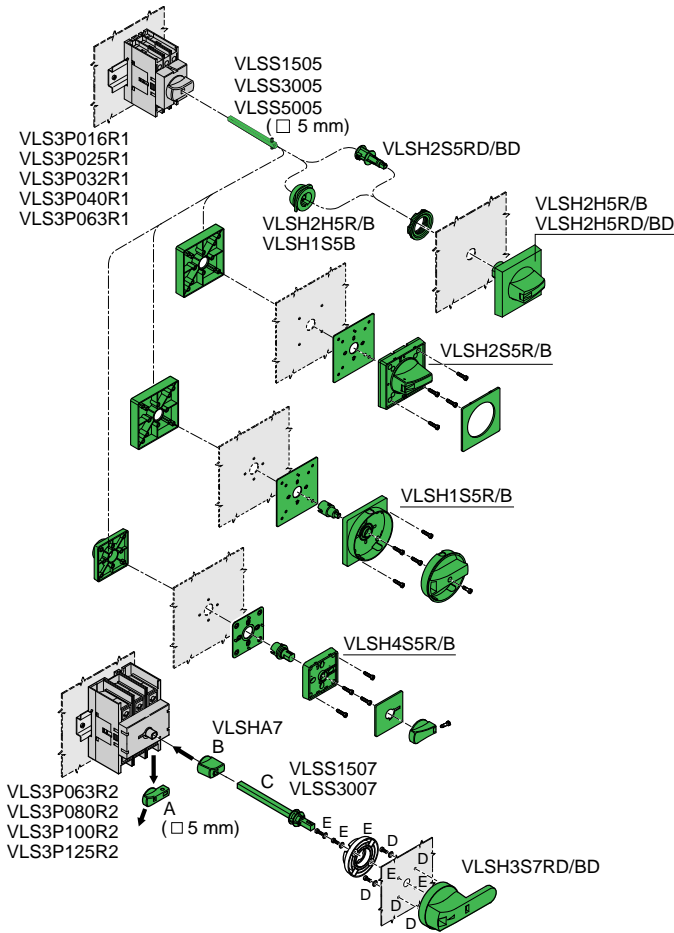

Figure 8.2: Changing the DIN rail mounting version for rear mounting

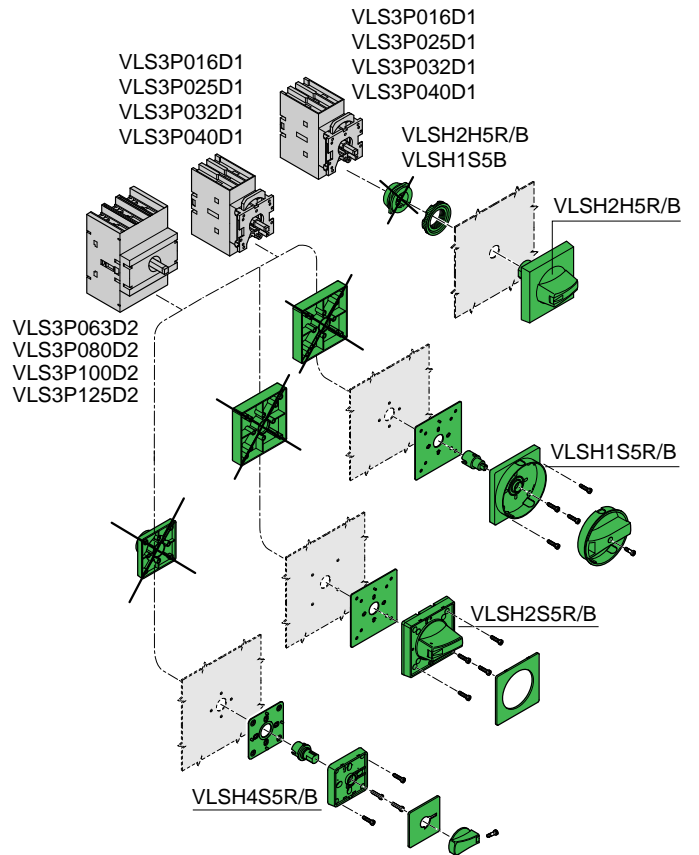

Figure 8.3: Door mounting version  
Certifications and Compliance:  
See Table 8.46 for details.

Refer to Catalog 9400CT1601

Shaft Extensions, Terminal Covers, Fuse Holders, and Fuse Blocks

Table 8.48: Selection—Shaft Extensions, Terminal Covers, Fuse Holders, and Fuse Blocks



Catalog number	Specifications	Qty per package	Weight, kg (lb)
Shaft extension for rear-mounting handles VLSH1S5R–VLSH2H5RD, VLSH1S5B–VLSH2H5BD, VLSH2S5BC; interlocking changeover type VLS8C1, VLS8C2; and mechanical disconnect switch system VLS8M1			
VLSS1505	150 mm long; □ 5 mm (0.2 in.)	1	0.032 (0.07)
VLSS3005	300 mm long; □ 5 mm (0.2 in.)	1	0.068 (0.15)
VLSS5005	500 mm long; □ 5 mm (0.2 in.)	1	0.090 (0.20)
Shaft extension for rear-mounting handles VLSH3S7RD/BD, and mechanical coupling system VLS8M2			
VLSS1507	150 mm long; □ 7 mm (0.3 in.)	1	0.090 (0.20)
VLSS3007	300 mm long; □ 7 mm (0.3 in.)	1	0.160 (0.35)
VLSS5007	500 mm long; □ 7 mm (0.3 in.)	1	0.250 (0.55)
VLS5S7	Support for □ 7 mm shaft	1	0.160 (0.35)
Set of 2 one-pole terminal covers for fourth pole			
VLSC1P1	For VLS1P040R1S, VLS1P040D1S, VLS1P040R1E, VLS1P040D1E, VLS1P063R1E, VLS1P063R1S	1	0.009 (0.02)
VLSC1P2	For VLS1P063R2S–VLS1P125R2S, VLS1P063D2S–VLS1P125D2S, VLS1P125R2E, VLS1P125D2E	1	0.012 (0.03)
Set of 2 three-pole terminal covers			
VLSC3P1	For VLS3P016R1–VLS3P040R1, VLS3P063R1, VLS3P016D1–VLS3P040D1	1	0.018 (0.04)
VLSC3P2	For VLS3P063R2–VLS3P125R2, VLS3P063D2–VLS3P125D2	1	0.030 (0.07)
Fuse holder/block for disconnect switches			
VLSFH1UL	For VLS3P016R1–VLS3P032R1 (suitable for Class CC fuses)	1	0.135 (0.30)

Table 8.49: Operational Specifications of Fuse Holder

IEC rated insulation voltage, U <sub>i</sub>	1000 V
IEC rated impulse withstand voltage, U <sub>imp</sub>	8 kV
<ul style="list-style-type: none"> <li>The fuse holder/block connects directly to the disconnect switches.</li> <li>Access to fuses only when the disconnect switches are in Off position.</li> </ul>	

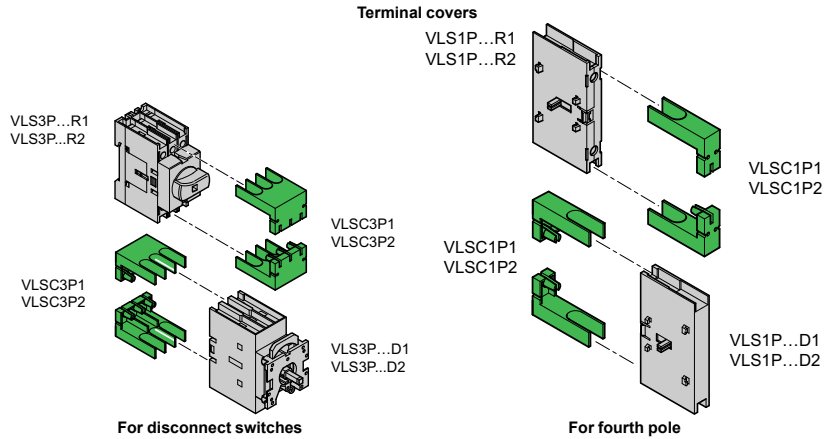
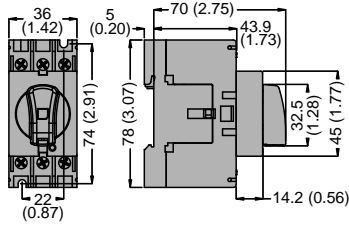

Table 8.50: Certifications and Compliance (● = certification obtained)

Catalog number	cULus per UL60947-4-1 / CSA C22.2 n° 60947-4-1-14 UL Listed (File E487906)	cULus per UL98 / CSA C22.2 n° 4 UL Listed (File E487907)
VLSS1505, VLSS3005, VLSS5005	●	—
VLSS1507, VLSS3007	●	—
VLSC1P1, VLSC3P1	—	—
VLSC1P2, VLSC3P2	—	—
VLSFH1UL	●	—
Compliant with standards: IEC/EN 60947-1, IEC/EN 60947-3, UL60947-4-1, UL98, CSA C22.2.		

**Table 8.51: DIN Rail Mounting Disconnect Switches**  
VLS3P016R1–VLS3P040R1, VLS3P063R1



VLS3P063R2–VLS3P125R2

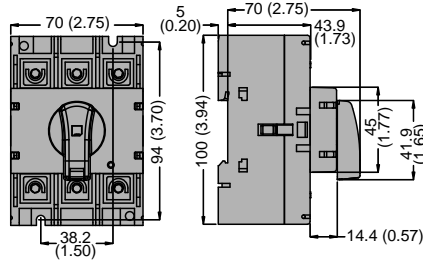

Dim. = mm (in.)

**Table 8.52: Door Mounting Disconnect Switches**  
VLS3P016D1–VLS3P040D1

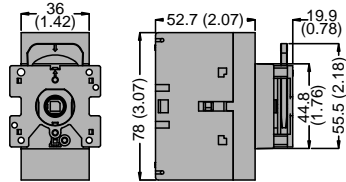

VLS3P063D2–VLS3P125D2

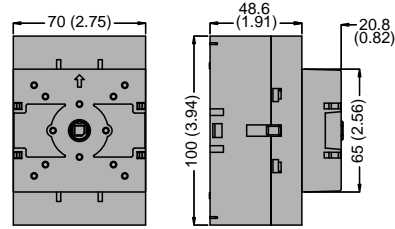

Dim. = mm (in.)

**Table 8.53: Add-on Blocks and Accessories**  
For VLS3P016R1–VLS3P040R1, VLS3P063R1

**Auxiliary contacts**  
VLSA11RS, VLSA10R1E

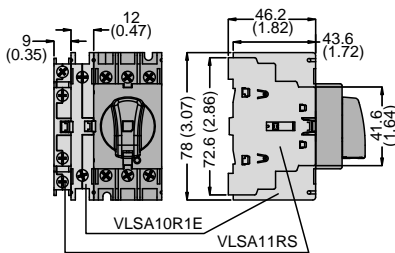

**Fourth pole**  
VLS1P040R1E/R1S, VLS1P063R1E/R1S  
VLS1NR1 neutral, VLS1GR1 ground terminals

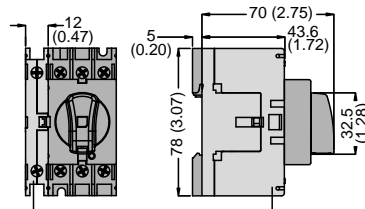

Dim. = mm (in.)

VLS3P016R1, VLS3P025R1, VLS3P032R1,  
VLS3P040R1, VLS3P063R1, VLSA11RS

For VLS3P063R2–VLS3P125R2

**Auxiliary contacts**  
VLSA11RS  
VLSA10R2E

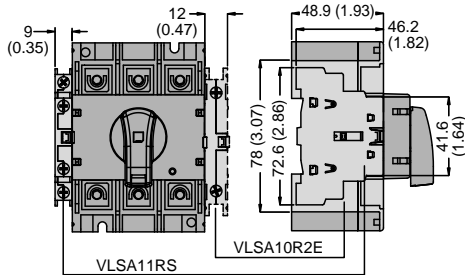

**Fourth pole**  
VLS1P125R2E, VLS1P063R2S–VLS1P125R2S  
VLS1NR2 neutral, VLS1GR2 ground terminals

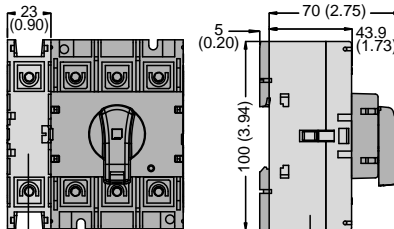

Dim. = mm (in.)

VLS3P063R2, VLS3P080R2, VLS3P100R2, VLS3P125R2,  
VLSA10R1E, VLSA10R2E, VLS1P063R2S, VLS1P080R2S,  
VLS1P100R2S, VLS1P125R2S, VLS1P125R2

**Mechanical interlock VLS8C1 and mechanical coupling system VLS8M1**

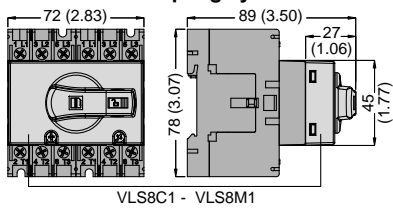

**Mechanical interlock VLS8C2 and mechanical coupling system VLS8M2**

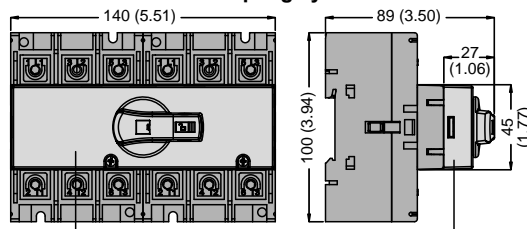

Dim. = mm (in.)

VLS8C2 - VLS8M2

For VLS3P016D1–VLS3P040D1

Auxiliary contacts  
VLSA11DS

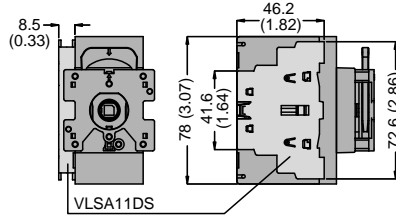

Fourth pole  
VLS1P040D1E–VLS1P040D1S  
VLS1ND1 neutral, VLS1GD1 ground terminals

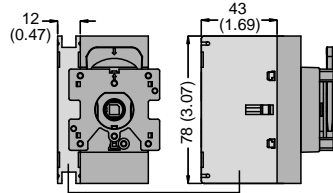

Dim. =  
mm (in.)

VLS3P016D1, VLS3P025D1, VLS3P032D1,  
VLS3P040D1, VLS1P040D1S, VLS1P040D1E

For VLS3P063D2–VLS3P125D2

Auxiliary contacts  
VLSA11DS

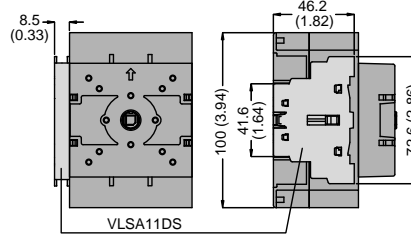

Fourth pole  
VLS1P125D2E, VLS1P063D2S–125D2S  
VLS1ND2 neutral, VLS1GD2 ground terminals

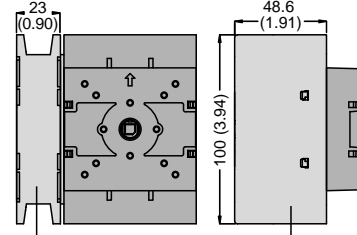

Dim. =  
mm (in.)

VLS1P063D2S, VLS1P080D2S, VLS1P100D2S,  
VLS1P125D2S, VLS1P125D2E, VLS1ND1,  
VLS1ND2, VLS1GD1, VLS1GD2

Table 8.54: Rotary handles

VLSH1S5R/B

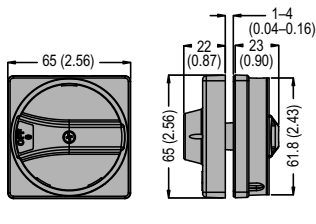

VLSH2S5R/B

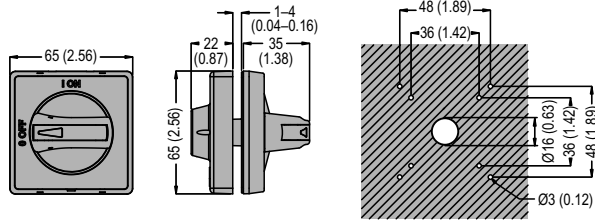

Dim. =  
mm (in.)

VLSH2H5R/B

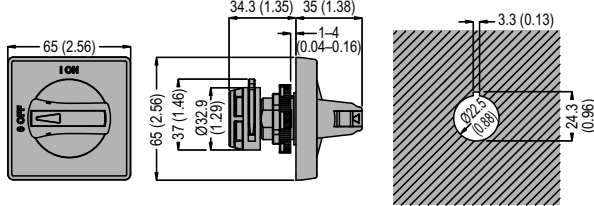

VLSH2H5RD/BD

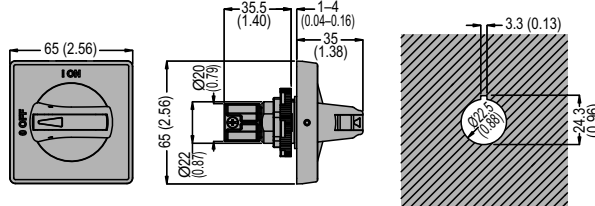

Dim. =  
mm (in.)

VLSH3S7RD/BD

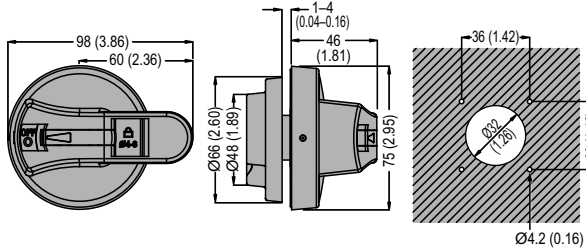

VLSH2S5BC

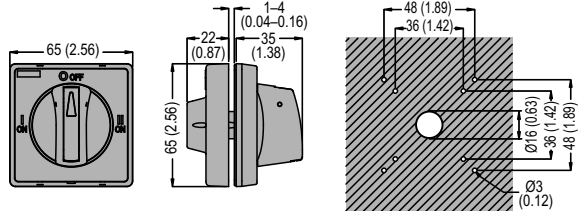

Dim. =  
mm (in.)

VLSH4S5R/B

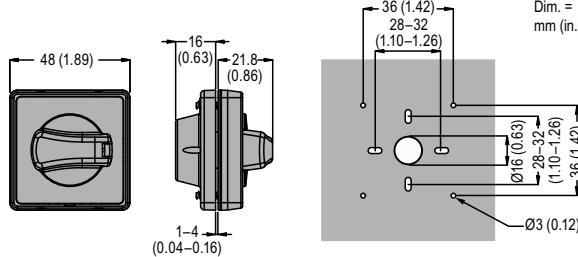

Dim. =  
mm (in.)

**Shaft extensions for rear-mounting handles (for Dimension A, see Table 8.55)**

VLSS

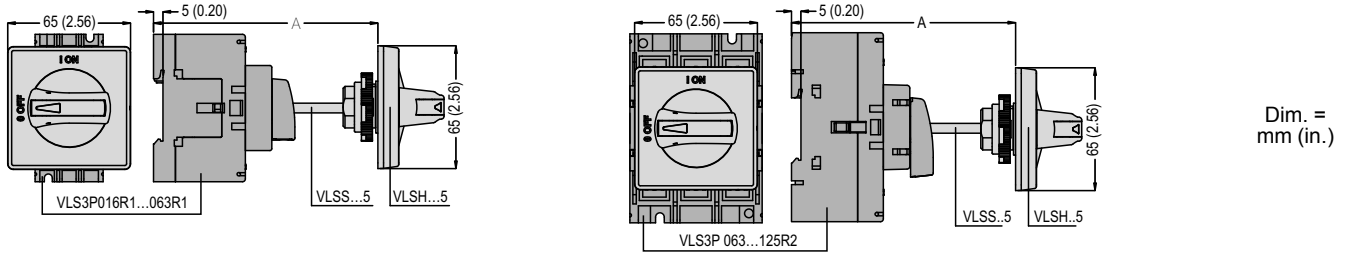

Dim. = mm (in.)

**Table 8.55: Dimension A for VLSS Shaft Extensions**

Dimension A for VLSS Shaft Extensions (see below)						
Extension	Length mm (in.)	Maximum Dimension A, mm (in.)				
		Type of handle				
		VLSH1S5*	VLSH2S5*	VLSH2H5R	VLSH2H5RD	VLSH2S5BC
VLSS1505	150 (5.90)	194 (7.64)	192 (7.56)	197 (7.75)	211 (8.31)	192 (7.56)
VLSS3005	300 (11.81)	344 (13.54)	342 (13.46)	347 (13.66)	361 (14.21)	342 (13.46)
VLSS5005	500 (19.68)	544 (21.42)	542 (21.34)	547 (21.53)	561 (22.09)	542 (21.34)

VLSS used with VLS8C1, VLS8C2, and VLS8M1

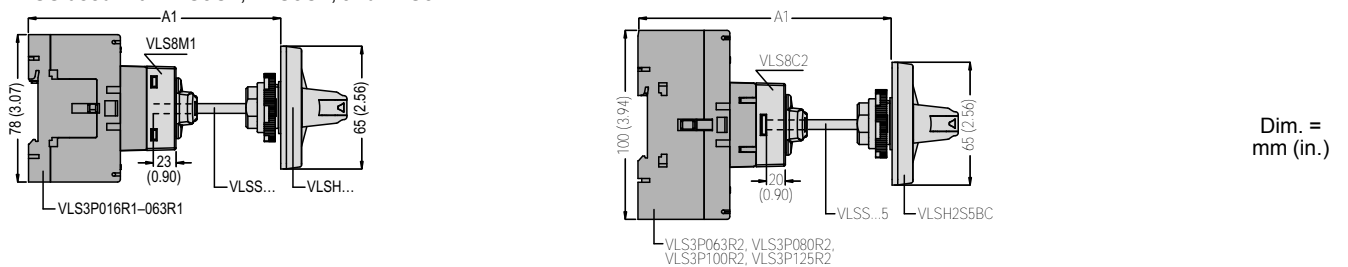

Dim. = mm (in.)

**Table 8.56: Dimension A1 for VLSS used with VLS8C1, VLS8C2, and VLS8M1**

Extension (5 mm)	Length mm (in.)	A1 maximum, mm (in.)				
		Used with VLS8M1		Used with VLS8C1/VLS8C2		
		Type of handle				
		VLSH1S5*	VLSH2S5*	VLSH2H5R	VLSH2H5RD	VLSH2S5BC
VLSS1505	150 (5.90)	211 (8.31)	209 (8.23)	214 (8.42)	228 (8.98)	209 (8.23)
VLSS3005	300 (11.81)	361 (14.21)	359 (14.13)	364 (14.33)	378 (14.88)	359 (14.13)
VLSS5005	500 (19.68)	561 (22.09)	559 (22.01)	564 (22.20)	578 (22.75)	559 (22.01)

VLSS...7 used with VLSHA7 and VLSH3S7RD/BD

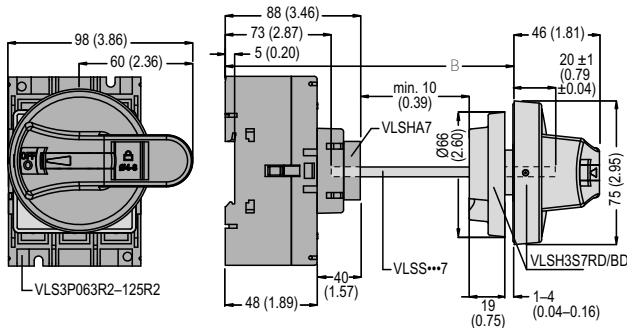

VLSS...7 used with VLS8M2 and VLSH3S7RD/BD handle

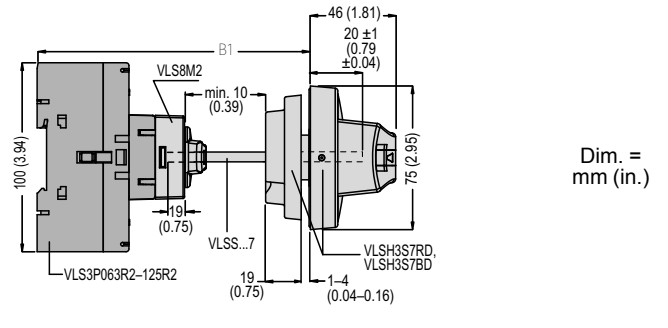

Dim. = mm (in.)

Extension (7 mm)	Length mm (in.)	B with VLSH3S7RD/BD handle	
		mm (in.)	B1 mm (in.)
VLSS1507	176 (6.93)	118–229 (4.64–9.01)	119–205 (4.68–8.07)
VLSS2007	226 (8.90)	118–279 (4.64–10.99)	119–255 (4.68–10.03)
VLSS3007	326 (12.83)	118–379 (4.64–14.92)	119–355 (4.68–13.98)

**Table 8.57: Terminal Cover and Fuse Holder Dimensions**

**Terminal Cover Dimensions**  
VLSC1P1, VLSC3P1

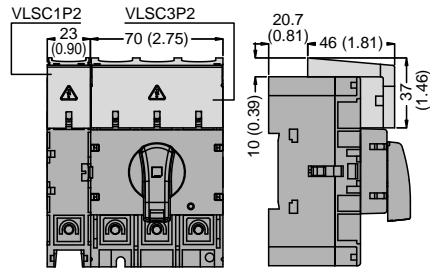
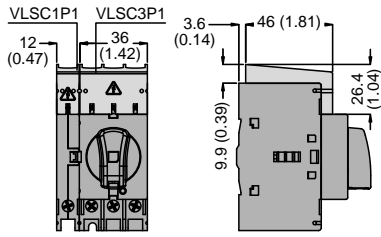

**Fuse Holder Dimensions**  
VLSFH1UL

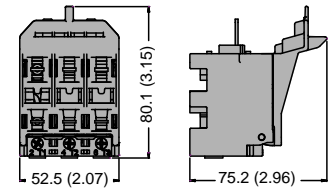

**VLSC1P2, VLSC3P2**

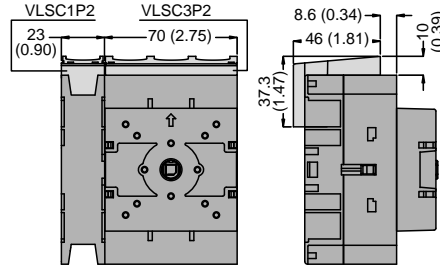
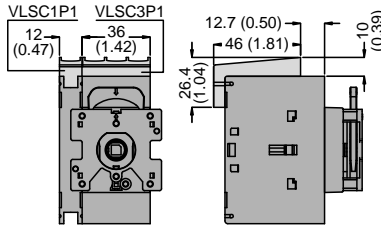

Dim. =  
mm (in.)

**Table 8.58: Wiring Diagrams—VLS Disconnect Switches (16–125 A)**

**Three-pole disconnectors**

VLS3P016... –  
VLS3P125R2/D2

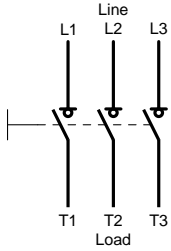

**Fourth pole add-on**  
VLS1P.....S



VLS1P.....E

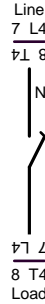

**Add-on Blocks and Accessories**

**Auxiliary contacts**

VLSA11-S

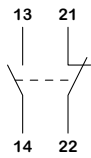

VLSA10R1E–VLSA10R2E



**Neutral terminal**

VLS1NR1/D1–VLS1NR2/D2



**Earth/Ground terminal**

VLS1GR1/D1–VLS1GR2/D2



**Fuse holder**

VLSFH1

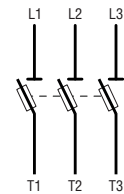

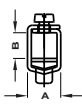
Model	3-pole: VLS3P...	016...	025...	032...	040...	063R1	063R2	080...	100...	125...	
	4th pole: VLS1P...	040...	040...	040...	040...	063R1S	063R2S	080...	100...	125...	
<b>Contact Specifications</b>											
IEC conventional free air thermal current, I <sub>th</sub> (≤40 °C)		A	16	25	32	40	63	63	80	100	125
IEC rated insulation voltage, U <sub>i</sub>		V	1000								
IEC rated impulse withstand voltage, U <sub>imp</sub>		kV	8								
<b>IEC rated operational current, I<sub>e</sub></b>											
AC21A	400 V	A	16	25	32	40	63	63	80	100	125
	500 V	A	16	25	32	40	63	63	80	100	125
	690 V	A	16	25	32	40	63	63	80	100	125
AC22A	400 V	A	16	25	32	40	45	63	80	100	125
	500 V	A	16	25	32	40	45	63	80	100	125
	690 V	A	16	25	32	40	45	63	80	100	125
AC23A	400 V	A	16	25	32	40	45	63	80	100	125
	500 V	A	16	25	25	25	25	63	63	80	100
	690 V	A	16	25	25	25	25	47	47	47	47
<b>IEC rated operational power</b>											
AC23A	400 V	kW	7.5	11	15	18.5	22	30	45	55	55
	690 V	kW	11	22	22	22	22	45	45	45	45
IEC reactive power for capacitor control 400 V		kvar	7.5	10	12.5	15	15	25	30	40	50
<b>IEC protection against short-circuit</b>											
Rated short-time withstand current (1 s), I <sub>cw</sub>		A rms	800								2500
Rated conditional short-circuit current		kA rms	50								
With fuse class gG		A	16	25	32	40	63	63	80	100	125
IEC making capacity (AC23A 400 V)		A	400				450	1250			
IEC breaking capacity (AC23A 400 V)		A	320				360	1000			
Mechanical life (depending on the application)		cycles	100,000				100,000	30,000			
Electrical life (IEC AC21A)		cycles	100,000				15,000	30,000			
UL/CSA general use at 600 V		A	16	25	32	40	50	60	100	100	100
UL/CSA short-circuit rating at 600 V		kA	5	5	5	5	5	50	50	50	50
UL/CSA fuse class/max rating at 600 V		Type/A	RK5/20	RK5/30	RK5/35	RK5/45	RK5/45	–/100	–/100	–/100	–/100
<b>UL/CSA Hp ratings</b>											
Single phase	120 V	hp	1	1.5	2	2	2	3	3	5	7.5
	240 V	hp	2	3	5	5	7.5	7.5	10	10	10
Three phase	200–208 V	hp	5	7.5	10	10	10	20	25	30	25
	240 V	hp	5	7.5	10	15	15	20	30	30	30
	480 V	hp	10	15	20	20	30	40	40	50	50
	600 V	hp	10	20	20	25	30	40	40	60	40
<b>Terminals</b>											
	Type	Lug clamp IEC/EN 60947-1 designation: Pillar terminal.									
	A	5.6 mm (0.22 in.)							12.4 mm (0.49 in.)		
	B	6.5 mm (0.26 in.)							10.4 mm (0.41 in.)		
	Screw	M4							M8		
	Tool	Phillips 2							Metric Allen key 4		
Tightening torque		N•m	1.8–2								5–6
		lb-in	16–18								45–54
Conductor section (solid/stranded)		mm <sup>2</sup>	0.75–16								4–50
		AWG	18–6								12–1
<b>Ambient Conditions</b>											
Temperature	Operating	°C	–25 to +55								
	Storage	°C	–40 to +70								
Maximum altitude		m	3000								
Mounting position	Normal	Vertical									
	Admissible	Any									
Mounting	Screw or 35 mm DIN rail (IEC/EN 60715)										

LK4 and GS2 Disconnect Switches

Table 8.59: Building a Complete GS or LK Switch

To build a complete GS or LK switch, order the following parts:

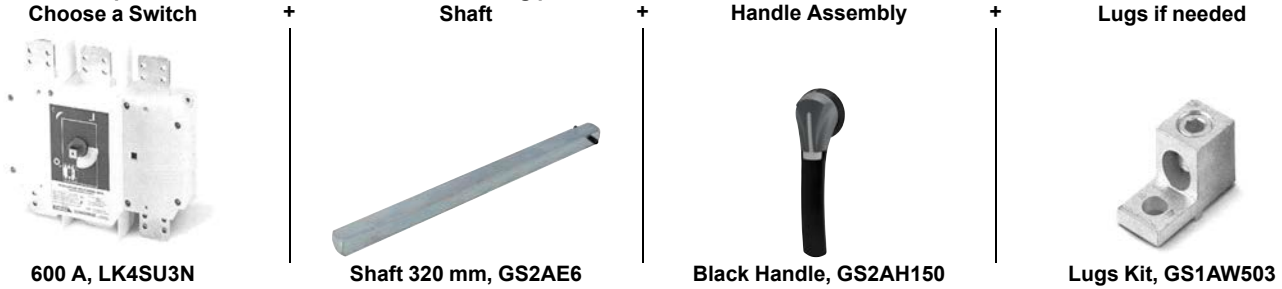

**Example:**  
LK4SU3N (600 A non-fusible switch) + GS2AE6 (320 mm Style D shaft) + GS2AH150 (black/black, locking)

To add auxiliary contacts:

For front-mounted contacts order LK4AD30N (front-mounted auxiliary contact holder) + GS2AM110.

LK4 Nonfusible Disconnect Switches

NOTE: Switches in the shaded area are now available as kits. See Table 8.61.

Table 8.60: LK Nonfusible IEC Style Disconnect Switches

Pole	Rating (A)	Catalog No.	Maximum Horsepower Rating				Short Circuit Current Rating, 600 Vac		Shaft Style
			240 V	480 V	600 V	250 Vdc	Fuse	SCCR kA	
NOTE: Switches in the shaded area are now available as kits.									
3	30	LK4DU3CN [1]	10	20	30	—	J	100	AL
3	60	LK4GU3CN [1]	20	40	50	—	J	100	AL
3	100	LK4JU3CN [1]	20	50	50	N/A	J	100	AL
3	100	LK4JU3N	30	75	100	15	J	200	B
3	200	LK4MU3N	75	150	200	15	J	200	B
3	400	LK4QU3N	125	250	350	50	J	200	B
3	600	LK4SU3N	200	400	350	50	J	200	D
3	800	LK4TU3N	200	500	500	—	L	100	D
3	1000	LK4UU3N	200	500	500	—	L	100	D
3	1200	LK4WU3N	200	500	500	—	L	100	D



100-400 A



30-100 A Compact

NOTE: The kit also includes rod LK4AE41CN.



Table 8.61: <sup>New!</sup> Kits for Compact Switches LK4: 30, 60 and 100 A

Rating (A)	Kit Catalog Number	Pieces Included [2]				
		Compact Switch	400 mm Shaft	Handle Color / NEMA Rating	Handle	Guide Cone
30 A	LK4DUKB1	LK4DU3CN	LK4AE41CN	Black / NEMA 1, 12, 3R	LK4AH0110CN	GS2AEH12
	LK4DUKB4	LK4DU3CN	LK4AE41CN	Black / NEMA 4, 4X	LK4AH0410CN	GS2AEH12
	LK4DUKR1	LK4DU3CN	LK4AE41CN	Red / NEMA 1, 12, 3R	LK4AH0120CN	GS2AEH12
	LK4DUKR4	LK4DU3CN	LK4AE41CN	Red / NEMA 4, 4X	LK4AH0420CN	GS2AEH12
60 A	LK4GUKB1	LK4GU3CN	LK4AE41CN	Black / NEMA 1, 12, 3R	LK4AH0110CN	GS2AEH12
	LK4GUKB4	LK4GU3CN	LK4AE41CN	Black / NEMA 4, 4X	LK4AH0410CN	GS2AEH12
	LK4GUKR1	LK4GU3CN	LK4AE41CN	Red / NEMA 1, 12, 3R	LK4AH0120CN	GS2AEH12
	LK4GUKR4	LK4GU3CN	LK4AE41CN	Red / NEMA 4, 4X	LK4AH0420CN	GS2AEH12
100 A	LK4JUKB1	LK4JU3CN	LK4AE41CN	Black / NEMA 1, 12, 3R	LK4AH0110CN	GS2AEH12
	LK4JUKB4	LK4JU3CN	LK4AE41CN	Black / NEMA 4, 4X	LK4AH0410CN	GS2AEH12
	LK4JUKR1	LK4JU3CN	LK4AE41CN	Red / NEMA 1, 12, 3R	LK4AH0120CN	GS2AEH12
	LK4JUKR4	LK4JU3CN	LK4AE41CN	Red / NEMA 4, 4X	LK4AH0420CN	GS2AEH12

[1] No longer sold as components. Purchase Kits containing Switch, Handle, Shaft, and Guide Cone as listed in Table 8.61.

[2] Components are NOT sold separately. Only 400 mm shaft can be purchase separately.





GS2AH130



GS2AH150



GS2AH170

**NOTE:** Switches in the shaded area are now available as kits. See Table 8.61.

**Table 8.62: Handles and Shafts for LK Switches**

Rating (A)	Handle			Shaft		Shaft		Guide Cone <sup>[3]</sup>	Shaft Style	Support Bracket
	Catalog No.	Type	Color	12.6 in. / 320 mm	15.7 in. / 400 mm	19.6 in. / 500 mm	Catalog No.			
<b>NOTE:</b> Switches in the shaded area are now available as kits.										
30–100	LK4AH110CN <sup>[4]</sup>	1, 3R, 12	Black	LK4AE12CN	—	—	GS2AEH12	AL	—	
30–100	LK4AH1120CN <sup>[4]</sup>	1, 3R, 12	Red/Yellow							
30–100	LK4AH410CN <sup>[4]</sup>	4, 4X	Black							
30–100	LK4AH420CN <sup>[4]</sup>	4, 4X	Red/Yellow							
100–400	GS2AH130	1, 3R, 12	Black	GS2AE2	GS2AE21	GS2AE23	GS2AEH12	B	GS2AESB	
100–400	GS2AH140	1, 3R, 12	Red							
100–400	GS2AH430	4, 4X	Black							
100–400	GS2AH440	4, 4X	Red/Yellow							
600	GS2AH150	1, 3R, 4, 4X, 12	Black	GS2AE6	GS2AE61	—	GS2AEH12	D	—	
600	GS2AH160	1, 3R, 4, 4X, 12	Red/Yellow							
800–1200	GS2AH170	1, 3R, 4, 4X, 12	Black							
800–1200	GS2AH180	1, 3R, 4, 4X, 12	Red/Yellow							

**Table 8.63: Auxiliary Contacts for LK Switches**

Switch Amperes	Catalog No.	Description
30–60	MDSAN11	Auxiliary Contact 1 N.O. and 1 N.C.
30–60	MDSAN20	Auxiliary Contact 2 N.O.
100–400	LK4AD10N	Auxiliary Contact 1 N.O. and 1 N.C.
100–400	LK4AD20N	Auxiliary Contact 2 N.O.
600–1200	LK4AD30N	Auxiliary Contact Holder
600–1200	GS2AM110	Auxiliary Contact 1 N.O.
600–1200	GS2AM101	Auxiliary Contact 1 N.C.

**Table 8.64: Terminal Shrouds for LK Switches**

Switch Amperes	Catalog No.	Description
30–60	LK4AP3CN	Shroud Top and Bottom, 3-Pole
100–200	LK4AP33TN	Shroud Top LK4, 3-Pole, 100/200 A
100–200	LK4AP33BN	Shroud Bottom LK4, 3-Pole, 100/200 A
400	LK4AP53TN	Shroud Top LK4, 3-Pole, 400 A
400	LK4AP53BN	Shroud Bottom LK4, 3-Pole, 400 A
600 <sup>[5]</sup>	LK4AP63N	Shroud Bottom LK4, 3-Pole, 600 A
800–1200 <sup>[5]</sup>	LK4AP83N	Shroud Bottom LK4, 3-Pole, 800–1200 A

<sup>[3]</sup> Optional on shafts for LK4DU3CN, LK4GU3CN and LK4JU3CN.  
<sup>[4]</sup> No longer sold as components. Purchase Kits containing Switch, Handle, Shaft, and Guide Cone as listed in Table 8.61.  
<sup>[5]</sup> 600–1200 A standard with top shroud.



GS2GU3N



Auxiliary Contacts  
GS1AD10 + GS2AM110



Shorting Links

**GS2 Fusible Disconnect Switches**

**Table 8.65: GS Fusible IEC Style Disconnect Switches**

Pole	Rating (A)	Catalog No.	Maximum Horsepower Rating				Short Circuit Current Rating, 600 Vac		Shaft Style
			240 V	480 V	600 V	250 Vdc	Fuse	SCCR kA	
3	30	GS1DDU3	7.5	15	20	5	CC	100	AG
3	30	GS1DU3	7.5	15	20	5	J	100	AG
3	30	GS2EEU3	7.5	15	20	5	CC	100	B
3	30	GS2EU3N	7.5	15	20	5	J	100	B
3	60	GS2GU3N	15	30	50	10	J	100	B
3	100	GS2JU3N	30	60	75	20	J	200	B
3	200	GS2MU3N	60	125	150	40	J	200	B
3	400	GS2QU3N	125	250	350	50	J	200	B
3	600	GS2SU3	200	500	500	—	J	200	C
3	800	GS2TU3	200	500	500	—	J	200	C

**Table 8.66: Handles and Shafts for GS Switches [6]**

Rating (A)	Handle			Shaft: 12.6 in. (320 mm)	Shaft: 15.7 in. (400 mm)	Shaft: 19.7 in. (500 mm)	Shaft Guide Catalog No.	Shaft Style	Support Bracket [7]
	Catalog No.	Type	Color	Catalog No.	Catalog No.	Catalog No.			
30-60	GS2AH110	1, 3R, 12	Black	GS2AE8	GS2AE81	—	GS2AEH12	AG	—
30-60	GS2AH120	1, 3R, 12	Red/Yellow						
30-60	GS2AH410	4, 4X	Black						
30-60	GS2AH420	4, 4X	Red/Yellow	GS2AE2	GS2AE21	GS2AE23	GS2AEH12	B	GS2AESB
30-400	GS2AH130	1, 3R, 12	Black						
30-400	GS2AH140	1, 3R, 12	Red/Yellow						
30-400	GS2AH430	4, 4X	Black	GS2AE5	GS2AE51	GS2AE53	GS2AEH12	C	—
30-400	GS2AH440	4, 4X	Red/Yellow						
600-800	GS2AH150	1, 3R, 4, 4X, 12	Black						
600-800	GS2AH160	1, 3R, 4, 4X, 12	Red/Yellow						

**NOTE:** Hole adapter kit for GS1 to GS2 Handles: GS2AH100TO200.

**Table 8.67: Auxiliary Contacts for GS Switches [8]**

Switch Amperes	Catalog No.	Description
30-800	GS1AM110	Auxiliary Contact, 1 N.O.
30-800	GS1AM101	Auxiliary Contact, 1 N.C.
30	GS1AD10	Auxiliary Contact Holder

**Table 8.68: Shorting Links**

For use on:	Shorting Links per Kit	Catalog No.
GS2, 60 A	3	GS1AU203
GS2, 100 A	3	GS1AU303
GS2, 200 A	3	GS1AU403
GS2, 400 A	3	GS1AU503
GS2, 600-800 A	3	GS1AU803

**Table 8.69: NFPA79 Kit**

For Use With:	Description	Kit Part Number
GS2Q3N	NFPA 79 Internal Handle Kit 400 A Switch Shaft	GS2AD040N
GS2GU3N, GS2GLU3N, GS2JU3N, GS2JLU3N	NFPA 79 Internal Handle Kit 60-200 A Switch Shaft	GS2AD030N
GS1DDU3, GS1DU3	NFPA 79 Internal Handle Kit for 5 mm Shafts	GS1AD010

**Table 8.70: Terminal Shrouds for GS Switches, Line or Load [9]**

Switch Amperes	Catalog No.	Description
30-100	—	Standard on product
200	GS2AP43	GS2, 3-Pole, 200 A
400	GS2AP53	GS2, 3-Pole, 400 A
600-800	GS2AP73	GS2, 3-Pole, 600-800 A

[6] GS2AH100TO200—GS1 to GS2 Handle Adapter if using GS1 holes.

[7] Not for use with flange disconnects.

[8] GS1DU3 and GS1DDU3 switches allow up to 4 auxiliary contacts without adding contact holder GS1AD10. For more than 4 contacts, GS1AD10 is required.

[9] Order one terminal shroud per side. For example, order one terminal shroud for either the line side or load side; order two terminal shrouds for both the line side and load side.

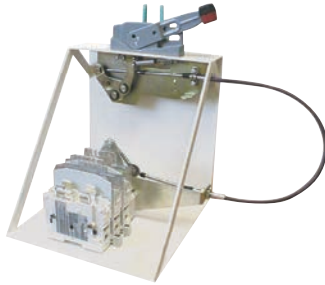

Flange Handle Cable Operator Kit

**Cable Operator Kits for GS2 Switches**

**Table 8.71: Cable Operator Kits for GS2 Switches** [10] [11] [12]

Catalog No.	Description
<b>200 A and Below</b>	
GS2AH36F	36 in. Cable Operator Kits for GS2 Switches, 200 A and Below
GS2AH60F	60 in. Cable Operator Kits for GS2 Switches, 200 A and Below
GS2AH120F	120 in. Cable Operator Kits for GS2 Switches, 200 A and Below
GS2AH144F	144 in. Cable Operator Kits for GS2 Switches, 200 A and Below
GS2AH180F	180 in. Cable Operator Kits for GS2 Switches, 200 A and Below
<b>400 A</b>	
GS2AH460F	60 in. Cable Operator Kits for GS2 Switches, 400 A
GS2AH4120F	120 in. Cable Operator Kits for GS2 Switches, 400 A
GS2AH4144F	144 in. Cable Operator Kits for GS2 Switches, 400 A
GS2AH4180F	180 in. Cable Operator Kits for GS2 Switches, 400 A

**Table 8.72: Handles for use with Cable Operator Kits** [12]

Catalog No.	NEMA Type Enclosure	Type of Handle
9422A1	1, 3, 3R, 4, (Sheet Steel)	6 in.
9422A2	4, 4X (Stainless)	6 in.
9422A3	1, 3, 3R, 4, (Sheet Steel)	4 in.
9422A4	4, 4X (Stainless)	4 in.

**Accessories**

**Table 8.73: Terminal Lugs**



Terminal Lugs

For Use On:	Rating	No. of Wires per Lug	No. of Lugs per Terminal	Lug Size (AWG)	Wire Type	Lugs per Kit	Lug Kit Catalog Number
LK4DU3CN	30	1	1	#12-2/0	Cu	—	Standard
LK4GU3CN	60	1	1	#12-2/0	Cu	—	Standard
LK4JU3N	100	1	1	6-300 kcmil	Cu/Al	6	GS1AW403
LK4MU3N	200	1	1	6-300 kcmil	Cu/Al	6	GS1AW403
LK4QU3N	400	2	1	350 MCM-6	Cu/Al	6	GS1AW603
		1	—	600 MCM-4	—	—	—
		2	1	250 MCM-1/0	Cu/Al	6	GS1AW606
LK4SU3N	600	2	1	2 x 2-600 kcmil	Cu/Al	6	GS1AW503
LK4TU3N	800	2	2	2 x 2-600 kcmil	Cu/Al	12	GS1AW903
LK4UU3N	1000	2	2	2 x 2-600 kcmil	Cu/Al	12	GS1AW903
LK4WU3N	1200	2	2	2 x 2-600 kcmil	Cu/Al	12	GS1AW903
GS1DDU3	30	1	1	#14-#10	Cu	—	Standard
GS1DU3	30	1	1	#14-#10	Cu	—	Standard
GS2EEU3	30	1	1	#14-#10	Cu	—	Standard
GS2EU3N	30	1	1	#14-#6	Cu	—	Standard
GS2GU3N	60	1	1	#10-#6	Cu	—	Standard
GS2JU3N	100	1	1	#12-#1	Cu	—	Standard
GS2MU3N	200	1	1	6-300 kcmil	Cu/Al	6	GS1AW403
GS2QU3N	400	2	1	350 MCM-6	Cu/Al	6	GS1AW603
		1	—	600 MCM-4	—	—	—
		2	1	250 MCM-1/0	Cu/Al	6	GS1AW606
GS2SU3	600	2	1	2 x 2-600 kcmil	Cu/Al	6	GS1AW503
GS2TU3	800	2	1	2 x 2-600 kcmil	Cu/Al	6	GS1AW503

**Table 8.74: Power Distribution Lugs GS1 or GS2 Only**

For Use On:	Rating	No. of Wires per Lug	Lug Size (AWG)	Wire Type	Lugs per Kit	Lug Kit Catalog No.
GS1JU3	100	6	#14-#6	Cu	3	GS1AW306 [13]
GS2MU3N	200	12	#14-#4	Cu	3	GS1AW406
GS2QU3N	400	12	#14-#4	Cu	3	GS1AW406
GS2MU3N	200	6	#12-2/0	Cu	3	GS1AW506
GS2QU3N	400	6	#12-2/0	Cu	3	GS1AW506

[10] Does not include handle. For handle, see Table 8.72.

[11] Not compatible with GS2EEU3.

[12] A 400 A cable operator kit uses either 9422AP1 or AP2 handle.

[13] Cannot be used on GS2JU3N.

**LK4DU3CN and LK4GU3CN, 30–100 A Compact Nonfusible Disconnect Switches**

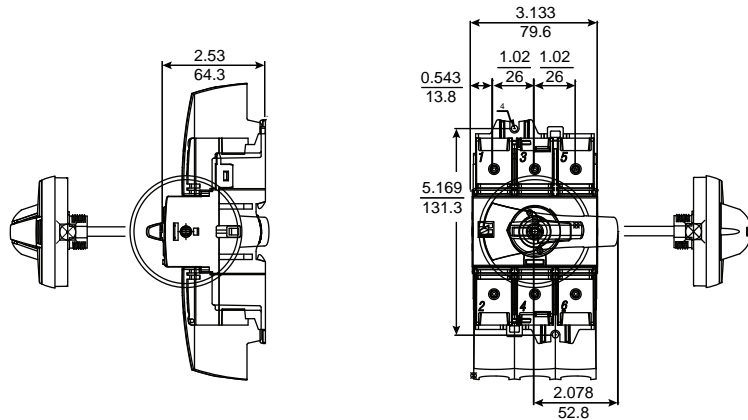

**Handle for 30–100 A Compact Nonfusible Disconnect Switches**

Handle Part No.  
LK4AH110CN  
LK4AH120CN  
LK4AH410CN  
LK4AH420CN

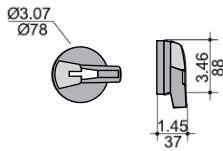

Right-side or front operation

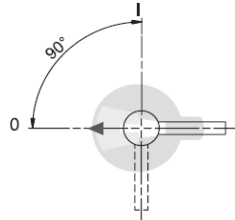

Door drilling with 4 fixing screws

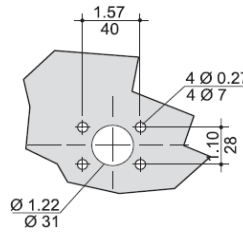

Door drilling with fixing nut

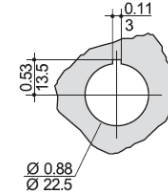

**LK4JU3N / LK4MU3N / LK4QU3N, 100–400 A Nonfusible Disconnect Switches—Dimensions**

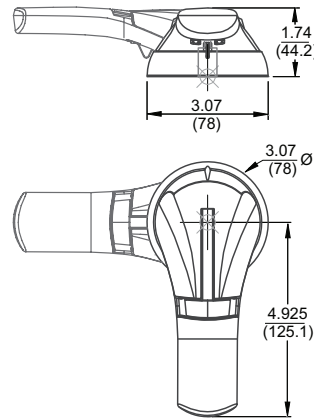
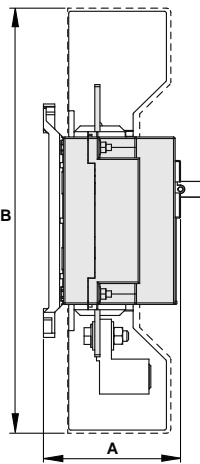
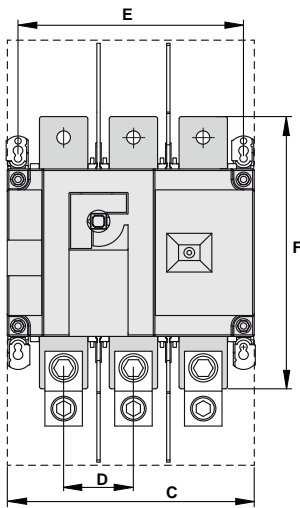

Handle Part No.  
GS2AH130  
GS2AH140  
GS2AH430  
GS2AH440

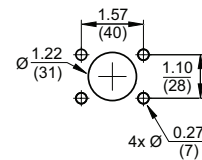

Dimensions:  $\frac{\text{in.}}{\text{mm}}$

Rating (A)	Dimensions = in. (mm)					
	A	B	C	D	E	F
100–200	3.72 (94.6)	10.1 (256)	7.09 (1.80)	1.97 (50)	6.3 (160)	6.3 (160)
400	4.92 (128)	16 (406)	9.05 (230)	2.56 (65)	8.26 (210)	10.2 (260)

**LK4SU3N, 600 A Nonfusible Disconnect Switches—Dimensions**

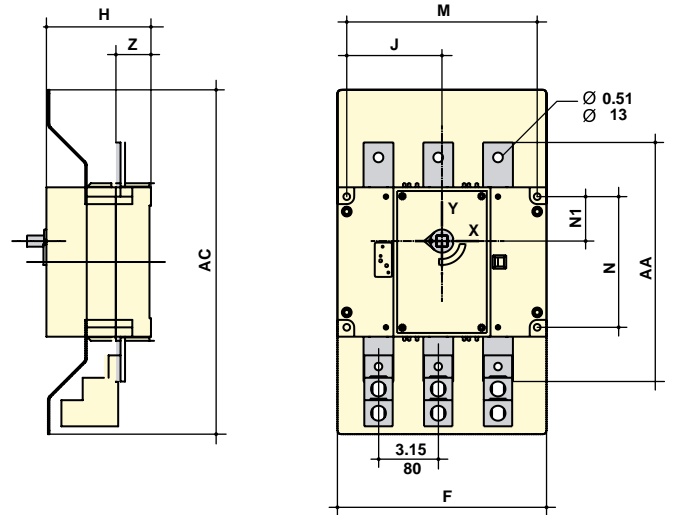

Rating (A)	Dimensions = in. (mm)								
	AC	F	H	J	M	N	N1	AA	Z
600	18.12 (460)	11 (280)	5.5 (140)	5.0 (127.5)	10.03 (255)	6.88 (175)	2.34 (59.5)	12.6 (320)	1.85 (47)

**Handle for 600 and 800 A Fusible Disconnect Switches**

Handle Part No.  
GS2AH150  
GS2AH160

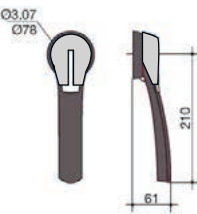

Front operation

Direction of operation

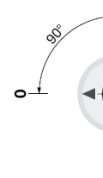

Door drilling template

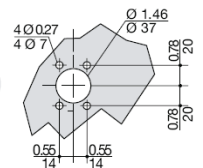

**LK4TU3N / LK4UU3N / LK4WU3N, 800–1200 A Nonfusible Disconnect Switches—Dimensions**

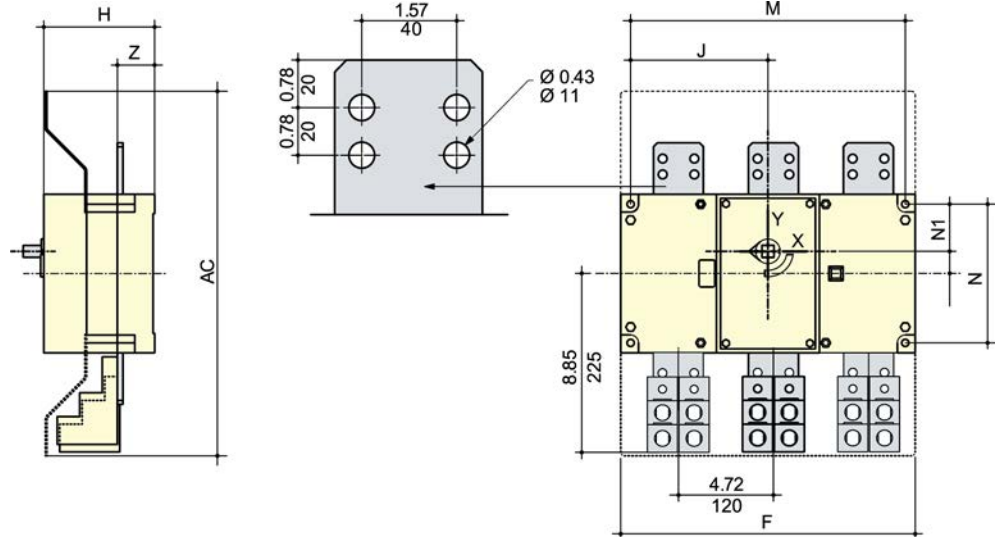

Rating (A)	Dimensions = in. (mm)							
	AC	F	H	J	M	N	N1	Z
800–1200	18.12 (460)	14.64 (372)	5.5 (140)	6.83 (173.5)	13.66 (347)	6.88 (175)	2.34 (59.5)	1.85 (47)

Refer to Catalog 9421CT0301

Handle Part No.  
GS2AH170  
GS2AH180

Dimensions:  $\frac{\text{in.}}{\text{mm}}$

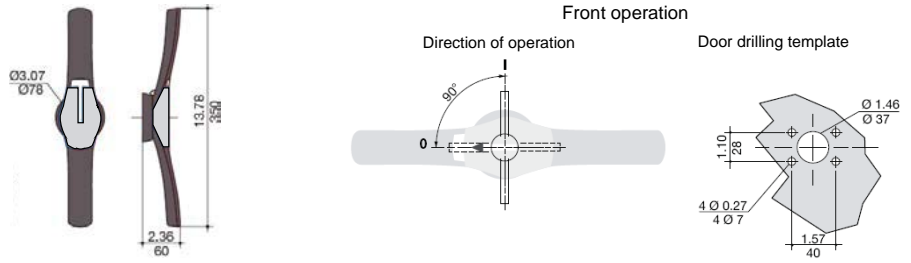

**GS1DDU3, 30 A Fusible Disconnect Switches, Class CC Fuses and GS1DU3, 30 A Fusible Disconnect Switches, Class J Fuses—Dimensions**

Handle for 30 A and 60 A Fusible Disconnect Switches

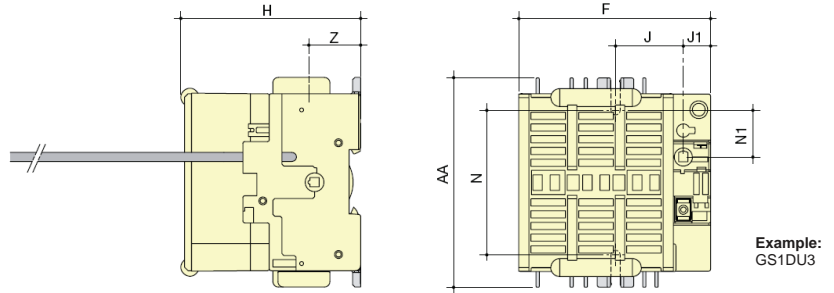
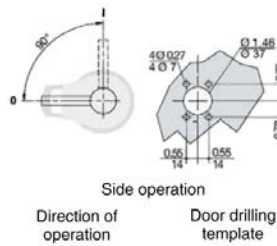
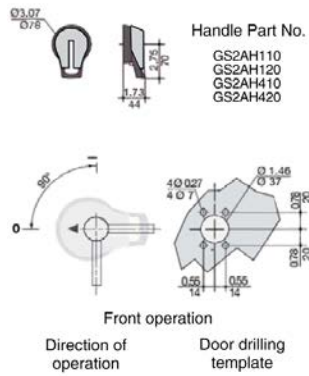

Rating (A)	Dimensions = in. (mm)							
	F	H	J	J1	N	N1	AA	Z
30 / CC	3.78 (96)	3.28 (83.5)	1.47 (37.5)	0.59 (15)	3.13 (79.5)	1 (25.5)	4.56 (116)	1.12 (28.5)
30 / J	4.13 (105)	3.89 (99)	1.47 (37.5)	0.59 (15)	3.13 (79.5)	1 (25.5)	4.56 (116)	1.12 (28.5)

**GS2GU3N, 60 A Fusible Disconnect Switches, Class J Fuses**

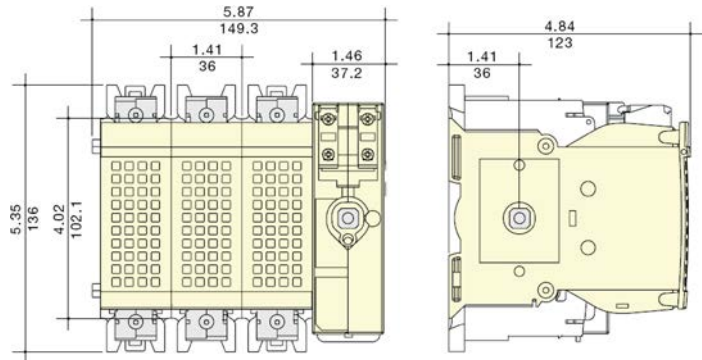

**GS2JU3N, 100 A Fusible Disconnect Switches, Class J Fuses**

Handle for 100 A, 200 A, and 400 A Fusible Disconnect Switches

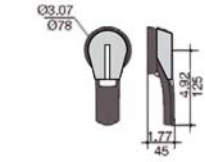

Handle Part No.

- GS2AH130
- GS2AH140
- GS2AH430
- GS2AH440

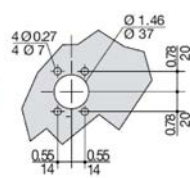
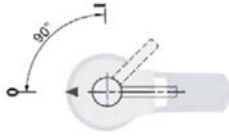

Front operation

Direction of operation

Door drilling template

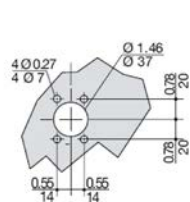
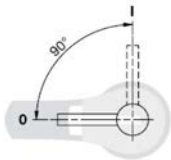

Side operation

Direction of operation

Door drilling template

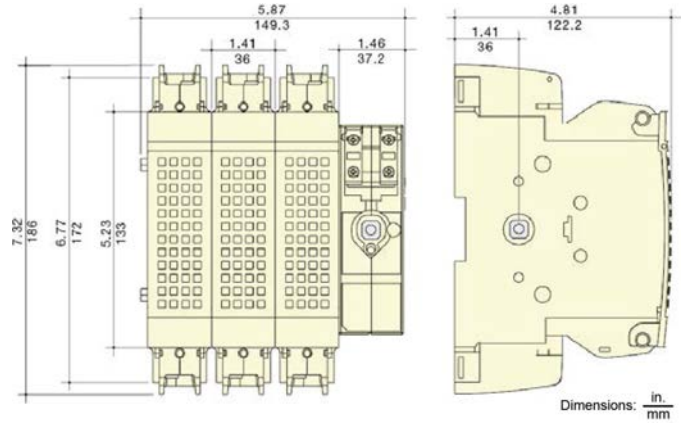

**GS2MU3N, 200 A Fusible Disconnect Switches, Class J Fuses**

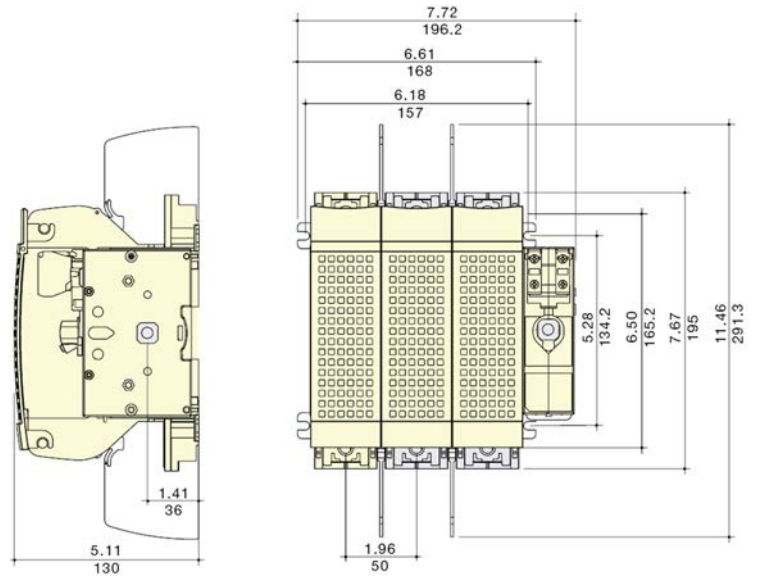

Refer to Catalog 9421CT0301

GS2QU3N, 400 A Fusible Disconnect Switches, Class J Fuses

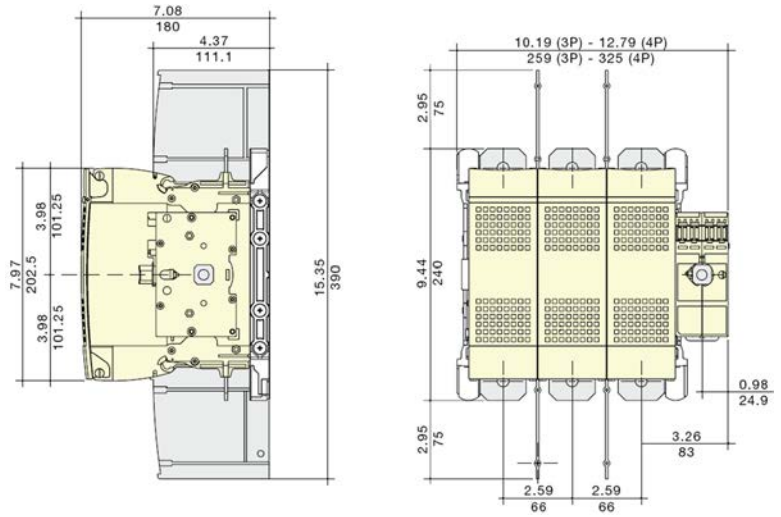

GS2SU3, 600 A Fusible Disconnect Switches, Class J Fuses  
GS2TU3, 800 A Fusible Disconnect Switches, Class J Fuses

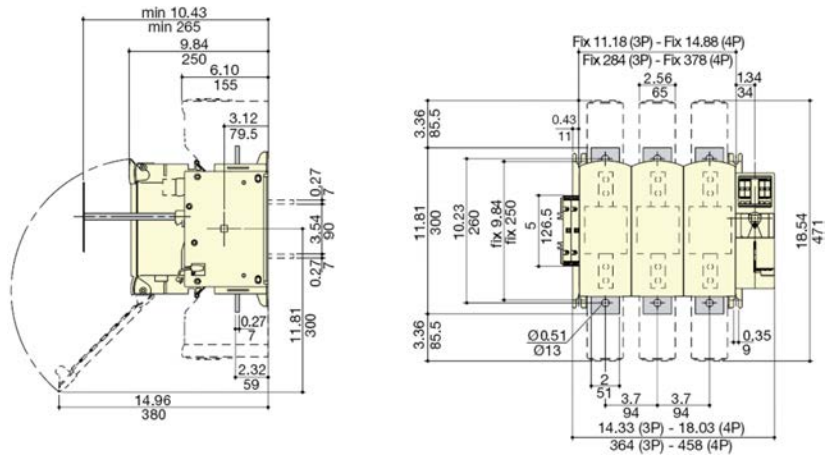
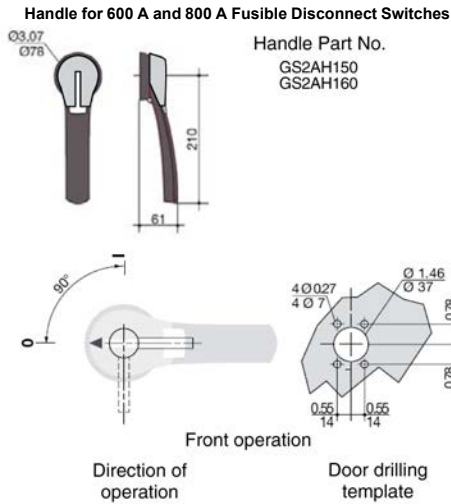



**Disconnect Switches**

The 9422 disconnect switches are the ideal selections for the PV String Combiner Box internal disconnect switch and control panel applications. These switches are designed for variable depth, flange mounting, traditional side mounting and bracket mounting applications providing complete flexibility in the PV string combiner box designs. The switches are compatible with 9422A handle operators and 9423 door mechanisms and are UL 98 recognized (E52369 Vol. 1, Sec. 18) and CSA certified. See page 8-34, page 8-37, and page 8-38 for dimensional information.

**Table 8.75: 9422 Disconnect Switches, Flange Mounted and Variable Depth**

Disconnect Switch Size	Variable Depth (in.)	Maximum Horsepower Ratings						Fuse Type	Fuse Clip Rating (A), Non-Interchangeable Type, For Class H, J, K or R Fuses		Switch and Operating Mechanism ONLY (No Handle Mechanism)	Switch Used with Cable Operators ONLY (No Handle Mechanism or Cable Operator) [1]	Switch and Operating Mechanism with Handle Mechanism, Overpacked[2]			
		AC Systems Volts (Motor Volts)				Vdc			250 V	600 V			Cat. No.	Cat. No.	Type A1 Handle	Type A2 Handle
		208 (200)	240 (230)	480 (460)	600 (575)	250	600								Cat. No.	Cat. No.
30 A	6.625–18	7.5	7.5	15	20	5	15	None	—	—	9422TCN30	9422TCN30C	9422ATCN301	9422ATCN302		
								H, J, K, R	30	—	9422TCF30	9422TCF30C	9422ATCF301	9422ATCF302		
								H, J, K, R	60	30	9422TCF33	9422TCF33C	9422ATCF331	9422ATCF332		
60 A	6.625–18	—	15	30	50	10	30	None	—	—	9422TDN60	9422TDN60C	9422ATDN601	9422ATDN602		
								H, J, K, R	60	30	9422TDF60	9422TDF60C	9422ATDF601	9422ATDF602		
								H, J, K, R	—	60	9422TDF63	9422TDF63C	9422ATDF631	9422ATDF632		
100 A	6.625–18	25	30	60	75	20	50	None	—	—	9422TEN10	9422TEN10C	9422ATEN101	9422ATEN102		
								H, J, K, R	100	100	9422TEF10	9422TEF10C	9422ATEF101	9422ATEF102		
								H, J, K, R	—	—	9422TF1	—	9422ATF11	9422ATF21		
200 A	9.12–19.25 [3]	40	60	125	150	40	50	None	—	—	9422TF2	—	9422ATF12	9422ATF22		
								H, J, K, R	200	200	9422TF2	—	9422ATF12	9422ATF22		
								H, J, K, R	—	400	9422TF3 [4]	—	9422ATF13 [4]	9422ATF23 [4]		
400 A Fixed Depth [5]	11.38 (A5 or A6 Handle)	75	125	250	350	50	50	None	—	—	9422TG1 [6] [7]	—	For handle selection, see page 8-34.			
400 A Variable Depth [5]	15.87–19 (A7 or A8 Handle) [8]							H, J, K, R	400	400	9422TG2 [6] [7]	—				



9422TCN30



Bracket Mounted Disconnect Switch

The 9422 Bracket Mount Disconnect Switch is designed for combiner boxes and control panel applications. The Bracket Mount Disconnect Switch is shipped with the switch and external handle assembled to a bracket, ready for quick installation. A protective trim plate is provided to prevent any mounting screws from being accessible from the front. The trim plate also provides an attractive installation feature. The switches are fully compatible with the 9423 closing mechanisms.

**Table 8.76: 9422 Bracket Mounted Disconnect Switches**

Disconnect Switch Size	Maximum Horsepower Rating						Fuse Type	Fuse Clip Rating (A), Non-Interchangeable Type for Class H, J, K, or R Fuses		Switch and Operating Mechanism Only	
	AC Systems (Motor Volts)				Vdc			250 V	600 V		Cat. No.
	208 (200)	240 (230)	480 (460)	600 (575)	250	600					
30 A	7.5	7.5	15	20	5	15	None	—	—	9422BTCN30	
							H, J, K, R	30	—	9422BTCF30	
							H, J, K, R	60	30	9422BTCF33	
60 A	15	15	30	50	10	30	J [9]	60	30	9422BTCF32	
							None	—	—	9422BTDN60	
							H, J, K, R	60	30	9422BTDN60	
100 A	25	30	60	75	20	50	H, J, K, R	—	60	9422BTDN60	
							H, J, K, R	—	60	9422BTDN60	
							H, J, K, R	—	60	9422BTDN60	
200 A	40	60	125	150	40	50	None	—	—	9422BTEN10	
							H, J, K, R	100	100	9422BTEF10	
							H, J, K, R	100	100	9422BTEF11	
200 A	40	60	125	150	40	50	None	—	—	9422TFB1	
							H, J, K, R	200	200	9422TFB2	
							H, J, K, R	—	400	9422TFB3	

[1] See for ordering information for the cable operator.  
 [2] Variable depth only — no cable operator.  
 [3] 9422 R2 will extend maximum mounting depth 7 inches, see Table 8.86 for information.  
 [4] Accommodates Class J fuses only.  
 [5] Switches are fixed-depth or adjustable depending on handle selection.  
 [6] Commercially available enclosures may not accept 9422TG1 and 2 operating mechanisms. Contact enclosure manufacturer for availability of enclosures for use with these switches.  
 [7] Right hand flange mounting only and requires a special enclosure.  
 [8] Variable in increments of 0.63 inches.  
 [9] Space saving design—Type J fuses mounted on the non-fused bracket.

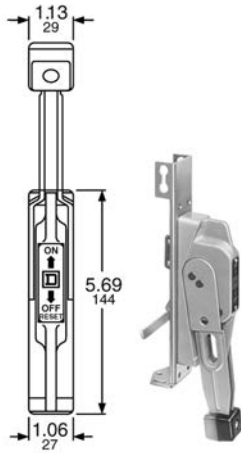

Type A1

Handle Information for 9422 Disconnect Switches

The Handle Mechanism Kit contains all parts needed to mount the handle to the flange of the enclosure. Two flange mounting methods are offered. For right or left hand flange mounting use Types A1–A4 and Types A9–A10 kits. For right-hand mounting only, use Type A5–A8 handles. The type AP1 and AP2 handles are used on the PowerPact™ M and P operating mechanisms, 9422 RM1 and 9422 CMP. The dimensions are identical to 9422 A1.

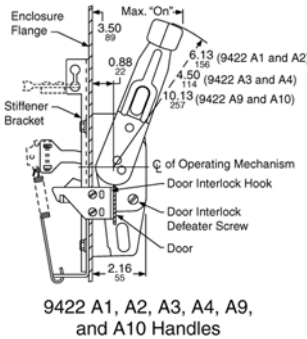

9422 A1, A2, A3, A4, A9, and A10 Handles

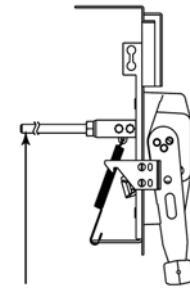

Rod used only on the variable-depth mechanism

Handle Mechanisms

These handle mechanism kits are used with the circuit breaker variable depth and cable operating mechanisms. The kits contain all parts necessary for mounting the handle to the flange of the enclosure. Types A1–A4, A1Y, and AP1 are suitable for right or left-hand flange mounting.

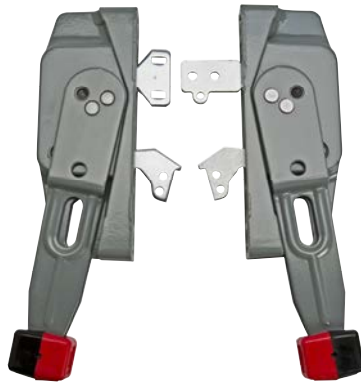

Handle Mechanisms

NOTE: Type 9422A1Y is a 6-in. yellow base with gray handle and red knob.

Table 8.77: 9422 Disconnect Switch and Circuit Breaker Handle Mechanisms

Handle Depth (in.)	NEMA Type 1, 3, 3R, 4, 12 Enclosures	NEMA Type 4, 4X Stainless Steel Enclosures
	Cat. No.	Cat. No.
4 [10]	9422A3	9422A4
6 [10]	9422A1	9422A2
	9422A1Y [11]	
6 [12]	9422AP1	9422AP2
10 [13]	9422A9	9422A10
10	9422AP9	9422AP10
12 [14] [15]	9422A7	9422A8

NOTE: See Handle Information, page 8-34 for dimensional information.

Accessories

Class R Fuse Kits

When installed, this kit rejects all fuses except Class R. The kits are available for field installation. With rejection kit and Class R fuses installed, the switch is UL component recognized for use on systems with fault current up to 200,000 RMS symmetrical amperes.

Table 8.78: Class R Fuse Kits

Disconnect Switch Type	Switch Type	Fuse Clip Rating		Class R Kit Cat No.
		250 V	600 V	
30 A	TCF30	30	—	RFK03
	TCF33	60	30	RFK06
60 A	TDF60	60	30	RFK06
	TDF63	—	60	RFK06H
100 A	TEF10	100	100	RFK10
200 A	TF2	200	200	9999SR4
	TF3	200	200	9999SR4
400 A	TG2	400	400	9999SR5



Handle Mechanisms

[10] Use with 30–200 A, 9422 switches and all circuit breaker mechanisms.  
 [11] Yellow base with gray handle and red knob.  
 [12] Use only with 9422RM1, 9422CMP, and PowerPact M and P operating mechanisms.  
 [13] Use with Type D2 remote or dual adapter kit.  
 [14] Use only with 400 A, 9422TG1 and 9422TG2 disconnect switch.  
 [15] Adjustable depth.

**Electrical Interlocks for Disconnect Switches**

**Table 8.79: Electrical Interlocks**

Disconnect Switch Size	Switch Type	Electrical Interlocks
		Cat No.
30 A 60 A 100 A	TCF, TCN, TDF, TDN, TEF, TEN	9999TC10 [16]
		9999TC20 [17]
	BTCF, BTCN, BTDF, BTDN, BTEF, BTEN	9999TC11 [16]
		9999TC21 [17]
200 A	TF, ATF	9999R8 [16]
	TF, ATF	9999R9 [17]
400 A	TG	9999R35 [16]
	TG	9999R36 [17]

**Internal Barrier Kits**

Provides an additional barrier that helps prevent accidental contact with live parts. Field-installed transparent barriers do not restrict visual inspection of the switch. Barriers provide IEC529 IP2X “finger safe” protection when door of enclosed disconnect switch is open. A convenient door allows use of test probes without accessing fuses and replacement of fuses without removing barrier. Barrier must be used with the skirt kit to enclose a panel mounted 9422 disconnect.



**Table 8.80: Internal Barrier Kits**

Disconnect Switch Size	Barrier	Skirt
	Cat. No.	Cat No.
30 A	SS06	SS0306SK
60 A	SS06	SS0306SK
100 A	SS10	SS10SK

**Cable Operators for 9422 Disconnect Switches**

**Table 8.81: Cable Operators for 9422 Disconnect Switches**

Switch Type	Cable Mechanisms [18]		Cable Mechanisms with A1 Handle for NEMA Type 1, 3, 3R, 4, and 12 Enclosures
	Cable Length (in.)	Cat. No.	Cat. No.
TCN30C, TCF30C, TCF33C, TDN60C, TDF60C, TDF63C, TEN10C, TEF10C	36	9422CFT30	9422CFT31
	48	9422CFT40	—
	60	9422CFT50	9422CFT51
	120	9422CFT10	9422CFT11

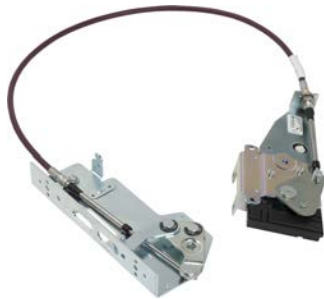

9422CFT40

**Table 8.82: Class 9422 Replacement / Retrofit Fuse Clip Kits**

Disconnect Switch Size	Switch Type	Fuse Type	Fuse Clip Rating (A)		Line and Load Fuse Clip Kit (includes load base and fuse pullers)
			250 V	600 V	Cat. No.
30 A	TCF30 TCN30 TCF33	H, K, J, R	30	—	9422TC30
			60	30	9422TC33
60 A	TDN60	H, K, J, R	60	30	9422TC33
			—	60	9422TD63

**Table 8.83: Lug Data**

Disconnect Switch Size	Wire Size (Min.–Max.)		Lug Kits, Cu	Lug Kits, Al
	Cu	Al	Cat No.	Cat No.
30–60 A	14–2 AWG	10–2 AWG	CL0306F	AL0306F
100 A	10–0 AWG	6–0 AWG	CL10F	AL10F
200 A	6 AWG – 600 kcmil	6 AWG – 600 kcmil	—	—
400 A	4 AWG – 500 kcmil	—	—	—

[16] 1 N.C. or N.O. Contact depending on wiring.  
 [17] 2 N.C. or N.O. or 1 N.O. or 1 N.C. Contact depending on wiring.  
 [18] Purchase handle mechanism separately (9422A1, A2, A3, or A4).

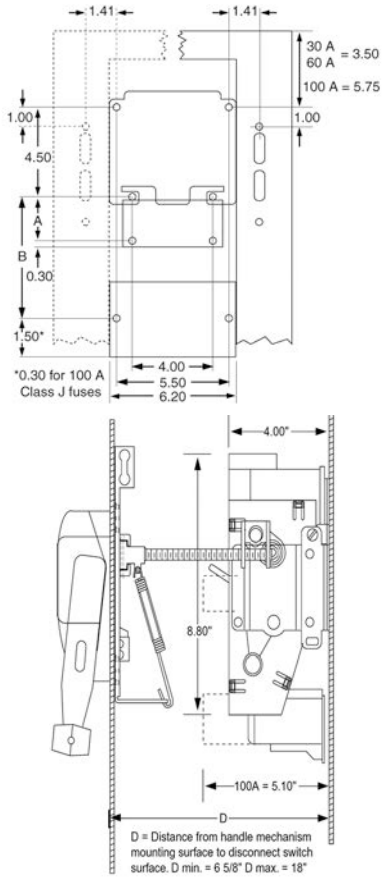

Table 8.84: Dimensions 30, 60, and 100 A Class 9422 Disconnect Switches

Switch Type	Maximum Voltage	Fuse Type	Dimension A	Dimension B
30 A	30 A, 250 V	H, K, R	1.625	—
	30 A, 600 V	H, K, R	4.25	
	30 A, 600 V	J	1.625	
60 A	60 A, 250 V	H, K, R	2.25	
	60 A, 600 V	H, K, R	4.75	
	60 A, 600 V	J	1.625	
100 A	100 A, 250 V	H, K, R	—	3.25
	100 A, 600 V	H, K, R	—	5.25
	100 A, 600 V	J	—	3.25

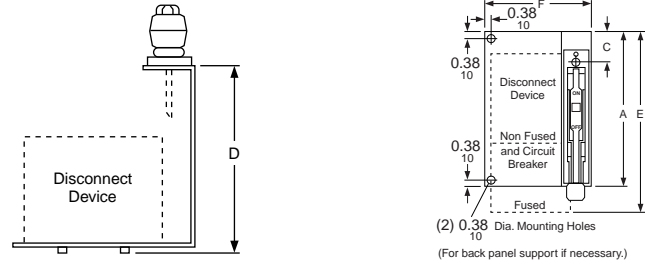

Table 8.85: Dimensions

Type	A in. (mm)	C in. (mm)	D in. (mm)	Min. Enclosure Depth [19] in. (mm)	E in. (mm)	
					Fusible Device	F in. (mm)
BTCN, BTDN, BTEN	—	—	6.56 (167)	8.00 (203)	—	—
BTCF, BTDF, BTEF	9.50 (241)	1.88 (48)	8.56 (217)	10.00 (254)	11.88 (302)	6.38 (162)
TFB1	11.50 (292)	3.88 (99)	9.50 (241)	12.00 (305)	—	13.19 (335)

**NOTE:** Back panel support is recommended for Types TFB1, 2, & 3. Other devices may also require support if the flange is not sufficiently rigid.

[19] The minimum enclosure depth is greater than Dimension D since additional space is needed when mounting the mechanism.

**Dimensions**

**Table 8.86: Dimensions (in. / mm) for 200 A Type TF Disconnect Switches**

Type	Switch Size		A	B	C	D [20]	E	F	G	H	J	K	L	M	N	P	Q	R	S	T
	(A)	Fuse Clips																		
TF1	200	None	13.33 339	9.38 238	1.64 42	9.12-19.25 232-489	2.33 59	8.00 203	—	—	—	9.44 240	6.50 165	9.53 242	—	—	—	3.14 80	1.03 26	0.75 19
TF2	200	Class J 200 A 600 V	13.33 339	9.38 238	1.64 42	9.12-19.25 232-489	2.33 59	8.00 203	0.09 3	—	2.77 70	9.44 240	6.50 165	—	14.11 358	—	9.63 245	3.14 80	1.03 26	0.75 19
TF2	200	Class H, K, R 200 A 250 V	13.33 339	9.38 238	1.64 42	9.12-19.25 232-489	2.33 59	8.00 203	0.09 3	—	4.14 105	9.44 240	6.50 165	—	15.48 393	—	9.63 245	3.14 80	1.03 26	0.75 19
TF2	200	Class H, K, R 200 A 600 V	13.33 339	9.38 238	1.64 42	9.12-19.25 232-489	2.33 59	8.00 203	0.09 3	—	6.64 169	9.44 240	6.50 165	—	17.98 457	—	9.63 245	3.14 80	1.03 26	0.75 19
TF3	200	Class J 400 A 600 V	13.33 339	9.38 238	1.64 42	9.12-19.25 232-489	2.33 59	8.00 203	0.09 3	—	2.77 70	9.44 240	6.50 165	9.53 242	18.53 471	—	9.63 245	3.14 80	1.03 26	0.75 19

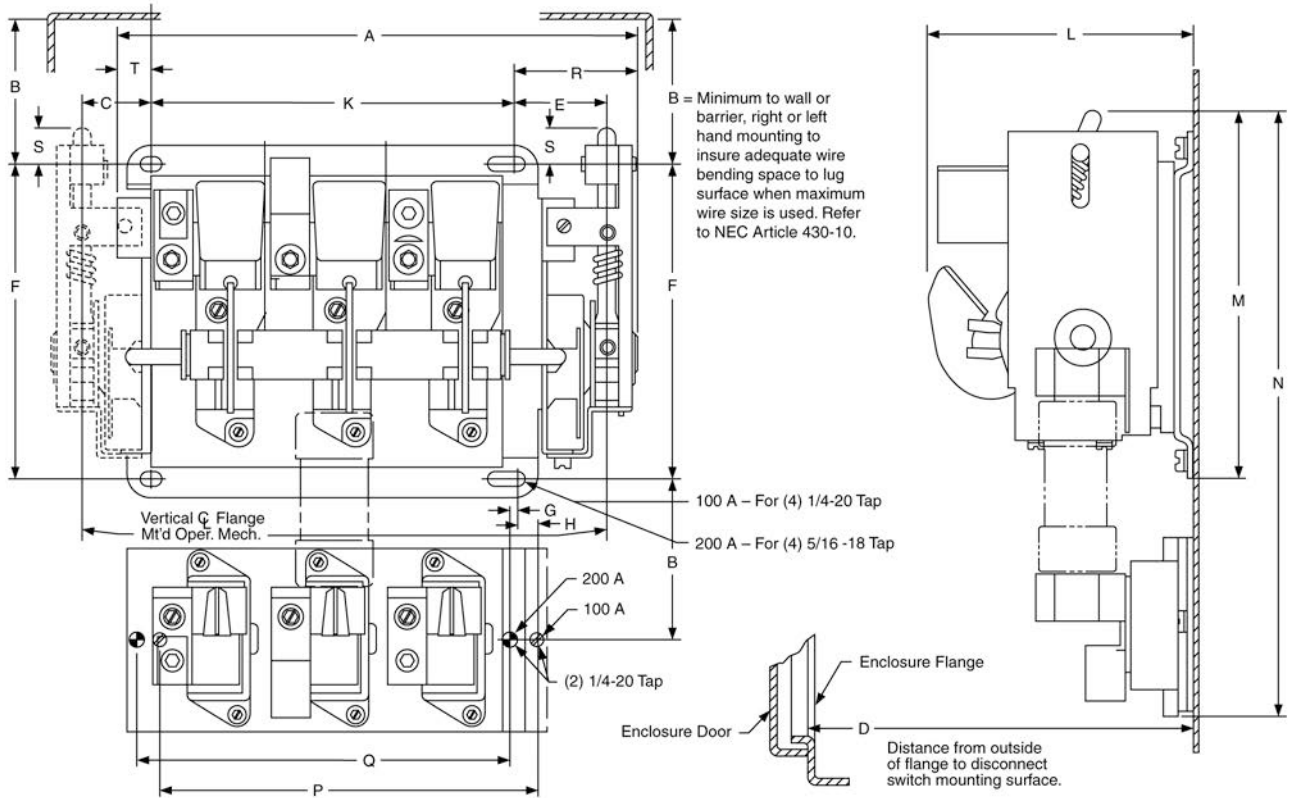

[20] The dimensions shown may be extended 7 in. by using 9422R2 (two required per switch).

Disconnect Switches—400 A Type TG

Outline Dimensions and General Location

400 A Disconnect Switches Nonfusible and Non-Interchangeable Fuse Clip Type Fusible Switches

Table 8.87: Handle Mechanism—Types A7 and A8

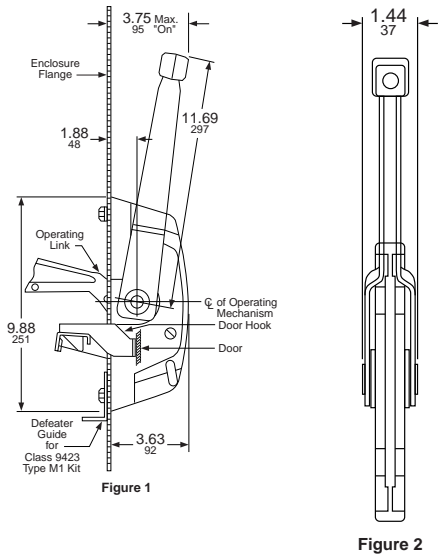

**NOTE:** Commercially available enclosures may not accept type TG operating mechanisms. Contact the enclosure manufacturer for availability of enclosures for use with these switches.

Switch Type	B	X
TG1, 2	11.28 286	16.06 408

**NOTE:** B and X = Minimum to wall or barrier to ensure adequate wire bending space to lug surface when maximum wire size is used. Refer to NEC Article 430.10.

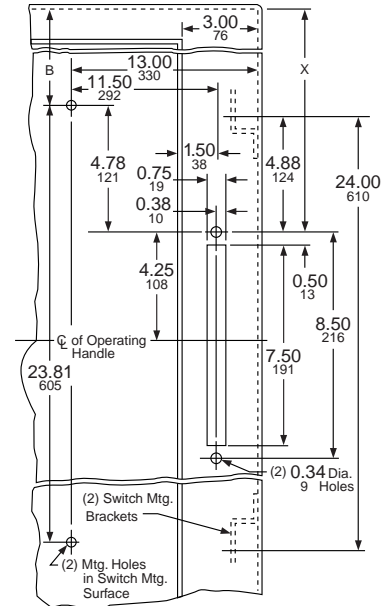

Figure 3

Table 8.88: Nonfusible and Fusible Switches

Dimension D = Distance from outside of flange to disconnect switch mounting surface.

For Type TG1 or TG2 with:

Type A7 or A8 adjustable depth handle mechanism	D =	15.87 403	to	19 483
In steps of		0.63 16		

**NOTE:** Copper lugs are standard on all Type TG disconnect switches.

\* D = Mounting depth measured from the switch mounting surface to the surface of flange.

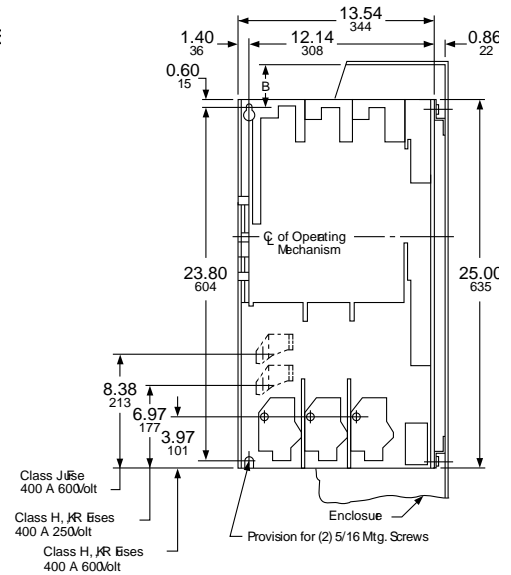
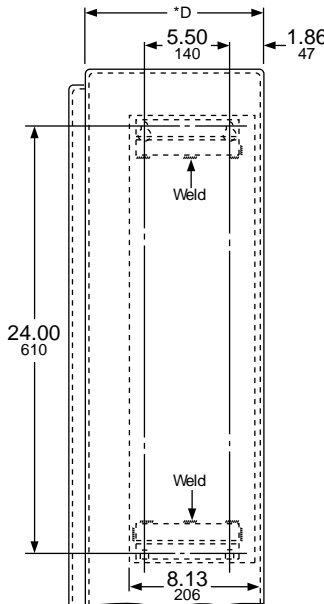

Dim. =  $\frac{\text{in.}}{\text{mm}}$

**Type L Circuit Breaker Mechanisms**

Type L door-mounted, variable depth operating mechanisms feature heavy duty, all metal construction with trip indication. All mechanisms can be padlocked in the Off position when the enclosure door is open. Further, the handle assemblies can be locked Off with up to three padlocks, which also locks the enclosure when the door is closed. (The 3 in. handle accepts one padlock.) Complete kits are rated for NEMA 1, 3R, and 12 enclosures. They include a handle assembly, operating mechanism, and shaft assembly.



**9421 Type L  
Circuit Breaker Operating Mechanism**

**Table 8.89: Complete Kits**

Complete Kit Does Not Include Circuit Breaker			Includes Operating Mechanism and Handle					
Use With			Standard 6 in. Handle			Short 3 in. Handle		
			Standard Shaft Kit		Long Shaft Kit	Long Shaft Kit		
Circuit Breaker or Interrupter Type	No. of Poles	Frame Size (A)	Cat. No.	Mounting Depth [1]	Cat. No.	Mounting Depth [1]	Cat. No.	Mounting Depth [1]
PowerPact™ B	2-3	125	9421LB1	5.50-10.75	9421LB4	5.50-21.38	9421LB3	5.50-21.38
PowerPact H and J	2-3	250	9421LJ1	5.50-10.75	9421LJ4	5.50-21.38	9421LJ3	5.50-21.38
PowerPact L	2-3	600	9421LD1	7.25-12.06	9421LD4	7.25-22.63	3 in. handles are not recommended for use with these circuit breakers.	
PowerPact M and P [2]	3	1200	9421LW1 [3]	9.00-12.50	9421LW4 [3]	9.00-23.50		

**Table 8.90: Component Parts**

Use With			3 in. Handle Assemblies NEMA 1, 3R, 12	Standard Handle Assemblies NEMA 1, 3R, 12	Operating Mechanism Includes Lockout	Standard Shaft (Support Bracket Not Required)		Long Shaft (Support Bracket Required)	
Circuit Breaker or Interrupter Type	No. of Poles	Frame Size (A)	Cat. No.	Cat. No.	Cat. No.	Mounting Depth [1]	Cat. No.	Mounting Depth [1]	Cat. No.
PowerPact B	2-3	125	9421LH3 [4]	9421LH6 [4]	9421LB7	5.50-10.75	9421LS8	5.50-21.38	9421LS13
PowerPact H & J	2-3	250	9421LH3 [4]	9421LH6 [4]	9421LJ7	5.50-10.25	9421LS8	5.50-21.38	9421LS13
PowerPact D & L	2-3	600	[5]	9421LH6 [4]	9421LD7	7.25-12.06	9421LS8	7.25-22.63	9421LS13
	4	1200 (300 V)	—	9421LH6 [4]	9421LD14	7.25-12.06	9421LS8	—	—
				—	9421LD44	—	—	7.25-22.63	9421LS13
PowerPact M & P [2]	3	1200	[5]	9421LHP8 [4]	9421LW7	7.19-11.63	9421LS8	7.19-22.25	9421LS10

**Table 8.91: NEMA 4 and 4X Handle Assemblies**

Use With			Standard Handle Assemblies		Special 3 in. Version	
Circuit Breaker or Interrupter Type	No. of Poles	Frame Size (A)	NEMA 1, 3R, 4, 12 (Painted)	NEMA 1, 3R, 4, 4X, 12 (Chrome Plated)	NEMA 1, 3R, 4, 12 (Painted)	NEMA 1, 3R, 4, 4X, 12 (Chrome Plated)
			Cat. No.	Cat. No.	Cat. No.	Cat. No.
PowerPact B	2-3	125	9421LH46	9421LC46	9421LH43	9421LC43
PowerPact H and J; NSF	2-3	250	9421LH46	9421LC46	9421LH43	9421LC43
PowerPact D and L	2-3	600	9421LH46	9421LC46	3 in. handles are not recommended for use with these circuit breakers.	
PowerPact M and P	3	1200	9421LHP48	9421LCP48		

**Table 8.92: Auxiliary and Alarm Switches for PowerPact™ Circuit Breakers**

Description	B-Frame	H- and J-Frame	D- and L-Frame	D- and L-Frame
1 Auxiliary Switch 1a 1b	LV26950	S29450	S29450	S29450
2 Auxiliary Switch 2a 2b	—	2 x S29450	2 x S29450	2 x S29450
3 Auxiliary Switch 3a 3b	—	—	3 x S29450	3 x S29450

**NOTE:** The location of the accessory in the circuit breaker determines its function.



[1] Mounting depth measured in inches from circuit breaker mounting surface (control panel) to outside of enclosure door.  
 [2] These circuit breaker operating mechanisms must use the 9421LHP\*\* or LCP\*\* handles only.  
 [3] Type LW1 and LW4 include an 8 in. handle (9421LHP8) rather than a 6 in. handle.  
 [4] For a red handle and yellow bezel, add suffix RY to catalog number, e.g., 9421LH6RY.  
 [5] 3 in. handles are not recommended for use with these circuit breakers.

Dimensions for Type L Operating Mechanisms

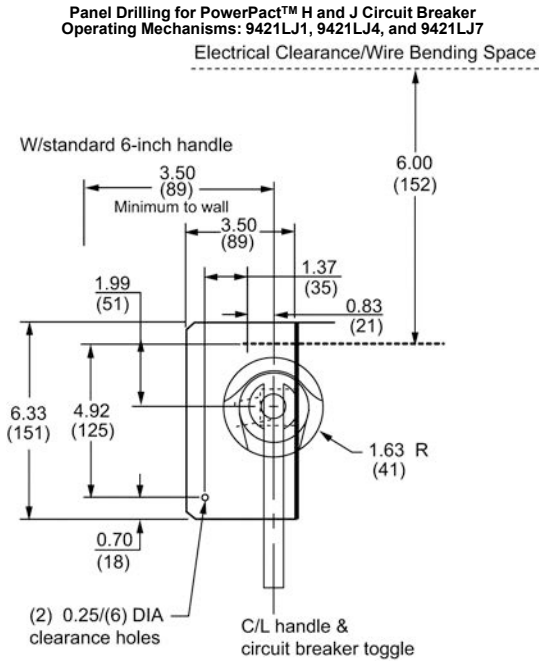

Panel Drilling for PowerPact™ D and L Circuit Breaker Operating Mechanisms: 9421LD1, 9421LD4, and 9421LD7

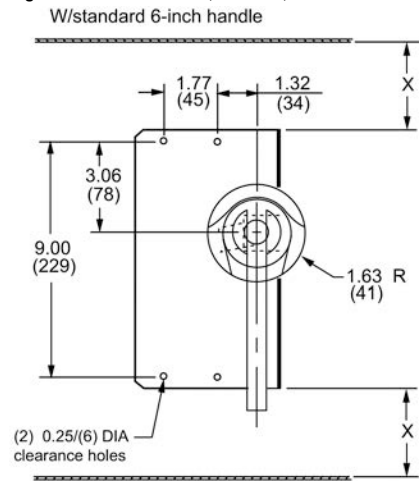

X: Minimum to wall or barrier to insure adequate wire bending space to lug surface when the maximum wire size is used. Refer to NEC 430-10.

Panel Drilling for PowerPact™ M and P Circuit Breaker Operating Mechanisms: 9421LW1, 9421LW4, and 9421LW7

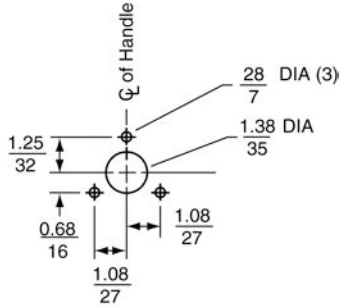

Door Drilling Dimensions

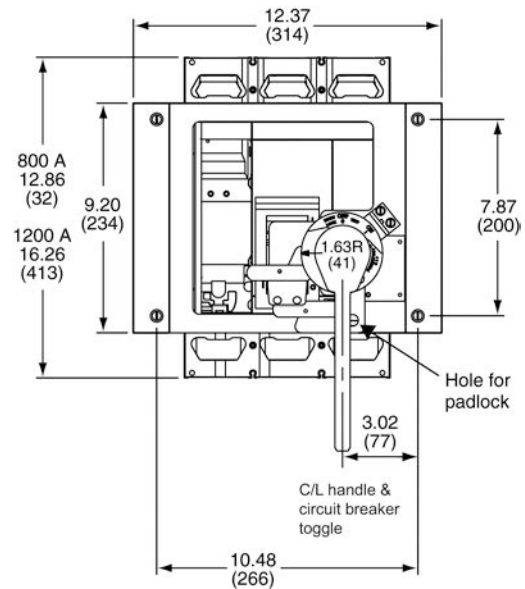
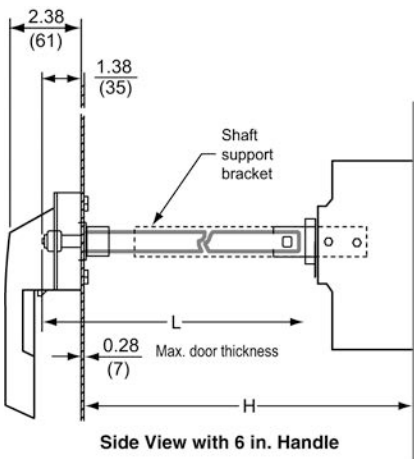
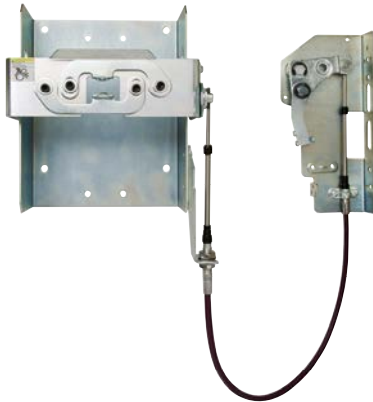

Table 8.93: Shaft Cutting Dimensions

Class	Type	Shaft Length Formula	H = Standard Shaft		H = Long Shaft	
			Min.	Max.	Min.	Max.
9421	LJ1, LJ4, LJ7	L = H - 3.00 (76)	5.5 (138)	10.75 (273)	5.5 (138)	21.63 (543)
9421	LD1, LD4, LD7	L = H - 4.25 (108)	7.25 (184)	12.06 (306)	7.25 (184)	22.63 (575)
9421	LW1, LW4, LW7	L = H - 4.89 (124)	7.19 (183)	11.63 (295)	7.19 (183)	22.25 (565)







**Flexible Cable Mechanism  
9422CSJ30**

**Flexible Cable Mechanisms**

- For use with Class 9422 handle operators (you must select a 9422A• handle to complete the operating mechanism)
- Specially designed for tall, deep enclosures where placement flexibility is required

**Table 8.94: Flexible Cable Mechanisms for use with Schneider Electric™ (formerly Merlin Gerin™) Circuit Breakers and PowerPact™ 3-Pole Circuit Breakers**

Circuit Breaker Type	No. of Poles	Frame Size (A)	Cable Mechanism	
			Length	Catalog No.
PowerPact B-Frame	2–3	125	36 in.	9422CSB30
			60 in.	9422CSB50
			84 in.	9422CSB70
			120 in.	9422CSB10
MG-NSF PowerPact H- and J-Frame	2–3	250	36 in.	9422CSF30
			60 in.	9422CSF50
			84 in.	9422CSF70
			120 in.	9422CSF10
MG-NSF	4	250	36 in.	9422CSF304
			60 in.	9422CSF504
			120 in.	9422CSF104
MG-NSJ PowerPact D- and L-Frame	3	600	36 in.	9422CSJ30
			60 in.	9422CSJ50
			120 in.	9422CSJ10
MG-NSJ PowerPact D- and L-Frame	4	600	36 in.	9422CSJ304
			60 in.	9422CSJ504
			120 in.	9422CSJ104
PowerPact M- and P-Frame [6]	3	1200	48 in.	9422CMP40
			50 in.	9422CMP50
			120 in.	9422CMP10

**NOTE:** Refer to NEC Article 430-10 for minimum dimension X from circuit breaker top mounting hole to wall or barrier to ensure adequate wire bending space.  
**NOTE:** Bend radius in cable must never be less than 6 inches. Electrical clearances must be maintained between cable and live electrical parts.

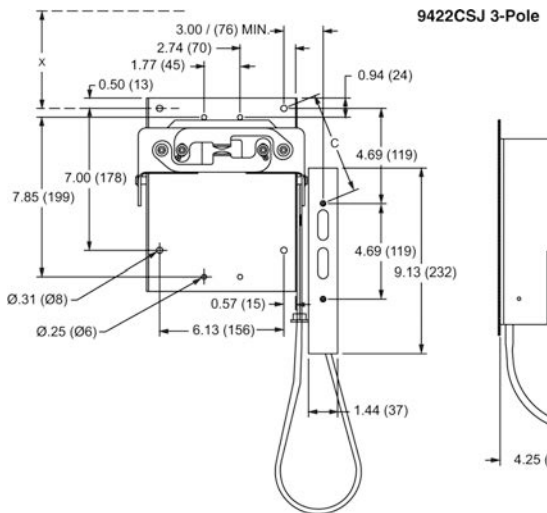
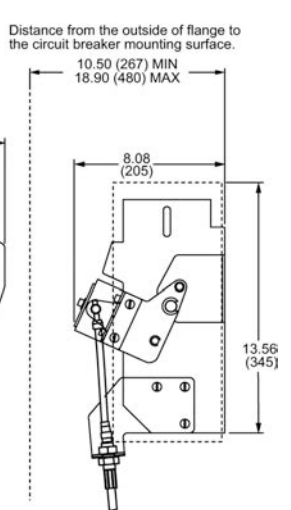
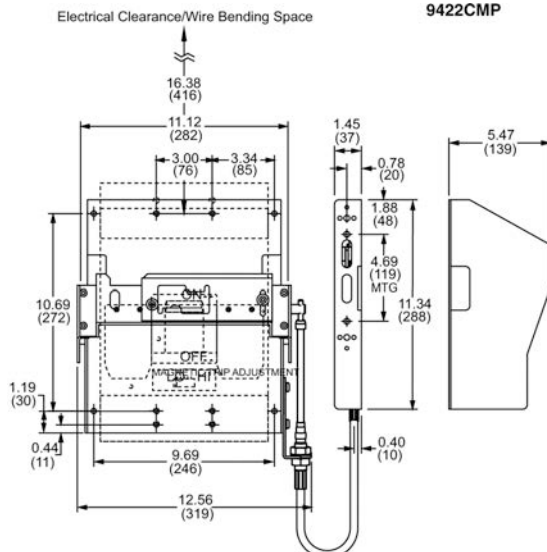
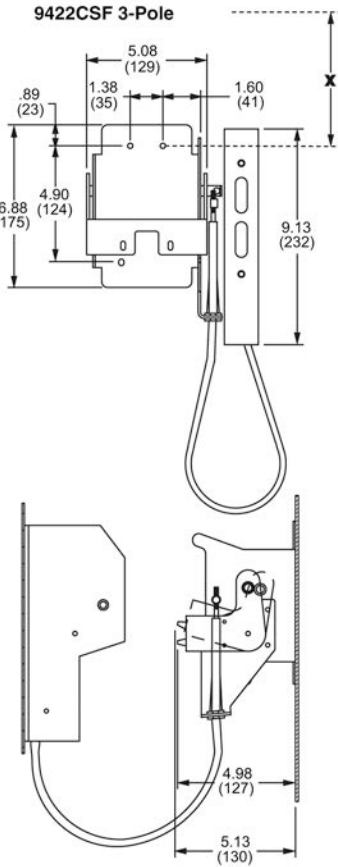

Dimensions: in./mm

[6] Must use 9422AP1 or 9422AP2 Handle with this operating mechanism.



### Dual Cable Operating Mechanisms for Square D™ Circuit Breakers

Dual Cable Operating Mechanisms are designed for use with Square D brand PowerPact™ B, D, H, J, and L circuit breakers through 600 A frame sizes. The cable mechanisms allow for a single handle operator, Class 9422A, to operate both circuit breakers. The cable mechanism is designed especially for tall, deep enclosures where placement flexibility is required. There are numerous cable arrangements to choose from to accommodate many applications.

#### Features

- Separate cables for each circuit breaker
- Rugged metal flange handle operator
- Maximized flexibility of circuit breaker placement for existing and new applications
- Control panel can be fed from two separate supply voltages (if required)
- Dual mechanism allows both separate supply voltages to be controlled by a single handle to improve security features

Table 8.95: Dual Cable Operating Mechanisms Selection

Circuit Breaker Type	Cable Length in. / mm (quantity)	Catalog Number	Frame Size (max.)
PowerPact B	120 in. / 3048 mm (2)	9422CSBD1	125 A
	36 in. / 914 mm (1) 60 in. / 1524 mm (1)	9422CSBD35	
	60 in. / 1524 mm (1-CSF 3 pole) 60 in. / 1524 mm (1-CSF 4 pole)	9422CSBD55	
	36 in. / 914 mm (1) 120 in. / 3048 mm (1)	9422CSBD31	
	36 in. / 914 mm (2)	9422CSBD33	
	60 in. / 1524 mm (1) 120 in. / 3048 mm (1)	9422CSBD51	
PowerPact H & J MG NSF	120 in. / 3048 mm (2)	9422CSFD1	250 A
	36 in. / 914 mm (1) 60 in. / 1524 mm (1)	9422CSFD35	
	60 in. / 1524 mm (1-CSF 3 pole) 60 in. / 1524 mm (1-CSF 4 pole)	9422CSFD345	
	36 in. / 914 mm (1) 120 in. / 3048 mm (1)	9422CSFD31	
	36 in. / 914 mm (2)	9422CSFD33	
	60 in. / 1524 mm (1) 120 in. / 3048 mm (1)	9422CSFD51	
	60 in. / 1524 mm (2)	9422CSFD55	
	60 in. / 1524 mm (2-CSJ) 120 in. / 3048 mm (2-CSJ)	9422CSJD50 [7]	
60 in. / 1524 mm and 120 in. / 3048 mm (2-CSJ)	9422CSJD51 [8]		
120 in. / 3048 mm (1-CSF) and 120 in. / 3048 mm (1-CSJ)	9422CSFJD10	250 A and 600 A	
60 in. / 1524 mm (1-CSF) 60 in. / 1524 mm (1-CSJ)	9422CSFJD50		

### Handle Mechanisms

These handle mechanism kits are used with the circuit breaker variable depth and cable operating mechanisms. The kits contain all parts necessary for mounting the handle to the flange of the enclosure. Types A1–A4, A1Y, and AP1 are suitable for right or left-hand flange mounting.

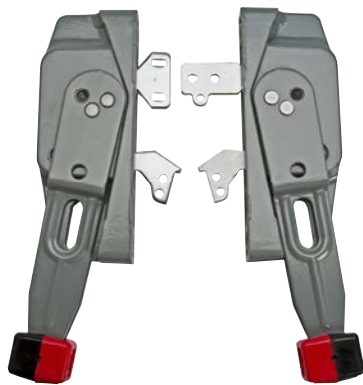

Handle Mechanisms

NOTE: Type 9422A1Y is a 6-in. yellow base with gray handle and red knob.

Table 8.96: 9422 Disconnect Switch and Circuit Breaker Handle Mechanisms

Handle Depth (in.)	NEMA Type 1, 3, 3R, 4, 12 Enclosures	NEMA Type 4, 4X Stainless Steel Enclosures
	Cat. No.	Cat. No.
4 [9]	9422A3	9422A4
6 [9]	9422A1	9422A2
	9422A1Y [10]	
6 [11]	9422AP1	9422AP2
10 [12]	9422A9	9422A10
10	9422AP9	9422AP10
12 [13] [14]	9422A7	9422A8

NOTE: See Handle Information, page 8-34 for dimensional information.

[7] Must use the 9422AP1 or 9422AP2 operating handle with this operating mechanism.

[8] Must use the 9422AP1 or 9422AP2 operating handle with this operating mechanism.

[9] Use with 30–200 A, 9422 switches and all circuit breaker mechanisms.

[10] Yellow base with gray handle and red knob.

[11] Use only with 9422RM1, 9422CMP, and PowerPact M and P operating mechanisms.

[12] Use with Type D2 remote or dual adapter kit.

[13] Use only with 400 A, 9422TG1 and 9422TG2 disconnect switch.

[14] Adjustable depth.



**9422 Type R  
Circuit Breaker Mechanism**

**Flange-Mounted, Variable-Depth Operating Mechanisms**

Designed for installation in custom built control enclosures where main or branch circuit protective devices are required. All circuit breaker operating mechanisms are suitable for either right- or left-hand flange mounting, convertible on the job.

**NOTE:** The operating mechanisms do not include handle mechanisms. You must select a 9422A• handle to complete the installation.

**Table 8.97: Variable-Depth Operating Mechanisms for Use with Schneider Electric™ Brand Circuit Breakers (Formerly Merlin Gerin™ Brand)**

Use with				Operating Mechanism (Does Not Include Handle Mechanism)
Circuit Breaker Frame Size	No. of Poles	Frame Size A	Variable Depth Mtg. Range (in.) [15]	Cat. No.
Schneider Electric (formerly Merlin Gerin) Circuit Breakers and PowerPact™ Frame 3-Pole Circuit Breakers				
PowerPact B-Frame	2-3	125	5.88-17.75	9422RB1
MG-NSF PowerPact H- and J-Frame	2-3	250	5.88-17.75	9422RQ1
MG-NSJ PowerPact D- and L-Frame	3	600	9.00-17.75	9422RS1
PowerPact M- and P-Frame [16]	3	1200	10.50-18.38	9422RM1

**Table 8.98: Electrical Interlocks—Class 9999**

Description	Cat. No.
Single Pole, Double Throw	9999R26
Double Pole, Double Throw	9999R27

[15] Class 9422 Type R2 will extend mounting depth 7 inches—not recommended for use with the 9422RM1 operating mechanism (see Table 8.96).

[16] These circuit breaker operating mechanisms must use the 9422APx handles.

**Dimensions**

Minimum wall or barrier to insure adequate wire bending space to lug surface when the maximum wire size is used with standard lugs. Refer to NEC 430-10.

Dimensions: in.  
mm

