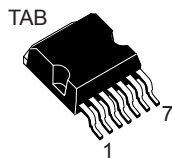
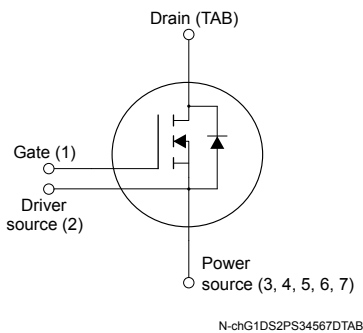

Silicon carbide Power MOSFET 650 V, 55 mΩ typ., 45 A in an H²PAK-7 package

H²PAK-7

Features

Order code	V _{DS}	R _{DS(on)} max.	I _D
SCTH35N65G2V-7	650 V	67 mΩ	45 A

- Very fast and robust intrinsic body diode
- Extremely low gate charge and input capacitance
- Source sensing pin for increased efficiency

Applications

- Switching mode power supply
- DC-DC converters
- Industrial motor control

Description

This silicon carbide Power MOSFET device has been developed using ST's advanced and innovative 2nd generation SiC MOSFET technology. The device features remarkably low on-resistance per unit area and very good switching performance. The variation of switching loss is almost independent of junction temperature.

Product status link

[SCTH35N65G2V-7](#)

Product summary

Order code	SCTH35N65G2V-7
Marking	SCT35N65
Package	H ² PAK-7
Packing	Tape and reel

1 Electrical ratings

Table 1. Absolute maximum ratings

Symbol	Parameter	Value	Unit
V_{DS}	Drain-source voltage	650	V
V_{GS}	Gate-source voltage	-10 to 22	V
	Gate-source voltage (recommended operating range)	-5 to 18	
I_D	Drain current (continuous) at $T_C = 25\text{ °C}$	45	A
	Drain current (continuous) at $T_C = 100\text{ °C}$	35	
$I_{DM}^{(1)}$	Drain current (pulsed)	90	A
P_{TOT}	Total power dissipation at $T_C = 25\text{ °C}$	208	W
T_{stg}	Storage temperature range	-55 to 175	°C
T_J	Operating junction temperature range		°C

1. Pulse width is limited by safe operating area.

Table 2. Thermal data

Symbol	Parameter	Value	Unit
R_{thJC}	Thermal resistance, junction-to-case	0.72	°C/W
R_{thJA}	Thermal resistance, junction-to-ambient	62.5	°C/W

2 Electrical characteristics

($T_C = 25\text{ °C}$ unless otherwise specified)

Table 3. On/off states

Symbol	Parameter	Test conditions	Min.	Typ.	Max.	Unit
$V_{(BR)DSS}$	Drain-source breakdown voltage	$V_{GS} = 0\text{ V}$, $I_D = 1\text{ mA}$	650			V
I_{DSS}	Zero gate voltage drain current	$V_{GS} = 0\text{ V}$, $V_{DS} = 650\text{ V}$			5	μA
I_{GSS}	Gate-body leakage current	$V_{DS} = 0\text{ V}$, $V_{GS} = -10\text{ to }22\text{ V}$			± 100	nA
$V_{GS(th)}$	Gate threshold voltage	$V_{DS} = V_{GS}$, $I_D = 1\text{ mA}$	1.8	3.2	5	V
$R_{DS(on)}$	Static drain-source on-resistance	$V_{GS} = 20\text{ V}$, $I_D = 20\text{ A}$		45	67	m Ω
		$V_{GS} = 18\text{ V}$, $I_D = 20\text{ A}$		55		
		$V_{GS} = 20\text{ V}$, $I_D = 20\text{ A}$, $T_J = 175\text{ °C}$		65		

Table 4. Dynamic, based on HiP247 package option

Symbol	Parameter	Test conditions	Min.	Typ.	Max.	Unit
C_{iss}	Input capacitance	$V_{DS} = 400\text{ V}$, $f = 1\text{ MHz}$, $V_{GS} = 0\text{ V}$	-	1370	-	pF
C_{oss}	Output capacitance		-	125	-	pF
C_{riss}	Reverse transfer capacitance		-	30	-	pF
Q_g	Total gate charge	$V_{DD} = 400\text{ V}$, $V_{GS} = 0\text{ to }20\text{ V}$, $I_D = 20\text{ A}$	-	73	-	nC
Q_{gs}	Gate-source charge		-	14	-	nC
Q_{gd}	Gate-drain charge		-	27	-	nC
R_g	Gate input resistance	$f = 1\text{ MHz}$, $I_D = 0\text{ A}$	-	2	-	Ω

Table 5. Switching energy (inductive load), based on HiP247 package option

Symbol	Parameter	Test conditions	Min.	Typ.	Max.	Unit
E_{on}	Turn-on switching energy	$V_{DD} = 400\text{ V}$, $I_D = 20\text{ A}$	-	100	-	μJ
E_{off}	Turn-off switching energy	$R_G = 10\text{ }\Omega$, $V_{GS} = -5\text{ to }20\text{ V}$	-	35	-	μJ

Table 6. Switching times, based on HiP247 package option

Symbol	Parameter	Test conditions	Min.	Typ.	Max.	Unit
$t_{d(on)}$	Turn-on delay time	$V_{DD} = 400\text{ V}$, $I_D = 20\text{ A}$, $R_G = 4.7\text{ }\Omega$, $V_{GS} = -5\text{ to }20\text{ V}$	-	16	-	ns
t_f	Fall time		-	14	-	
$t_{d(off)}$	Turn-off delay time		-	35	-	
t_r	Rise time		-	9	-	

Table 7. Reverse SiC diode characteristics

Symbol	Parameter	Test conditions	Min.	Typ.	Max.	Unit
V_{SD}	Diode forward voltage	$I_F = 20\text{ A}$, $V_{GS} = 0\text{ V}$	-	3.3	-	V
t_{rr}	Reverse recovery time	$V_{DD} = 400\text{ V}$, $I_F = 20\text{ A}$, $di/dt = 1000\text{ A}/\mu\text{s}$	-	18	-	ns
Q_{rr}	Reverse recovery charge		-	85	-	nC
I_{RRM}	Reverse recovery current		-	7	-	A

2.1 Electrical characteristics (curves), based on HiP247 package option

Figure 1. Safe operating area

Figure 2. Thermal impedance

Figure 3. Output characteristics ($T_J = 25\text{ °C}$)

Figure 4. Output characteristics ($T_J = 175\text{ °C}$)

Figure 5. Transfer characteristics

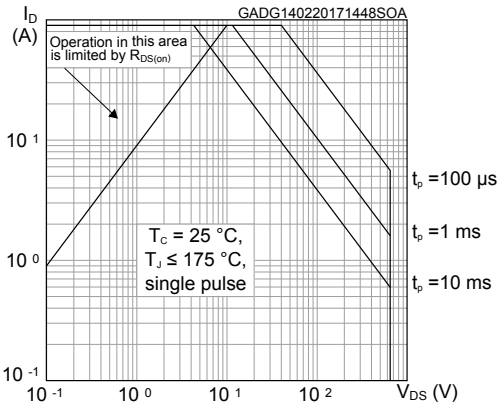
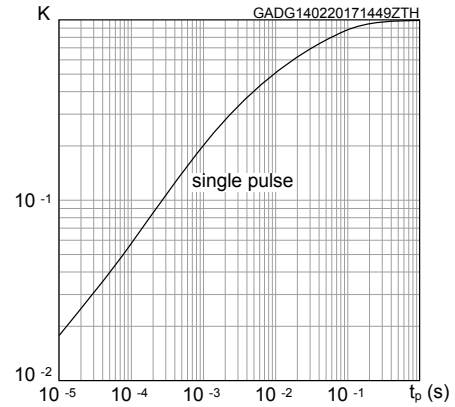
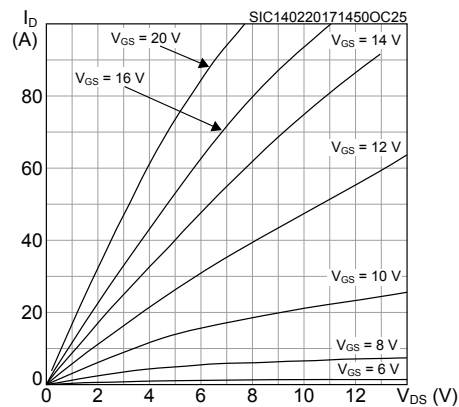
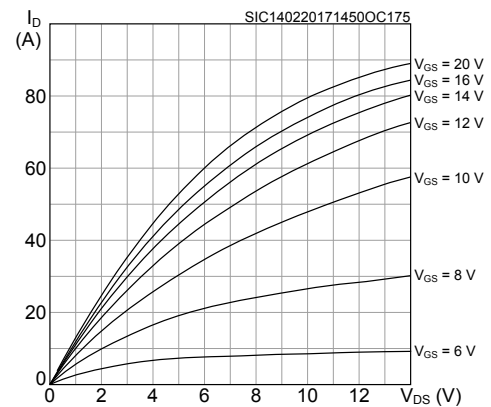
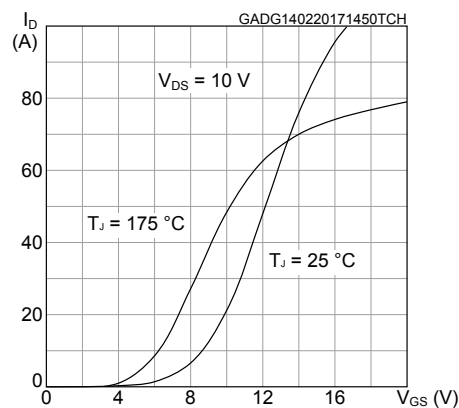
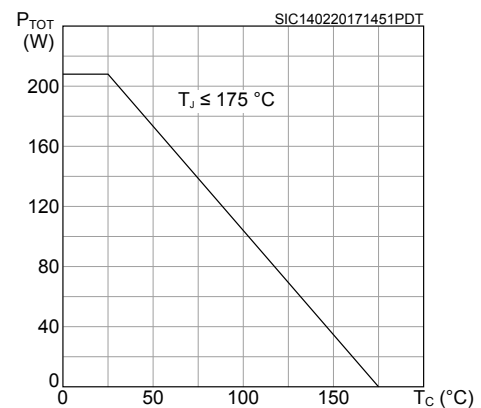
Figure 6. Total power dissipation

Figure 7. Gate charge vs gate-source voltage

Figure 8. Capacitance variations

Figure 9. Switching energy vs. drain current

Figure 10. Switching energy vs. junction temperature

Figure 11. Normalized $V_{(BR)DSS}$ vs. temperature

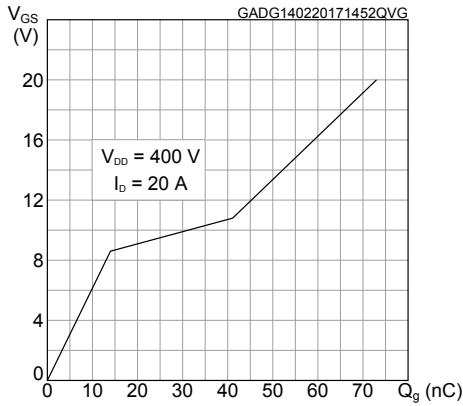
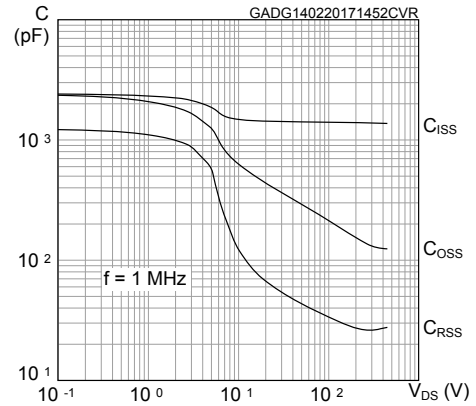
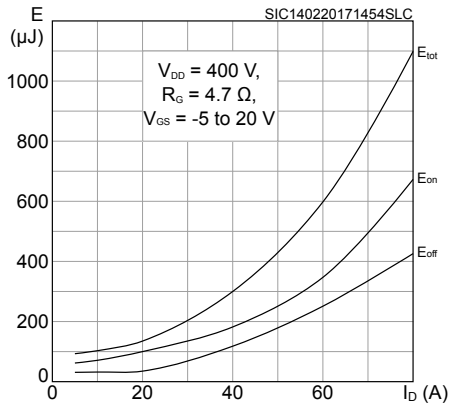
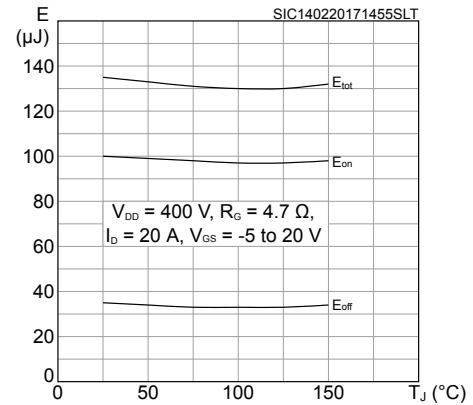
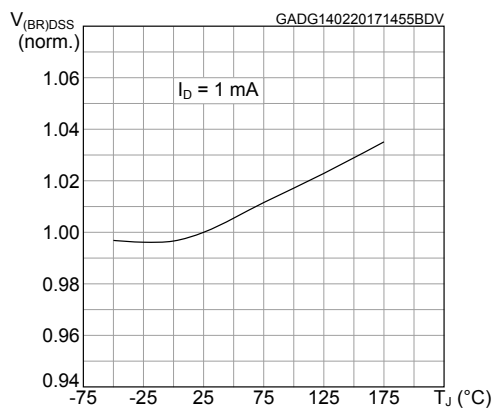
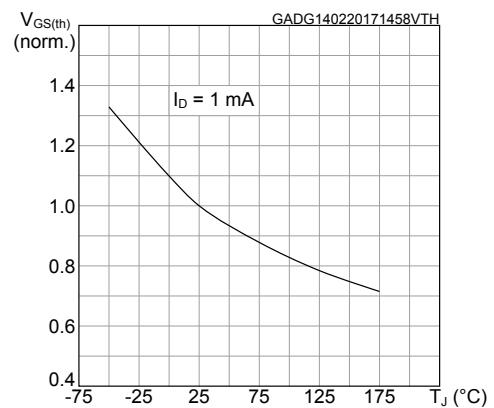
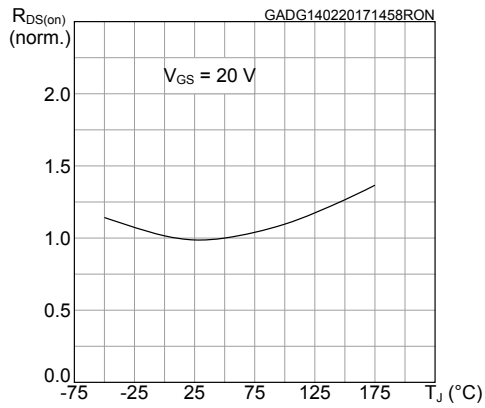
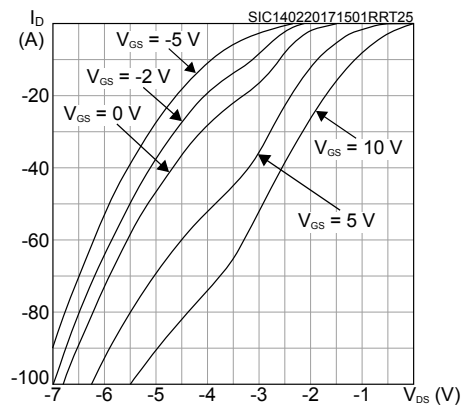
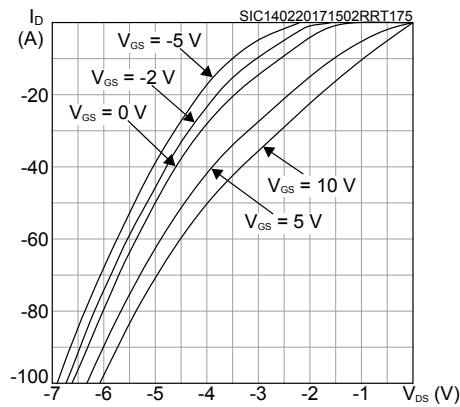
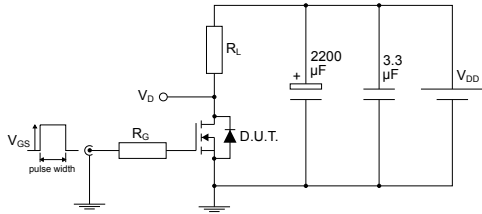
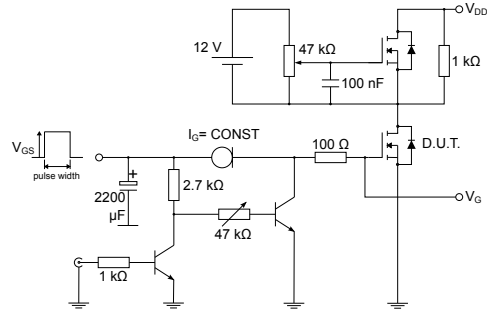
Figure 12. Normalized gate threshold voltage vs. temperature

Figure 13. Normalized on-resistance vs. temperature

Figure 14. Reverse conduction characteristics ($T_J = 25$ °C)

Figure 15. Reverse conduction characteristics ($T_J = 175$ °C)

3 Test circuits

Figure 16. Test circuit for resistive load switching times

AM01468v1

Figure 17. Test circuit for gate charge behavior

AM01469v1

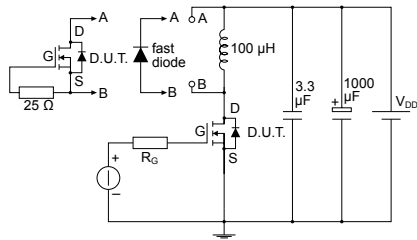
Figure 18. Test circuit for inductive load switching and diode recovery times

AM01470v1

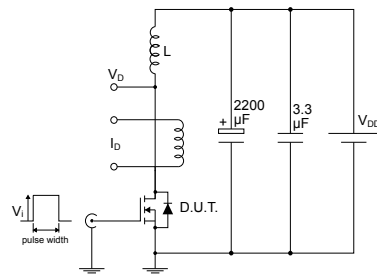
Figure 19. Unclamped inductive load test circuit

AM01471v1

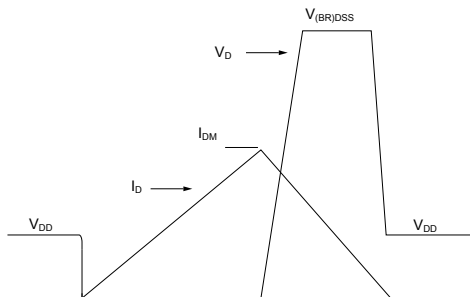
Figure 20. Unclamped inductive waveform

AM01472v1

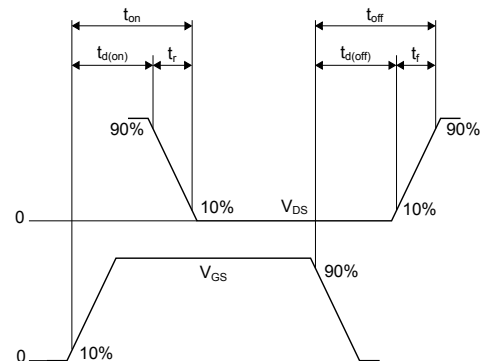
Figure 21. Switching time waveform

AM01473v1

4 Package information

In order to meet environmental requirements, ST offers these devices in different grades of **ECOPACK** packages, depending on their level of environmental compliance. ECOPACK specifications, grade definitions and product status are available at: www.st.com. ECOPACK is an ST trademark.

4.1 H²PAK-7 package information

Figure 22. H²PAK-7 package outline

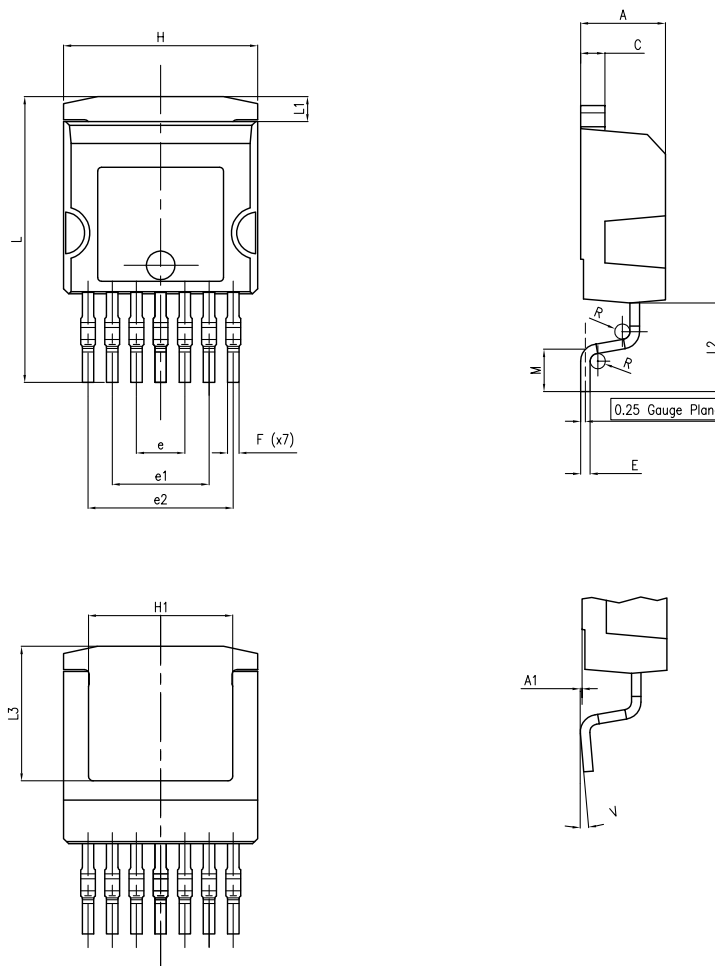
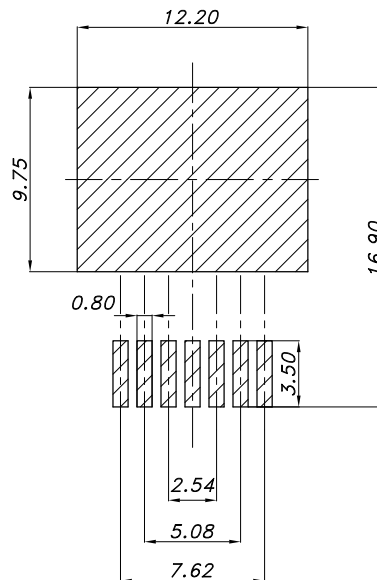

Table 8. H²PAK-7 package mechanical data

Dim.	mm	
	Min.	Max.
A	4.30	4.80
A1	0.03	0.20
C	1.17	1.37
e	2.34	2.74
e1	4.88	5.28
e2	7.42	7.82
E	0.45	0.60
F	0.50	0.70
H	10.00	10.40
H1	7.40	7.60
L	14.75	15.25
L1	1.27	1.40
L2	4.35	4.95
L3	6.85	7.25
M	1.90	2.50
R	0.20	0.60
V	0°	8°

Figure 23. H²PAK-7 recommended footprint



footprint_DM00249216_4

Note: Dimensions are in mm.

4.2 Packing information

Figure 24. Tape outline

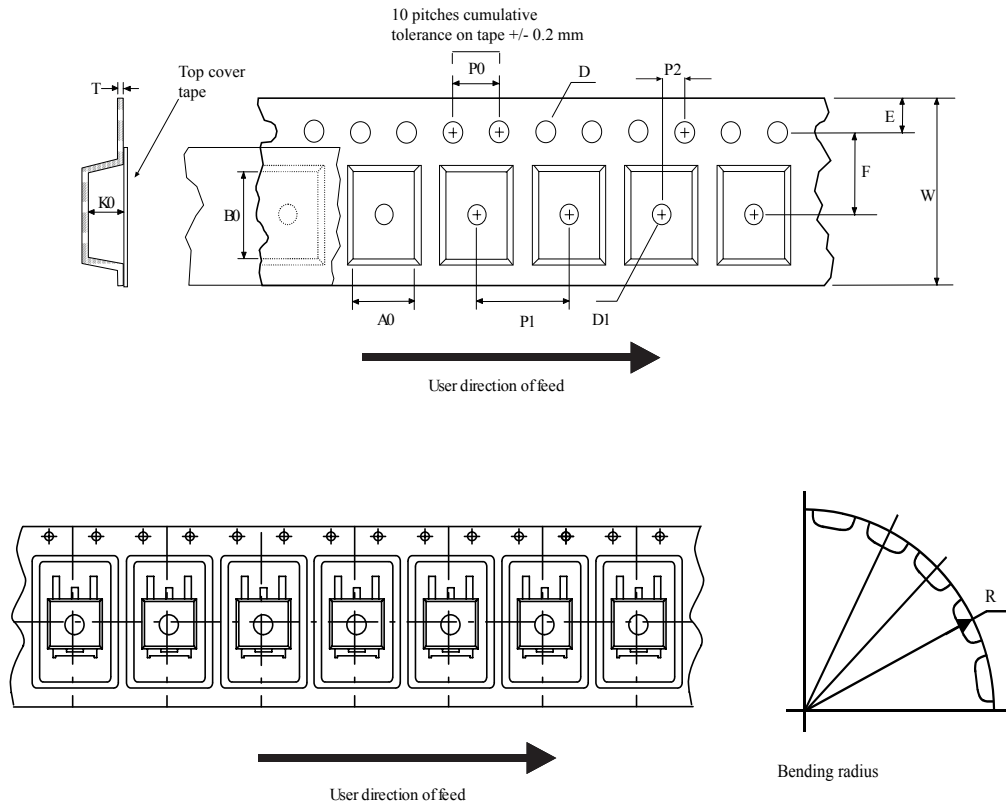

AM08852v2

Figure 25. Reel outline

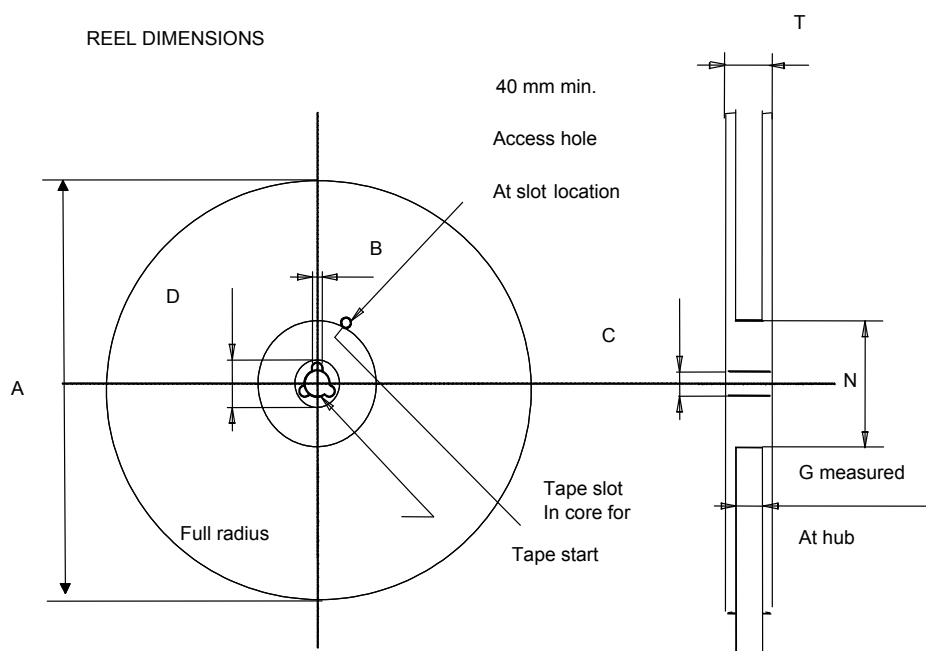

Table 9. Tape and reel mechanical data

Tape			Reel		
Dim.	mm		Dim.	mm	
	Min.	Max.		Min.	Max.
A0	10.5	10.7	A		330
B0	15.7	15.9	B	1.5	
D	1.5	1.6	C	12.8	13.2
D1	1.59	1.61	D	20.2	
E	1.65	1.85	G	24.4	26.4
F	11.4	11.6	N	100	
K0	4.8	5.0	T		30.4
P0	3.9	4.1			
P1	11.9	12.1	Base quantity		1000
P2	1.9	2.1	Bulk quantity		1000
R	50				
T	0.25	0.35			
W	23.7	24.3			

Revision history

Table 10. Document revision history

Date	Revision	Changes
27-Feb-2017	1	First release.
12-Dec-2017	2	Modified title. Modified <i>Table 4: "On/off states"</i> . Minor text changes.
03-Oct-2019	3	Updated title, Features and Description in cover page. Minor text changes.
09-Jan-2020	4	Updated <i>Table 1. Absolute maximum ratings</i> . Minor text changes.
17-Dec-2020	5	Updated <i>Table 7. Reverse SiC diode characteristics</i> . Minor text changes.

Contents

1	Electrical ratings	2
2	Electrical characteristics	3
2.1	Electrical characteristics (curves), based on HiP247 package option	5
3	Test circuits	8
4	Package information	9
4.1	H ² PAK-7 package information	9
4.2	Packing information	11
	Revision history	13

IMPORTANT NOTICE – PLEASE READ CAREFULLY

STMicroelectronics NV and its subsidiaries (“ST”) reserve the right to make changes, corrections, enhancements, modifications, and improvements to ST products and/or to this document at any time without notice. Purchasers should obtain the latest relevant information on ST products before placing orders. ST products are sold pursuant to ST’s terms and conditions of sale in place at the time of order acknowledgement.

Purchasers are solely responsible for the choice, selection, and use of ST products and ST assumes no liability for application assistance or the design of Purchasers’ products.

No license, express or implied, to any intellectual property right is granted by ST herein.

Resale of ST products with provisions different from the information set forth herein shall void any warranty granted by ST for such product.

ST and the ST logo are trademarks of ST. For additional information about ST trademarks, please refer to www.st.com/trademarks. All other product or service names are the property of their respective owners.

Information in this document supersedes and replaces information previously supplied in any prior versions of this document.

© 2020 STMicroelectronics – All rights reserved