

Preliminary Datasheet

FEATURES:

- Integrated Gate Driver
 - Low Propagation Delay
 - Up to 7 MHz Operation
 - Operates from 5 V Supply
- 200 V, 40-mΩ eGaN FET
- Low Inductance 2.9 mm x 1.1 mm BGA

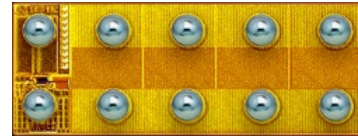

EPC2112 devices are supplied only in passivated die form with solder balls

Die Size: 2.9 mm x 1.1 mm

APPLICATIONS:

- Wireless Power (Highly Resonant and Inductive)
- High Frequency DC-DC Conversion

Schematic Diagram

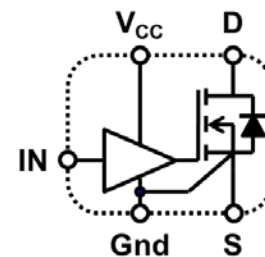

DESCRIPTION

The EPC2112 enhancement-mode gallium-nitride (eGaN®) integrated driver and FET consists of a 40-mΩ, 200 V eGaN power transistor and an optimized gate driver in a low inductance 2.9 mm by 1.1 mm surface-mount BGA.

The EPC2112 monolithic IC enables designers to improve efficiency, save space, and lower costs compared to silicon-based solutions. The ultra-low capacitance and zero reverse recovery of the eGaN FET enables efficient operation in many topologies. The integrated driver is specifically matched to the GaN device to yield optimal performance under various operating conditions. Performance further enhanced due to the small, low inductance footprint. Monolithic integration eliminates interconnect inductances for higher efficiency at high frequency. This is especially important for high frequency applications such as resonant wireless power.

ABSOLUTE MAXIMUM RATINGS

Maximum Ratings			
V _{DS}	Drain-to-Source Voltage (Continuous)	200	V
I _D	Continuous (T _A = 25°C, R _{θJA} = 18 °C/W)	10	A
	Pulsed (25°C, T _{PULSE} 300 μs)	40	
V _{IN}	Input Signal Voltage	6	V
T _J	Operating Temperature	-40 to 150	°C
T _{STG}	Storage Temperature	-40 to 150	
V _{CC}	Supply Voltage	6	V

RECOMMENDED OPERATING CONDITIONS

Recommended Operating Conditions					
PARAMETER	Description	MIN	TYP	MAX	UNIT
V _{DS}	Drain-Source voltage			160	V
V _{CC}	Driver Supply voltage	4.5	5	5.5	V
I _{CC}	External driver supply current ¹			50	mA
V _{IN,Off}	Input signal for turn-off			0.5	v
V _{IN,On}	Input signal for turn-on	4.5			V
V _{IN,slew}	Input signal slew rate	0.25			V/ns
T _J	Operating Temperature	-40		150	°C

¹ For up to maximum operating frequency

THERMAL INFORMATION

Thermal Characteristics			
		TYP	Unit
R _{θJC}	Thermal Resistance, Junction to Case	1.7	°C/W
R _{θJB}	Thermal Resistance, Junction to Board	20	°C/W
R _{θJA}	Thermal Resistance, Junction to Ambient ²	66	°C/W

² R_{θJA} is determined with the device mounted on one square inch of copper pad, single layer 2 oz copper on FR4 board. Thermal models for EPC devices available at <http://epc-co.com/epc/DesignSupport/DeviceModels.aspx>

EPC2112 – 200 V, 10 A Integrated Gate Driver eGaN® IC



ELECTRICAL CHARACTERISTICS

PARAMETER	TEST CONDITIONS	MIN	TYP	MAX	Unit
eGaN POWER TRANSISTOR					
BV_{DSS}	Drain-to-Source Voltage	$V_{CC} = 0\text{ V}, V_{IN} = 0\text{ V}, I_D = 125\ \mu\text{A}$		200	V
I_{DSS}	Drain -Source Leakage	$V_{DS} = 160\text{ V}, T_J = 25\text{ }^\circ\text{C}$		20	μA
$R_{DS(ON)}$	Drain-Source On-Resistance	$V_{CC} = 5\text{ V}, T_J = 25\text{ }^\circ\text{C}$		32	$\text{m}\Omega$
V_{SD}	Source-Drain Forward Voltage	$V_{CC} = 5\text{ V}, V_{IN} = 0\text{ V}, I_{SD} = 0.5\text{ A}$		2	V
C_{OSS}	Output Capacitance	$V_{IN} = 0\text{ V}, V_{CC} = 5\text{ V}, V_{DS} = 100\text{ V}, f = 1\text{ MHz}$		150	pF
$C_{OSS(ER)}$	Energy Output Capacitance, Energy Related ³	$V_{IN} = 0\text{ V}, V_{CC} = 5\text{ V}, V_{DS} = 0\text{ to }100\text{ V}$		175	
$C_{OSS(TR)}$	Energy Output Capacitance, Energy Related ⁴			233	
Q_{OSS}	Output Charge	$V_{IN} = 0\text{ V}, V_{CC} = 5\text{ V}, V_{DS} = 100\text{ V}, V_{GS} = 0\text{ V}$		24	nC
Q_{RR}	Source-Drain Recovery Charge			0	
³ $C_{OSS(ER)}$ is a fixed capacitance that gives the same stored energy as C_{OSS} while V_{DS} is rising from 0 to 50% BV_{DSS}					
⁴ $C_{OSS(TR)}$ is a fixed capacitance that gives the same charging time as C_{OSS} while V_{DS} is rising from 0 to 50% BV_{DSS}					

ELECTRICAL CHARACTERISTICS

PARAMETER	TEST CONDITIONS	MIN	TYP	MAX	Unit
DRIVER SUPPLY					
$I_{VCC,ON}$	Quiescent current (average)	$V_{IN} = 5\text{ V}, V_{CC} = 5\text{ V}, V_{DS} = 0\text{ V}$		4	mA
$I_{VCC,OFF}$	Quiescent current (average)	$V_{IN} = 0\text{ V}, V_{CC} = 5\text{ V}, V_{DS} = 0\text{ V}$		4	
$I_{VCC,OP}$	Operating Current	50% duty cycle, $V_{CC} = 5\text{ V}, f_{SW} = 1\text{ MHz}$		6.5	
V_{IH}	Turn-on Input pin, logic high	$V_{CC} = 5\text{ V}$		4.0	V
V_{IL}	Turn-off Input pin, logic low	$V_{CC} = 5\text{ V}$		0.7	

SWITCHING CHARACTERISTICS

Switching Characteristics					
PARAMETER	TEST CONDITIONS	MIN	TYP	MAX	UNIT
DRIVER⁵					
$t_{pd,on}$	Propagation delay, turn on	$V_{CC} = 5\text{ V}, V_{DS} = 160\text{ V}, I_L = 4\text{ A}$	2.7		ns
t_{rise}	Rise Time		2.7		ns
t_{on}	Total turn-on time		8.5		ns
$t_{pd,off}$	Propagation delay, turn off		16.9		ns
t_{fall}	Fall Time		5.5		ns
t_{off}	Total turn-off time		26.5		ns
t_{MIN}	Minimum on-time	$V_{CC} = 5\text{ V}, V_{BUS} = 160\text{ V}$		9.2	ns
t_{MAX}	Maximum on-time	$V_{CC} = 5\text{ V}, I_{DS} = 0.5\text{ A}$		40	ms

⁵See application circuit, Figure 4 & 5

TYPICAL CHARACTERISTICS

Figure 1: Normalized On-State Resistance vs Temperature

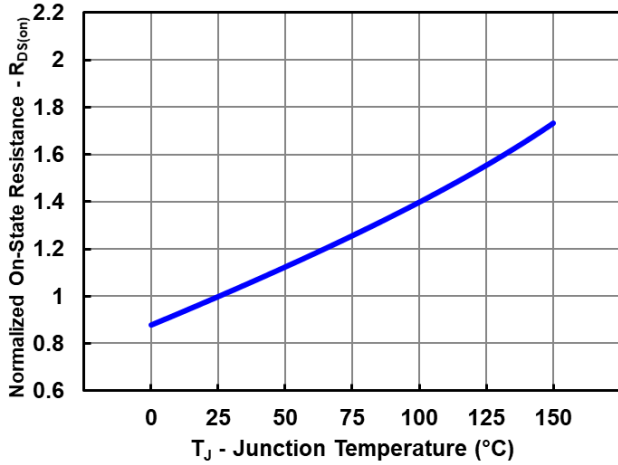

Figure 2: Capacitance (Linear Scale)

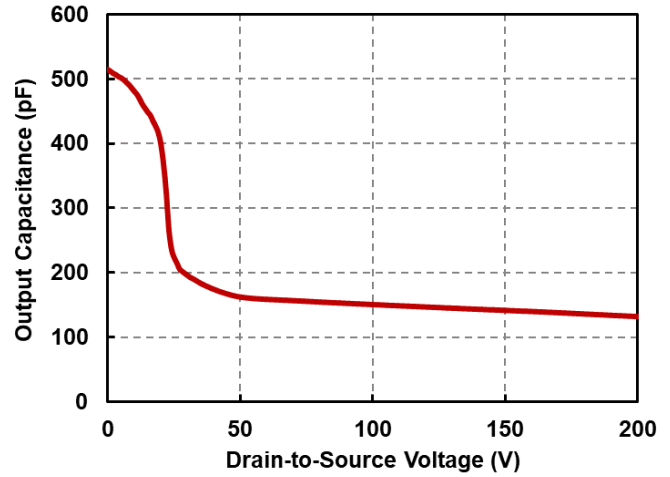

Figure 3: Output Charge and C_{oss} Stored Energy

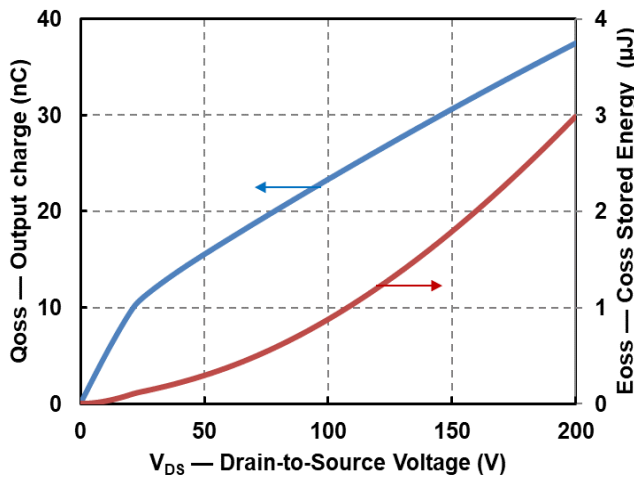

Figure 4: Double pulse Test Definitions

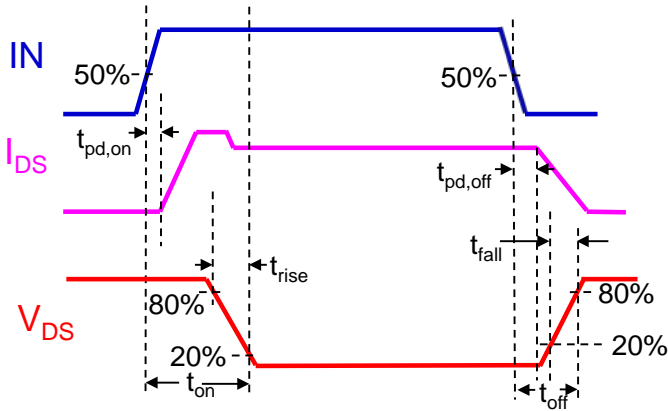

Figure 5: Double pulse Test Circuit

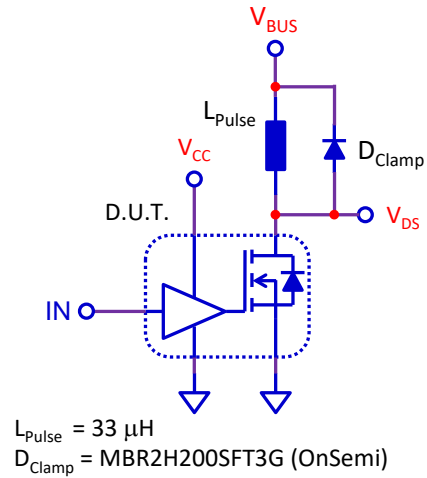

Figure 6: Driver quiescent current as function of frequency

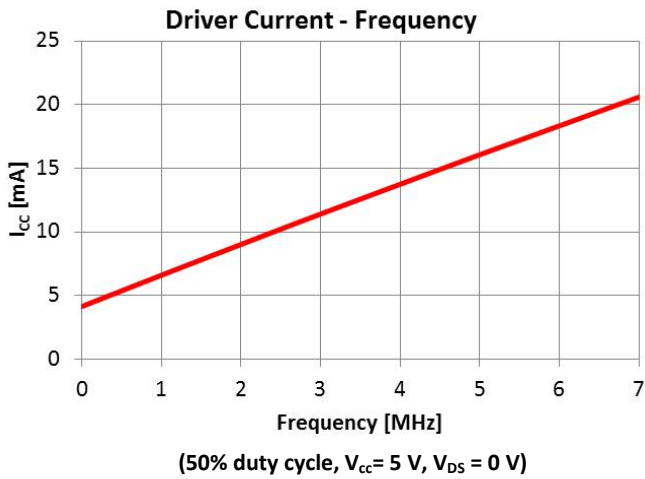
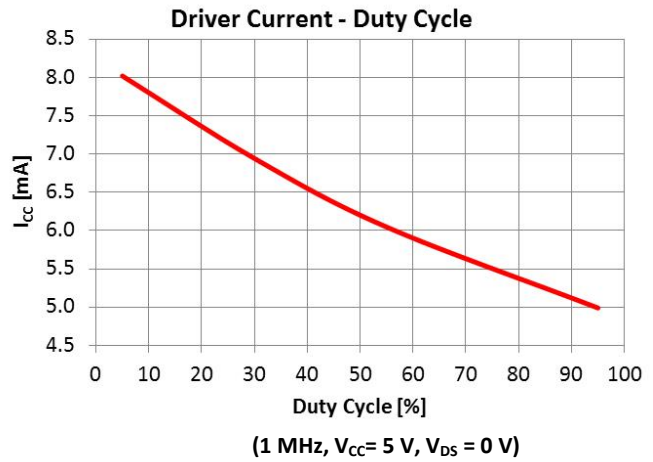

Figure 7: Driver quiescent current as function of duty cycle



EPC2112 – 200 V, 10 A Integrated Gate Driver eGaN® IC



DIE MARKINGS

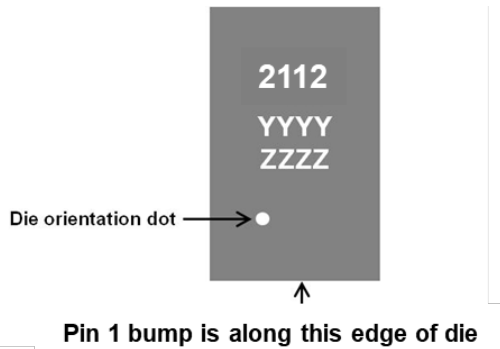

Part Number	Laser Marking		
	Part # Marking Line 1	Lot Date Code Marking Line 2	Lot Date Code Marking Line 3
EPC2112ENGRT	2112	YYYY	ZZZZ

DIE OUTLINE

Solder Bump View

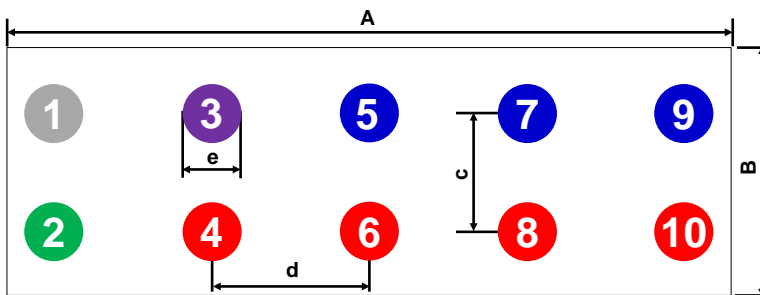

DIM	MICROMETERS		
	MIN	Nominal	MAX
A	2870	2900	2930
B	1070	1100	1130
c		600	
d		600	
e	238	264	290

- Pad 1 is Input;
- Pad 2 is V_{CC} ;
- Pad 3 is Gnd;
- Pads 4, 6, 8, 10 are Drain;
- Pads 5, 7, 9 are Source

Side View

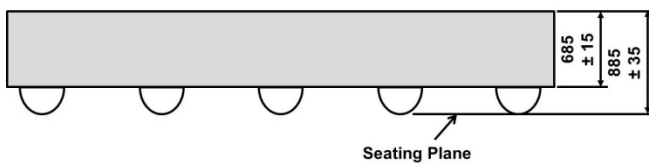

RECOMMENDED LAND PATTERN

(Units in μm)

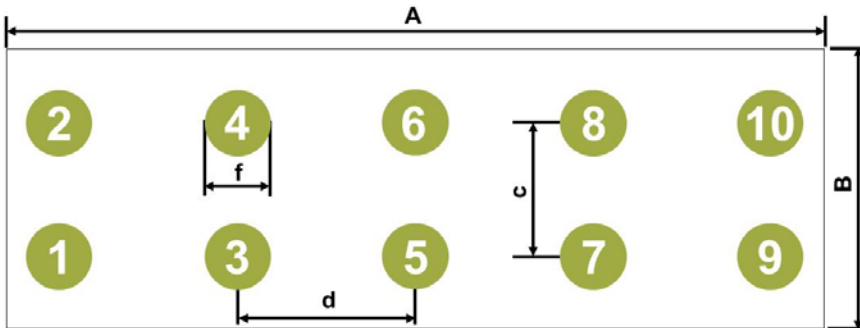

DIM	MICROMETERS
A	2900
B	1100
c	600
d	600
f	230

The land pattern is solder mask defined. Copper is larger than the solder mask opening.

RECOMMENDED STENCIL DESIGN

(Units in μm)

Back Side View (Bump on Bottom)

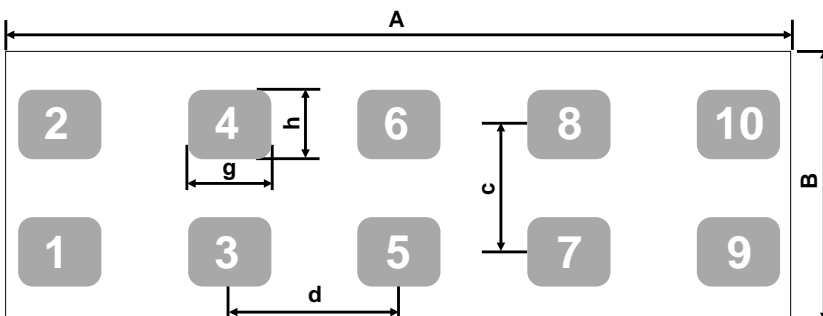

DIM	MICROMETERS
A	2900
B	1100
c	600
d	600
g	300
h	250

Intended for use with SAC305 Type 4 solder, reference 88.5% metals content.

Recommended stencil should be 4mil (100 μm) thick, laser cut. The corner has a radius of R60.

Additional assembly resources available at <http://epc-co.com/epc/DesignSupport/AssemblyBasics.aspx>

Efficient Power Conversion Corporation (EPC) reserves the right to make changes without further notice to any products herein. Preliminary specification sheet contains information regarding a product EPC is considering for production release. EPC does not assume any liability arising out of the application or use of any product or circuit described herein; neither does it convey any license under its patent rights, nor the rights of other.

eGaN[®] is a registered trademark of Efficient Power Conversion Corporation.

EPC Patents: <http://epc-co.com/epc/AboutEPC/Patents.aspx>

March, 2018