

HEIDI-D

~10° diffused spot beam optimized for LUXEON Rebel ES

SPECIFICATION:

Dimensions	Ø 21.6 mm
Height	11.7 mm
Fastening	tape, pin
ROHS compliant	yes ⓘ



MATERIALS:

Component	Type	Material	Colour	Finish
HEIDI-D	Single lens	PMMA	clear	
HEIDI-TAPE	Tape	Acrylic foam	black	

ORDERING INFORMATION:

Component		Qty in box	MOQ	MPQ	Box weight (kg)
CA12530_HEIDI-D	Single lens	3264	204	204	10.3
» Box size: 480 x 280 x 300 mm					

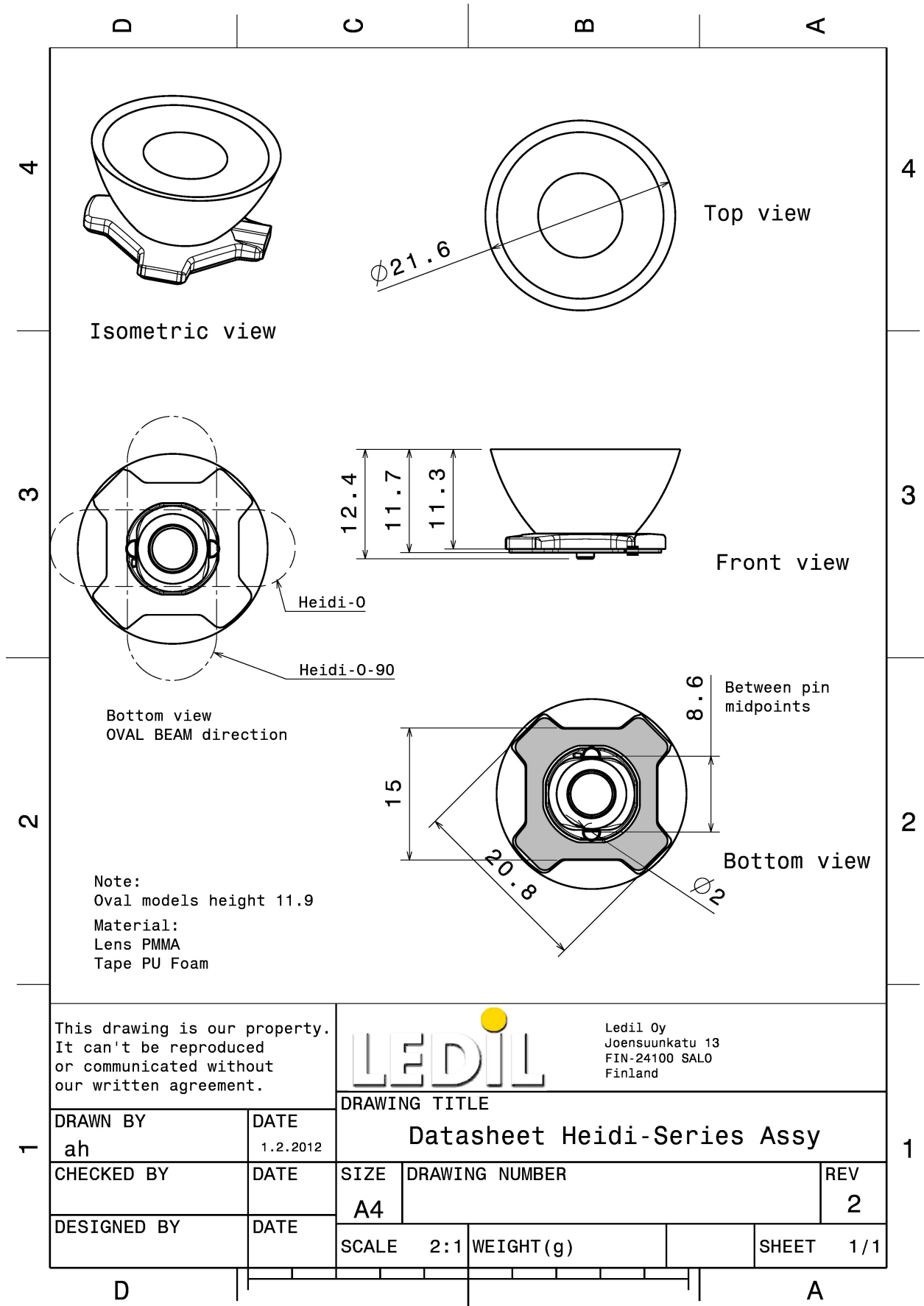

See also our general installation guide: www.ledil.com/installation_guide

OPTICAL RESULTS (MEASURED):

CREE LED

LED XHP35 HD
 FWHM / FWTM 20.0° / 46.0°
 Efficiency 83 %
 Peak intensity 4.2 cd/m
 LEDs/each optic 1
 Light colour White
 Required components:

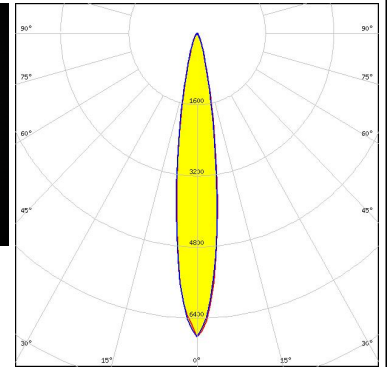

CREE LED

LED XHP35 HI
 FWHM / FWTM 17.0° / 38.0°
 Efficiency 94 %
 Peak intensity 5.7 cd/m
 LEDs/each optic 1
 Light colour White
 Required components:

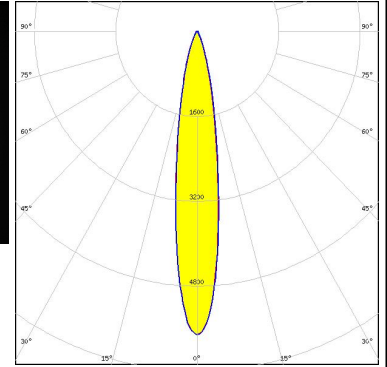
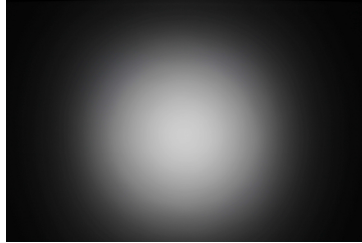

CREE LED

LED XP-G2
 FWHM / FWTM 15.0° / 36.0°
 Efficiency 94 %
 Peak intensity 6.6 cd/m
 LEDs/each optic 1
 Light colour White
 Required components:

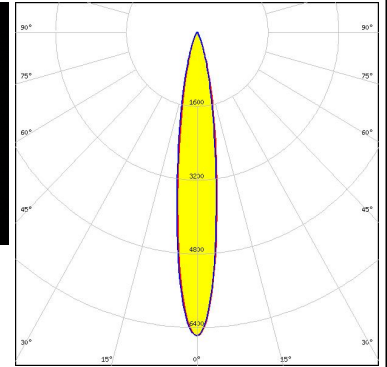
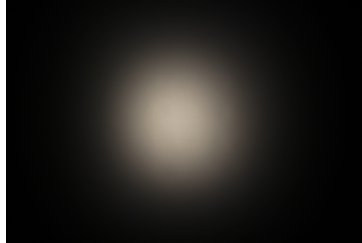

CREE LED

LED XP-G3
 FWHM / FWTM 17.0° / 40.0°
 Efficiency 94 %
 Peak intensity 5.1 cd/m
 LEDs/each optic 1
 Light colour White
 Required components:

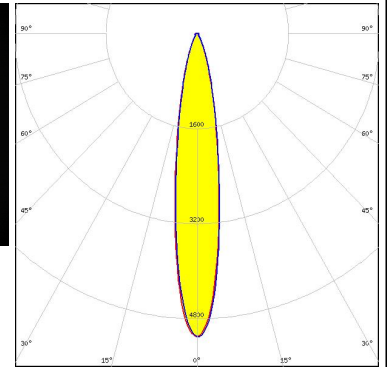

OPTICAL RESULTS (MEASURED):



LED XP-L HD
 FWHM / FWTM 18.0° / 41.0°
 Efficiency 85 %
 Peak intensity 4.8 cd/lm
 LEDs/each optic 1
 Light colour White
 Required components:

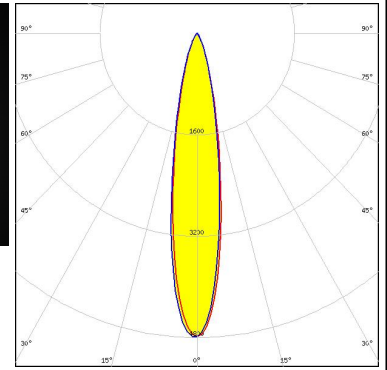
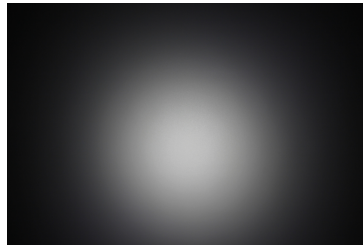

LED XT-E
 FWHM / FWTM 14.0° / 32.0°
 Efficiency 94 %
 Peak intensity 7.9 cd/lm
 LEDs/each optic 1
 Light colour White
 Required components:

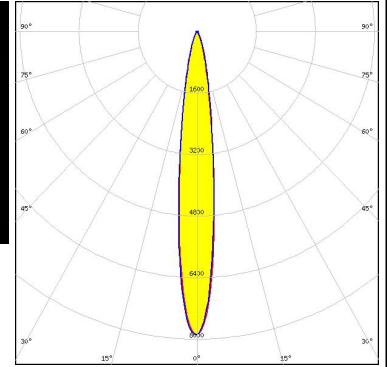
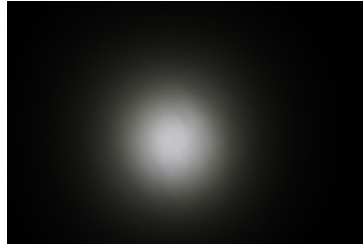

LED LUXEON A
 FWHM / FWTM 12.0° / 26.0°
 Efficiency 86 %
 Peak intensity 10 cd/lm
 LEDs/each optic 1
 Light colour White
 Required components:



LED LUXEON Rebel
 FWHM / FWTM 14.0° / 34.0°
 Efficiency 86 %
 Peak intensity 7.5 cd/lm
 LEDs/each optic 1
 Light colour White
 Required components:

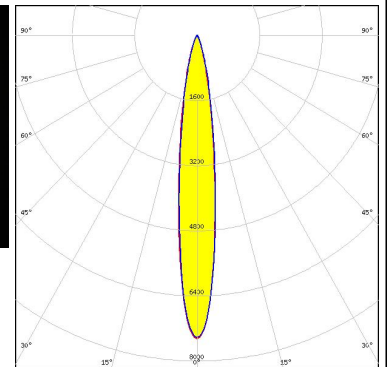

OPTICAL RESULTS (MEASURED):

LUMILEDS

LED LUXEON Rebel ES
 FWHM / FWTM 15.0° / 36.0°
 Efficiency 91 %
 Peak intensity 6.5 cd/m
 LEDs/each optic 1
 Light colour White
 Required components:

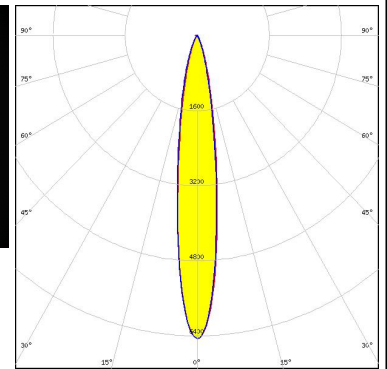
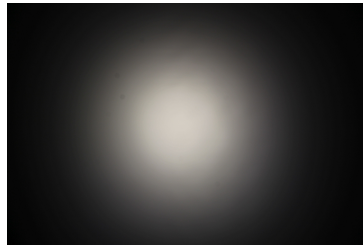

LUMINUS

LED SST-10-B130
 FWHM / FWTM 14.0° / 32.0°
 Efficiency 93 %
 Peak intensity 7.9 cd/m
 LEDs/each optic 1
 Light colour Blue
 Required components:

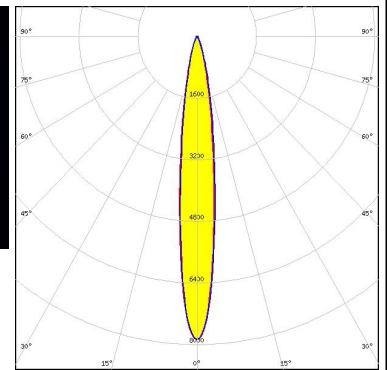

NICHIA

LED NVSW219D
 FWHM / FWTM 16.0° / 39.0°
 Efficiency 94 %
 Peak intensity 5.8 cd/m
 LEDs/each optic 1
 Light colour White
 Required components:

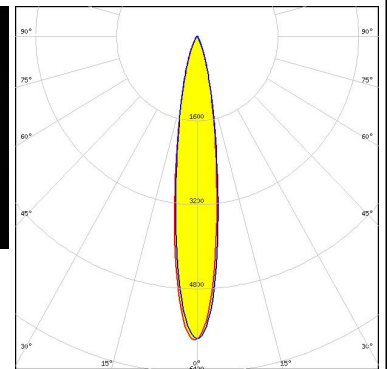
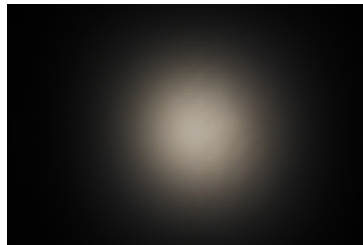



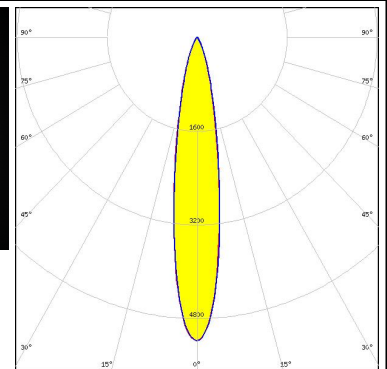
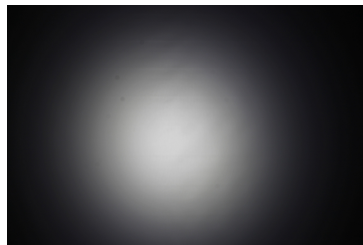

NICHIA



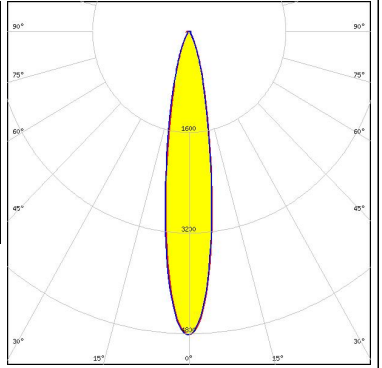

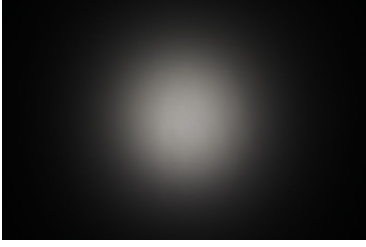
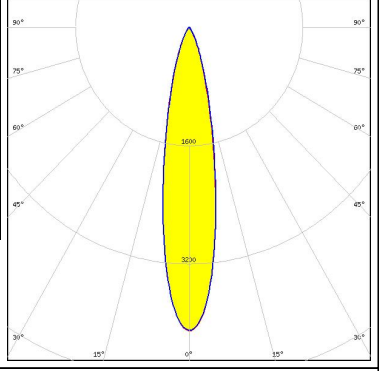
LED NVSW319B
 FWHM / FWTM 18.0° / 41.0°
 Efficiency 93 %
 Peak intensity 5.2 cd/m
 LEDs/each optic 1
 Light colour White
 Required components:

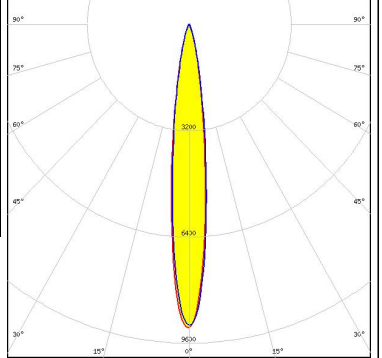

OPTICAL RESULTS (MEASURED):

<p>NICHIA</p> <p>LED NVSW3x9A FWHM / FWTM 18.0° / 41.0° Efficiency 90 % Peak intensity 4.8 cd/lm LEDs/each optic 1 Light colour White Required components:</p>		
<p>NICHIA</p> <p>LED NVSW519A FWHM / FWTM 20.0° / 45.0° Efficiency 94 % Peak intensity 4.4 cd/lm LEDs/each optic 1 Light colour White Required components:</p>		
<p>NICHIA</p> <p>LED NWSx229A FWHM / FWTM 20.0° / 45.0° Efficiency 84 % Peak intensity 4.1 cd/lm LEDs/each optic 1 Light colour White Required components:</p>		
<p>OSRAM <small>Opto Semiconductors</small></p> <p>LED OSLOM SSL 150 FWHM / FWTM 13.0° / 30.0° Efficiency 87 % Peak intensity 9.1 cd/lm LEDs/each optic 1 Light colour White Required components:</p>		

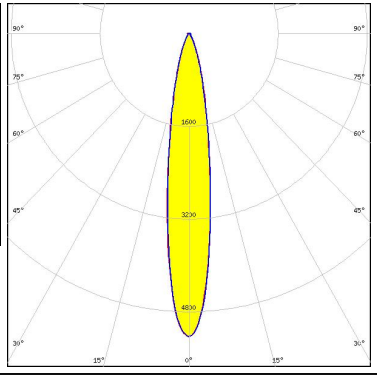
OPTICAL RESULTS (MEASURED):

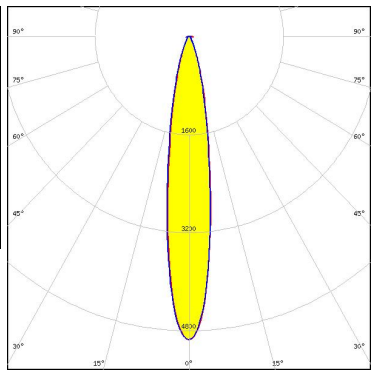
<p> SEOU SEMICONDUCTOR</p> <p>LED Z5M3</p> <p>FWHM / FWTM 17.0° / 40.0°</p> <p>Efficiency 94 %</p> <p>Peak intensity 5.2 cd/lm</p> <p>LEDs/each optic 1</p> <p>Light colour White</p> <p>Required components:</p>		
<p> SEOU SEMICONDUCTOR</p> <p>LED Z8Y22P</p> <p>FWHM / FWTM 17.0° / 39.0°</p> <p>Efficiency 92 %</p> <p>Peak intensity 5 cd/lm</p> <p>LEDs/each optic 1</p> <p>Light colour White</p> <p>Required components:</p>		

OPTICAL RESULTS (SIMULATED):



LED XP-G2 HE
 FWHM / FWTM 14.0° / 28.0°
 Efficiency 95 %
 Peak intensity 10.7 cd/lm
 LEDs/each optic 1
 Light colour White
 Required components:

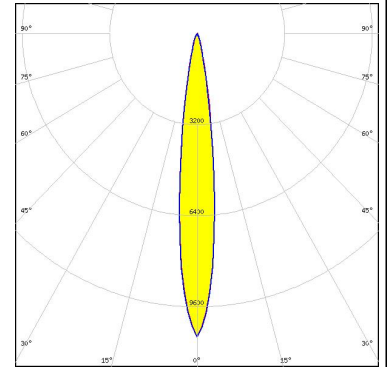

LED LUXEON HL2Z
 FWHM / FWTM 12.0° / 24.0°
 Efficiency 95 %
 Peak intensity 14.7 cd/lm
 LEDs/each optic 1
 Light colour White
 Required components:

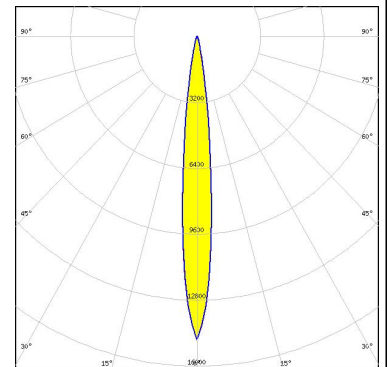

LED LUXEON R
 FWHM / FWTM 12.0° / 26.0°
 Efficiency %
 LEDs/each optic 1
 Light colour White
 Required components:



LED LUXEON SunPlus 20 Line (120 deg)
 FWHM / FWTM 9.0° / 18.0°
 Efficiency 96 %
 Peak intensity 26.1 cd/lm
 LEDs/each optic 1
 Light colour White
 Required components:

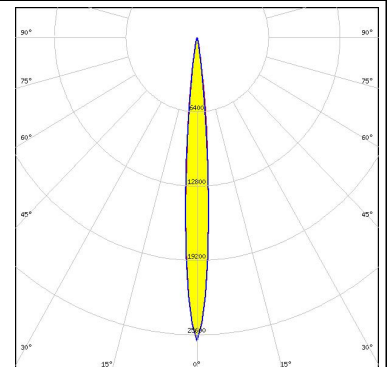

OPTICAL RESULTS (SIMULATED):

LUMILEDS

LED LUXEON SunPlus 20 Line (150 deg)
 FWHM / FWTM 8.0° / 18.0°
 Efficiency 92 %
 Peak intensity 24.9 cd/lm
 LEDs/each optic 1
 Light colour White
 Required components:

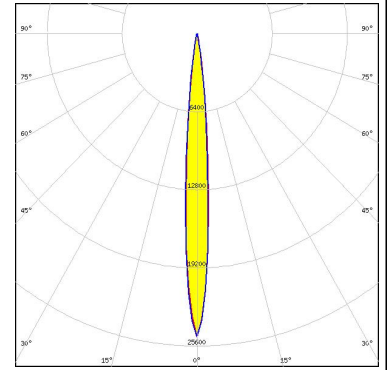

LUMILEDS

LED LUXEON SunPlus 20 Line (150 deg)
 FWHM / FWTM 8.7° / 18.0°
 Efficiency 93 %
 Peak intensity 25.6 cd/lm
 LEDs/each optic 1
 Light colour White
 Required components:

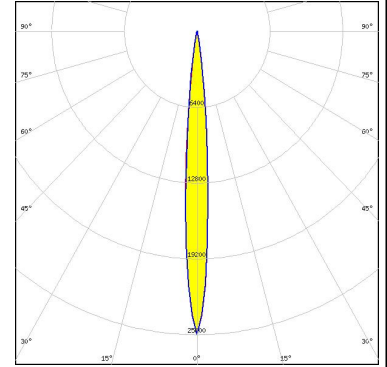

LUMILEDS

LED LUXEON SunPlus 35 Line
 FWHM / FWTM 8.5° / 18.0°
 Efficiency 94 %
 Peak intensity 27.2 cd/lm
 LEDs/each optic 1
 Light colour White
 Required components:

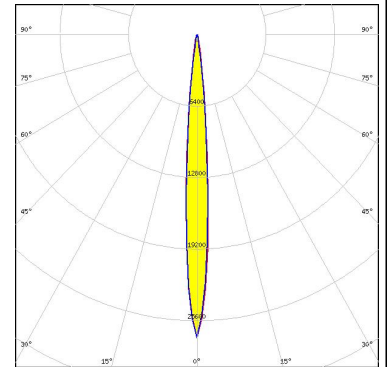

LUMILEDS

LED LUXEON Z ES
 FWHM / FWTM 10.0° / 21.0°
 Efficiency 94 %
 Peak intensity 20.5 cd/lm
 LEDs/each optic 1
 Light colour White
 Required components:

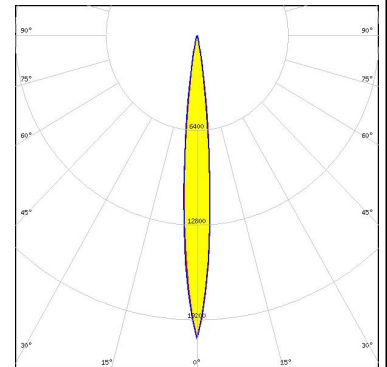

OPTICAL RESULTS (SIMULATED):

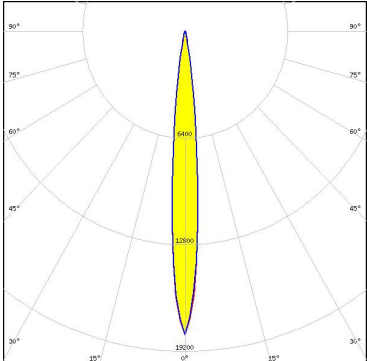
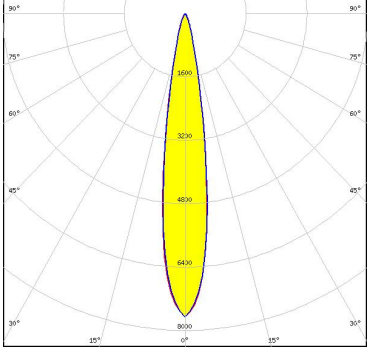
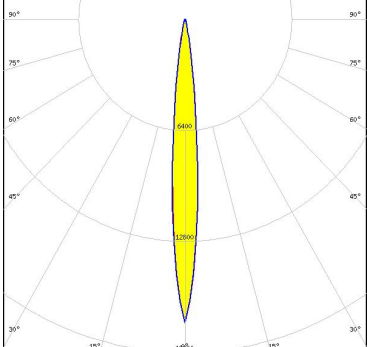
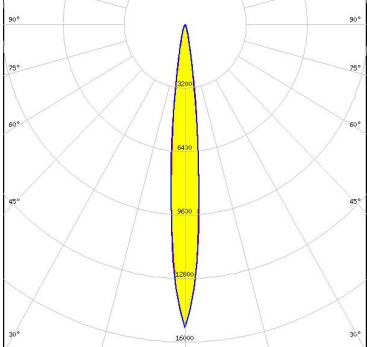
<p>NICHIA</p> <p>LED: NCSxE17A FWHM / FWTM: 10.0° / 20.0° Efficiency: 92 % Peak intensity: 18.2 cd/lm LEDs/each optic: 1 Light colour: White Required components:</p>	
<p>NICHIA</p> <p>LED: NV4WB35AM FWHM / FWTM: 16.0° / 32.0° Efficiency: 96 % Peak intensity: 7.8 cd/lm LEDs/each optic: 1 Light colour: White Required components:</p>	
<p>NICHIA</p> <p>LED: NVSxE21A FWHM / FWTM: 10.0° / 22.0° Efficiency: 94 % Peak intensity: 17.5 cd/lm LEDs/each optic: 1 Light colour: White Required components:</p>	
<p>OSRAM <small>Opto Semiconductors</small></p> <p>LED: OSCONIQ P 3737 Flat FWHM / FWTM: 11.0° / 23.0° Efficiency: 97 % Peak intensity: 15.3 cd/lm LEDs/each optic: 1 Light colour: White Required components:</p>	

OPTICAL RESULTS (SIMULATED):

SAMSUNG

LED	LH351C
FWHM / FWTM	14.0° / 26.0°
Efficiency	96 %
Peak intensity	11.8 cd/lm
LEDs/each optic	1
Light colour	White
Required components:	

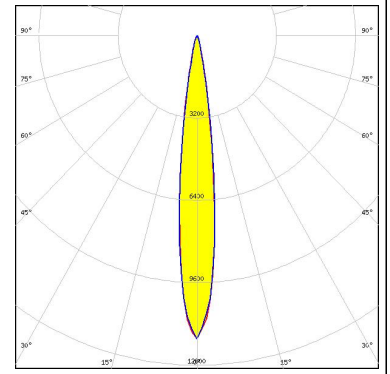

GENERAL INFORMATION:

NOTE: The typical beam angle will be changed by different color, chip size and chip position tolerance. The typical total beam angle is the full angle measured where the luminous intensity is half of the peak value.

MATERIALS:

As part of our continuous research and improvement processes, and to ensure the best possible quality and availability of our products, LEDiL reserves the right to change material grades without notice.

PRODUCT DATA USER AGREEMENT AND DISCLAIMER:

The measured data in the provided downloadable LEDiL Product Datasheets and Mechanical 2D-Drawings is rounded and provided as reference for planning. LEDiL Oy's optical specifications have been verified by conducting performance testing of the products in accordance with the company's quality system. The reported data are averaged results of multiple measurements with typical variation. LEDiL Oy reserves the right to without prior notification make changes and improvements to its products.

LEDiL Oy assumes neither warranty, nor guarantee nor any other liability of any kind for the contents and correctness of the provided data. The provided data has been generated with highest diligence but the provided data may in reality not represent the complete possible variation range of all intrinsic parameters. Therefore, in certain cases a deviation from the provided data could occur.

LEDiL Oy reserves the right to undertake technical changes of its products without further notification which could lead to changes in the provided data. LEDiL Oy assumes no liability of any kind for the possible deviation from any provided data or any other damage resulting from the usage of the provided data.

The user agrees to this disclaimer and user agreement with the download or usage of the provided files.

LEDiL Oy

Joensuunkatu 13
FI-24240 SALO
Finland

LEDiL Inc.

228 West Page Street
Suite D
Sycamore IL 60178
USA

Ledil Optics Technology (Shenzhen) Co., Ltd.

405 , Block B
Casic Motor Building
Shenzhen 518057
P.R.CHINA

Local sales and technical support

[www.ledil.com/
where_to_buy](http://www.ledil.com/where_to_buy)

Shipping locations

Salo, Finland
Hong Kong, China

Distribution Partners

[www.ledil.com/
where_to_buy](http://www.ledil.com/where_to_buy)