

## Item description

### Male connector/plug *WINSTA*® MINI 4-pole

Use effective pluggable connections instead of laborious screw connections: With the *WINSTA*® MINI male connector/plug B coding, WAGO pluggable installation connectors can be used when criteria repeat or are planned on a defined pattern, for example for installing grid lighting or flush-mount lighting. The mechanical coding and color coding of the pluggable installation connector ensure error-free installation of the individual components – including protection against mismatching. B coding enables the *WINSTA*® MINI pluggable installation connectors to be used for control in applications in automation, mechanical engineering and robotics. Especially where space is tight, our smallest pluggable connection system, *WINSTA*® MINI, consistently displays its strengths. It saves space, and, with Push-in CAGE CLAMP® spring pressure connection technology, it also saves time, since the installation is low-maintenance and can be performed without screw connections.

### Lower costs through fast commissioning and elimination of service expenses – solutions from *WINSTA*® MINI

*WINSTA*® is the pluggable connection system that is optimally tailored to the strict requirements of electrical installation. It ensures fast, secure and, above all, error-free installation of components and cables. Enjoy the benefits of the pluggable version of our maintenance-free spring pressure connection technology too! Plan your installation with *WINSTA*® MINI pluggable installation connectors with protection against mismatching from WAGO.

Subject to changes. Please also observe the further product documentation!



- 
- pluggable installation connectors with protection against mismatching
- consistent IP40 protection
- with B coding for use in process automation, such as lighting technology
- ready to install and use immediately
- convenient installation and commissioning

## Data

### Notes

Variants:

Other pole markings

Other versions (or variants) can be requested from WAGO Sales or configured at <https://configurator.wago.com/>.

### Electrical data

#### Ratings per IEC/EN

Ratings per	IEC/EN 60664-1
Nominal voltage (III/3)	400 V
Rated impulse voltage (III/3)	6 kV
Rated current	16 A
Note (rated current)	13 A for 3-pole load 10 A for 4-pole load
Legend (ratings)	(III / 3) ≙ Overvoltage category III / Pollution degree 3

#### Ratings per UL 1977

Note for the US market

Some versions may also be used for current interruption in accordance with the UL certificate in select applications with currents below 5 A and voltages up to 600 V. For further information, please contact your local sales office.

Rated voltage (UL 1977)	600 V
Rated current UL 1977	12 A

### General

Note on contact resistance

approx. 1 mΩ of contact resistance  
approx. 0.25 mΩ contact transition plug/socket

Subject to changes. Please also observe the further product documentation!



## Connection data

Connection points	4
Total number of potentials	4

## Connection 1

Connection technology	Push-in CAGE CLAMP®
Actuation type	Operating tool Push-in
Nominal cross-section	1.5 mm <sup>2</sup> / 16 AWG
Solid conductor	0.25 ... 1.5 mm <sup>2</sup> / 22 ... 16 AWG
Solid conductor; push-in termination	0.75 ... 1.5 mm <sup>2</sup> / 20 ... 16 AWG
Stranded conductor	0.25 ... 1 mm <sup>2</sup> / 22 ... 18 AWG
Fine-stranded conductor	0.25 ... 1.5 mm <sup>2</sup> / 22 ... 16 AWG
Fine-stranded conductor; with insulated ferrule	0.25 ... 0.75 mm <sup>2</sup> / 22 ... 20 AWG
Fine-stranded conductor; with uninsulated ferrule	0.25 ... 0.75 mm <sup>2</sup> / 22 ... 20 AWG
Fine-stranded conductor; with ferrule; push-in termination	0.75 mm <sup>2</sup> / 20 AWG
Strip length	9 mm / 0.35 inches
Pole number	4
Conductor entry direction to mating direction	0°

## Physical data

Pin spacing	4.4 mm / 0.173 inches
Width	19.2 mm / 0.756 inches
Height	11.7 mm / 0.461 inches
Depth	34.1 mm / 1.343 inches

## Mechanical Data

Application	Control technology
Coding	B
Variable coding	No
Marking	4 3 2 1
Potential marking	4 3 2 1
Mating force of a plug-in connection	approx. 20 ... 70 N (depending on pole number)
Retention force of a plug-in connection	Locked: > 80 N
Unmating force of a plug-in connection	Unlocked: approx. 20 ... 70 N (depending on pole number)

Subject to changes. Please also observe the further product documentation!



Number of mating cycles	200, without resistive load
Protection type	IP20; IP40 when mated with strain relief housing

### Plug-in connection

Contact type (pluggable connector)	Male connector/plug
Connector (connection type)	for conductor
Mismating protection	Yes
Note on mismating protection	All <i>WINSTA</i> <sup>®</sup> components are 100% protected against mismating when: a.) plugging different numbers of poles b.) plugging while rotated 180 c.) plugging while laterally staggered d.) plugging one pole
Locking lever	Can be retrofitted
Locking of plug-in connection	locking lever
Note on locking system	All connectors for mounted installations (snap-in versions for lighting fixtures or devices, all types of PCB and distribution connectors) are factory-equipped with locking levers to ensure plugs and sockets are securely locked. Additional locking levers are only required for flying leads (plug/socket).

### Material Data

Note (material data)	Information on material specifications can be found here
Color	pink
Cover color	gray
Material group	I
Insulation material	Polyamide (PA66)
Flammability class per UL94	V0
Clamping spring material	Chrome-nickel spring steel (CrNi)
Contact material	Copper or copper alloy; surface-treated
Contact plating	Tin
Fire load	0.113 MJ
Weight	4.6 g

### Environmental requirements

Processing temperature	-5 ... +40 °C
Continuous operating temperature	-35 ... +85 °C

Subject to changes. Please also observe the further product documentation!

Note on continuous operating temperature

Insulating parts for temperatures  $\leq 105\text{ }^{\circ}\text{C}$ 

## Commercial data

Product Group	20 (Winsta)
eCl@ss 10.0	27-44-06-05
eCl@ss 9.0	27-44-06-05
ETIM 8.0	EC002560
ETIM 7.0	EC002560
PU (SPU)	50 pcs
Packaging type	box
Country of origin	PL
GTIN	4055143523608
Customs tariff number	85366990990



## Environmental Product Compliance

RoHS Compliance Status

Compliant, No Exemption

## Approvals / Certificates

### General approvals

Logo	Approval	Additional Approval Text	Certificate name
	CB DEKRA Certification B.V.	EN 61984	71-112993
	CB DEKRA Certification B.V.	IEC 61984	NL-64351
	cURus Underwriters Laboratories Inc.	UL 1977	E45171
	KEMA/KEUR DEKRA Certification B.V.	EN 60320	2148952.04

## Declarations of conformity and manufacturer's declarations

Logo	Approval	Additional Approval Text	Certificate name
	EU-Declaration of Conformity	-	-

Subject to changes. Please also observe the further product documentation!





WAGO GmbH & Co. KG







UK-Declaration of Conformity

WAGO GmbH & Co. KG

Approvals for marine applications

Logo	Approval	Additional Approval Text	Certificate name
	<b>DNV GL</b> Det Norske Veritas, Germanischer Lloyd	-	TAE00001Z6
	<b>LR</b> Lloyds Register	EN 61535	08/20047 (E2)







Counterpart

	<b>Item no.890-1633</b> T-distribution connector; 4-pole; Cod. B; 1 input; 2 outputs; 2 locking levers; pink	<a href="http://www.wago.com/890-1633">www.wago.com/890-1633</a>
	<b>Item no.890-1683</b> h-distribution connector; 4-pole; Cod. B; 1 input; 2 outputs; outputs on one side; 2 locking levers; pink	<a href="http://www.wago.com/890-1683">www.wago.com/890-1683</a>
	<b>Item no.890-1733</b> T-distribution connector; 4-pole; Cod. B; 1 input; 2 outputs; 3 locking levers; for flying leads; pink	<a href="http://www.wago.com/890-1733">www.wago.com/890-1733</a>
	<b>Item no.890-1736</b> 3-way distribution connector; 4-pole; Cod. B; 1 input; 3 outputs; pink	<a href="http://www.wago.com/890-1736">www.wago.com/890-1736</a>
	<b>Item no.890-1783</b> h-distribution connector; 4-pole; Cod. B; 1 input; 2 outputs; outputs on one side; 3 locking levers; for flying leads; pink	<a href="http://www.wago.com/890-1783">www.wago.com/890-1783</a>

Subject to changes. Please also observe the further product documentation!

WAGO GmbH & Co. KG  
 Hansastr. 27  
 32423 Minden  
 Phone: +49571 887-0 | Fax: +49571 887-169  
 Email: [info.de@wago.com](mailto:info.de@wago.com) | Web: [www.wago.com](http://www.wago.com)





Do you have any questions about our products?  
 We are always happy to take your call at +49 (571) 887-44222.

	<b>Item no. 890-284</b> Socket; 4-pole; Cod. B; 1,50 mm <sup>2</sup> ; pink	<a href="http://www.wago.com/890-284">www.wago.com/890-284</a>
	<b>Item no. 890-784</b> Snap-in socket; 4-pole; Cod. B; 1,50 mm <sup>2</sup> ; pink	<a href="http://www.wago.com/890-784">www.wago.com/890-784</a>
	<b>Item no. 890-884</b> Socket for PCBs; straight; 4-pole; Cod. B; pink	<a href="http://www.wago.com/890-884">www.wago.com/890-884</a>
	<b>Item no. 891-8994/005-107</b> pre-assembled interconnecting cable; Eca; Socket/plug; 4-pole; Cod. B; Control cable 4 x 1.0 mm <sup>2</sup> ; 1 m; 1,00 mm <sup>2</sup> ; pink	<a href="http://www.wago.com/891-8994/005-107">www.wago.com/891-8994/005-107</a>
	<b>Item no. 890-884/011-000</b> Socket for PCBs; angled; 4-pole; Cod. B; pink	<a href="http://www.wago.com/890-884/011-000">www.wago.com/890-884/011-000</a>
	<b>Item no. 891-8994/105-107</b> pre-assembled connecting cable; Eca; Socket/open-ended; 4-pole; Cod. B; Control cable 4 x 1.0 mm <sup>2</sup> ; 1 m; 1,00 mm <sup>2</sup> ; pink	<a href="http://www.wago.com/891-8994/105-107">www.wago.com/891-8994/105-107</a>

## Required accessories



### Locking levers

#### Locking system

	<b>Item no.: 890-111</b> Locking lever; for flying leads; for tool operation; black	<a href="http://www.wago.com/890-111">www.wago.com/890-111</a>
	<b>Item no.: 890-101</b> Locking lever; for manual operation; black	<a href="http://www.wago.com/890-101">www.wago.com/890-101</a>
	<b>Item no.: 890-121</b> Locking lever; for manual operation; white	<a href="http://www.wago.com/890-121">www.wago.com/890-121</a>
	<b>Item no.: 890-131</b> Locking lever; for flying leads; for tool operation; white	<a href="http://www.wago.com/890-131">www.wago.com/890-131</a>

### Strain relief

#### Strain relief housing

	<b>Item no.: 890-504</b> Strain relief housing; 4-pole; with locking clip; for 1 cable; 6.5 ... 10.5 mm; 45 mm; black	<a href="http://www.wago.com/890-504">www.wago.com/890-504</a>
	<b>Item no.: 890-514</b> Strain relief housing; 4-pole; with locking clip; for 1 cable; 6.5 ... 10.5 mm; 45 mm; white	<a href="http://www.wago.com/890-514">www.wago.com/890-514</a>

Subject to changes. Please also observe the further product documentation!

## Optional accessories

### Tool

Operating tool



**Item no.: 210-719**

Operating tool; Blade: 2.5 x 0.4 mm; with a partially insulated shaft

[www.wago.com/210-719](http://www.wago.com/210-719)



**Item no.: 890-384**

Operating tool; 4-way; green

[www.wago.com/890-384](http://www.wago.com/890-384)

### Cover

Cover



**Item no.: 897-2003**

Protective cap; Type2; for sockets and plugs; PVC; red

[www.wago.com/897-2003](http://www.wago.com/897-2003)

### Mounting

Mounting accessories



**Item no.: 890-310**

Mounting carrier; 2- to 5-pole; for flying leads; black

[www.wago.com/890-310](http://www.wago.com/890-310)



**Item no.: 890-311**

Mounting carrier; 2- to 5-pole; for flying leads; white

[www.wago.com/890-311](http://www.wago.com/890-311)

## Downloads

### Documentation

#### Bid Text

890-294 X81 - Datei	2019 Feb 19	xml 3.0 kB	Download
890-294 doc - Datei	2015 Jun 8	doc 24.6 kB	Download

### CAD/CAE-Data

#### CAE data

WSCAD Universe 890-294	URL	Download
------------------------	-----	----------

Subject to changes. Please also observe the further product documentation!



ZUKEN Portal 890-294

[URL](#)

[Download](#)

## CAD data

2D/3D Models 890-294

[URL](#)

[Download](#)

## Environmental Product Compliance

### Compliance Search

Environmental Product Compliance 890-294

[URL](#)

[Download](#)

Plug; 4-pole; 1,50 mm<sup>2</sup>; pink

## Installation Notes

### Conductor termination

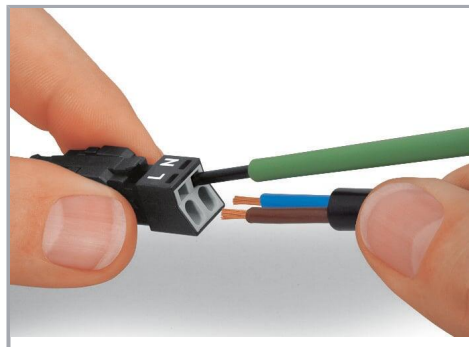
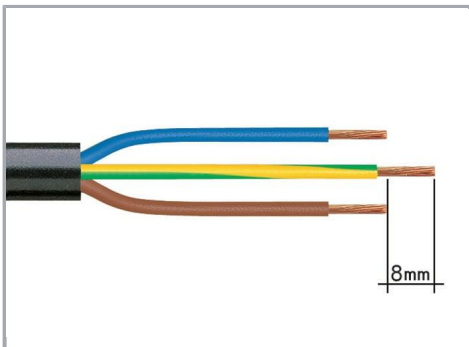

1. Strip length, outer insulation = 30 mm (2-pole), 37 mm (3-pole), 45 mm (4- and 5-pole)
2. Strip length = 9 mm
3. Extended ground conductor = 8 mm

To terminate fine-stranded conductors, open the clamping unit via screwdriver – 2.5 mm blade width – and insert a stripped conductor until it hits the backstop. Terminate solid conductors by simply pushing them in.

Subject to changes. Please also observe the further product documentation!

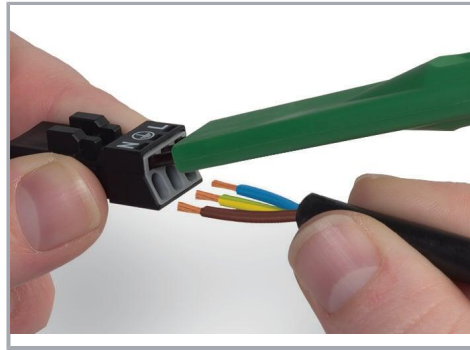
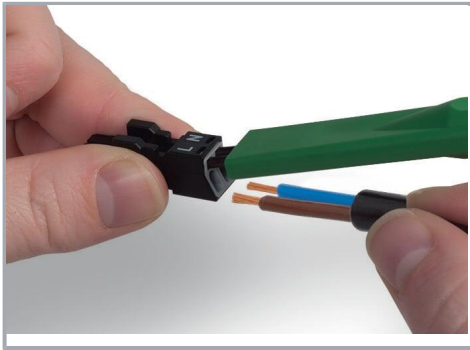

To terminate fine-stranded conductors, open clamping units via operating tool (890-382) and insert stripped conductors until they hit backstop.

To terminate fine-stranded conductors, open clamping units via operating tool (890-383) and insert stripped conductors until they hit backstop.

Terminate solid conductors by simply pushing them in.

Terminate solid conductors by simply pushing them in.

#### Installation

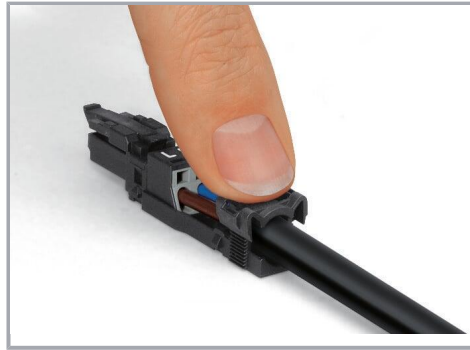
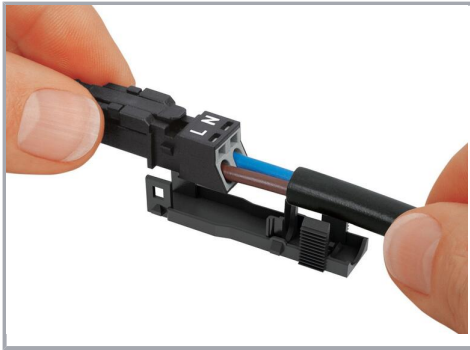

Latch the wired connector into the base of the strain relief housing.

Push down strain relief clamp by hand.

Subject to changes. Please also observe the further product documentation!



Push down strain relief clamp with 2.5 mm screwdriver alternately on both sides.

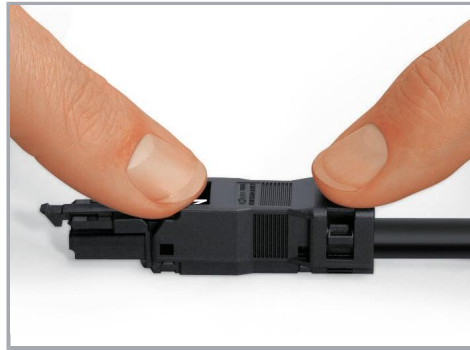

Latch the top of the strain relief housing.



The printed marking of the connector is clearly visible in the openings of the strain relief housing.

#### Mismatching protection

Subject to changes. Please also observe the further product documentation!

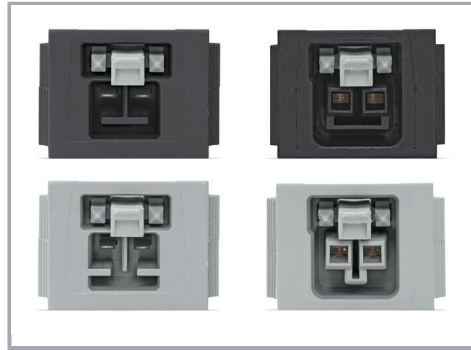
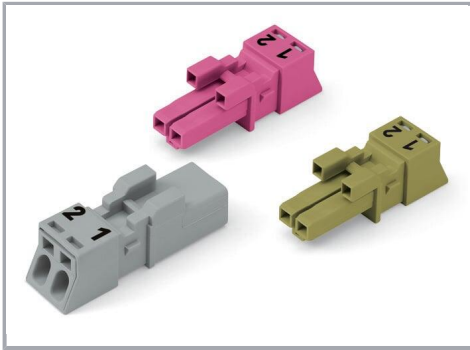

B-coded connectors with different colors can be plugged together.

**Important note:**

Different colors and/or pole markings are used for circuit identification.

Only connectors of the same color and same pole marking must be plugged together.

B-coded connectors (shown in gray) not only differ in color, but also in their design, making them incompatible with other coded connectors.



**Product family**

**WINSTA® MINI**

[Show all products from the family](#)

Subject to changes. Please also observe the further product documentation!