

10 9 8 7 6 5 4 3 2 1

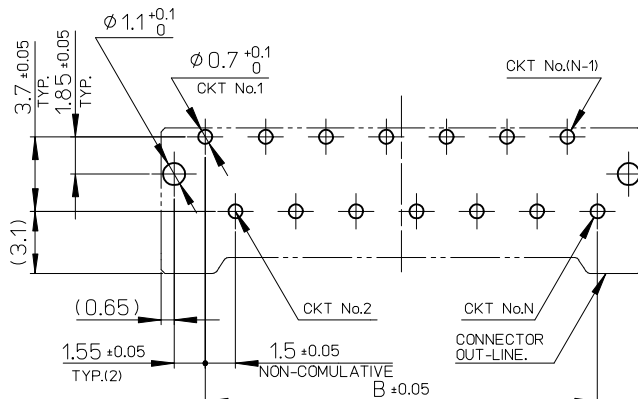

基板取付穴推奨寸法(マウント面)
RECOMMENDED P.C.BOARD
HOLE DIMENSION
(MOUNTING SIDE)
(t=1.6)

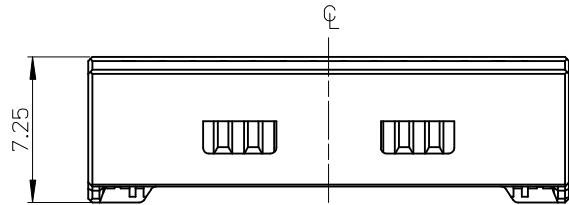
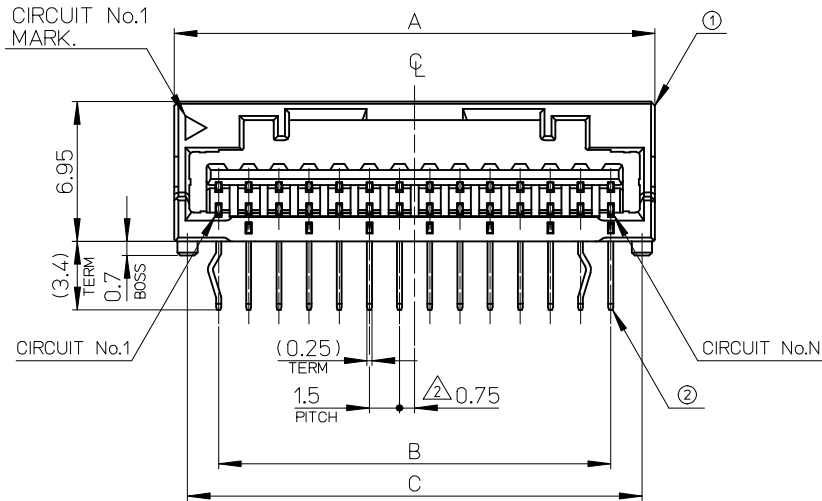
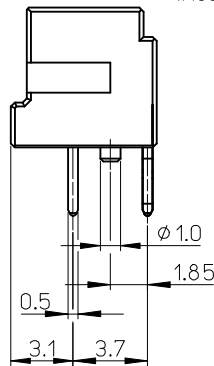

No.	部品 PART	材料 MATERIAL
①	ハウジング HOUSING	ポリアミド(PA) UL94V-0 POLYAMIDE UL94V-0 色:注記 5. 参照 COLOR:SEE NOTES 5.
②	ターミナル TERMINAL	銅合金 COPPER ALLOY テール部: 鍍めつき TAIL AREA: TIN PLATING 下地: ニッケルめっき(1.0μm以上) UNDER PLATING: NICKEL (1.0 MICROMETER MINIMUM)

CIRCUIT No.1
MARK.

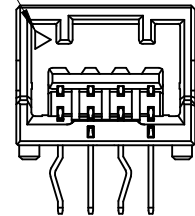

2~11極 CIRCUIT NO.1
CIRCUIT No.1 OF 2-11 CIRCUIT

26.8	24.1	21	25.4	503175-150*	15
25.3	22.6	19.5	23.9	503175-140*	14
23.8	21.1	18	22.4	503175-130*	13
22.3	19.6	16.5	20.9	503175-120*	12
20.8	18.1	15	19.4	503175-110*	11
19.3	16.6	13.5	17.9	503175-100*	10
17.8	15.1	12	16.4	503175-090*	9
16.3	13.6	10.5	14.9	503175-080*	8
14.8	12.1	9	13.4	503175-070*	7
13.3	10.6	7.5	11.9	503175-060*	6
11.8	9.1	6	10.4	503175-050*	5
10.3	7.6	4.5	8.9	503175-040*	4
8.8	6.1	3	7.4	503175-030*	3
7.3	4.6	1.5	5.9	503175-020*	2
D	C	B	A	TRAY PACKAGE △ ORDER NO.	CIRCUIT

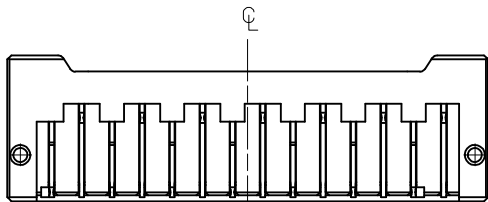

REVISED EC NO: J2009-2905 DRWN: TODA 2009/06/25 CHKD: S. MARIYAMA 2009/06/25 APPR: S. CHIKAWA 2009/06/26	GENERAL TOLERANCES (UNLESS SPECIFIED)		DIMENSION STYLE MM ONLY		SCALE 4:1	DESIGN UNITS METRIC	THIRD ANGLE PROJECTION
	10 UNDER	±0.2	DRAWN BY NNISHI	DATE 2008/06/06	TITLE 1.5 W/B SINGLE DIP R/A REC.ASSY 2-15CKT		
	10 OVER 30 UNDER	±0.25	CHECKED BY KASAKAWA	DATE 2008/06/06	MOLEX INCORPORATED		
	30 OVER	±0.3	APPROVED BY SICHIKAWA	DATE 2008/06/06	DOCUMENT NO. SD-503175-001		
	ANGULAR ±3°	DRAFT WHERE APPLICABLE MUST REMAIN WITHIN DIMENSIONS	MATERIAL NO. SEE CHART		SHEET NO. 1 OF 2		
			SIZE A3		THIS DRAWING CONTAINS INFORMATION THAT IS PROPRIETARY TO MOLEX INCORPORATED AND SHOULD NOT BE USED WITHOUT WRITTEN PERMISSION		

△ COLOR VARIATION&ORDER No.

VIOLET	ORANGE	BROWN	GREEN	PINK	BLUE	YELLOW	RED	BLACK	BEIGE	
503175-1509	503175-1508	503175-1507	503175-1506	503175-1505	503175-1504	503175-1503	503175-1502	503175-1501	503175-1500	15
503175-1409	503175-1408	503175-1407	503175-1406	503175-1405	503175-1404	503175-1403	503175-1402	503175-1401	503175-1400	14
503175-1309	503175-1308	503175-1307	503175-1306	503175-1305	503175-1304	503175-1303	503175-1302	503175-1301	503175-1300	13
503175-1209	503175-1208	503175-1207	503175-1206	503175-1205	503175-1204	503175-1203	503175-1202	503175-1201	503175-1200	12
503175-1109	503175-1108	503175-1107	503175-1106	503175-1105	503175-1104	503175-1103	503175-1102	503175-1101	503175-1100	11
503175-1009	503175-1008	503175-1007	503175-1006	503175-1005	503175-1004	503175-1003	503175-1002	503175-1001	503175-1000	10
503175-0909	503175-0908	503175-0907	503175-0906	503175-0905	503175-0904	503175-0903	503175-0902	503175-0901	503175-0900	9
503175-0809	503175-0808	503175-0807	503175-0806	503175-0805	503175-0804	503175-0803	503175-0802	503175-0801	503175-0800	8
503175-0709	503175-0708	503175-0707	503175-0706	503175-0705	503175-0704	503175-0703	503175-0702	503175-0701	503175-0700	7
503175-0609	503175-0608	503175-0607	503175-0606	503175-0605	503175-0604	503175-0603	503175-0602	503175-0601	503175-0600	6
503175-0509	503175-0508	503175-0507	503175-0506	503175-0505	503175-0504	503175-0503	503175-0502	503175-0501	503175-0500	5
503175-0409	503175-0408	503175-0407	503175-0406	503175-0405	503175-0404	503175-0403	503175-0402	503175-0401	503175-0400	4
503175-0309	503175-0308	503175-0307	503175-0306	503175-0305	503175-0304	503175-0303	503175-0302	503175-0301	503175-0300	3
503175-0209	503175-0208	503175-0207	503175-0206	503175-0205	503175-0204	503175-0203	503175-0202	503175-0201	503175-0200	2
TRAY PACKAGE ORDER NO.	TRAY PACKAGE ORDER NO.	TRAY PACKAGE ORDER NO.	TRAY PACKAGE ORDER NO.	TRAY PACKAGE ORDER NO.	TRAY PACKAGE ORDER NO.	TRAY PACKAGE ORDER NO.	TRAY PACKAGE ORDER NO.	TRAY PACKAGE ORDER NO.	TRAY PACKAGE ORDER NO.	CIRCUIT

NOTES

- 嵌合相手: 502578 シリーズ
MATE WITH : 502578 SERIES.
- △ 極数=偶数に適用
APPLY FOR CIRCUIT SIZE/2=EVEN.
- 端子テール部に錫めっきを使用している為、外観に摺動痕が付く場合があります。
THE WOUND OF FRICTION MIGHT ADHERE TO EXTERNALS
BECAUSE THE TIN PLATING IS USED FOR THE TAIL.

△ 製品番号
MATERIAL No.

503175-***0*

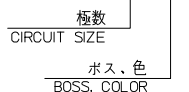

ボス有り WITH BOSS.		COLOR No.	COLOR
CIRCUIT	WITH BOSS No.	0	ベージュ BEIGE
		1	黒 BLACK
		2	赤 RED
		3	黄 YELLOW
		4	青 BLUE
		5	桃 PINK
		6	緑 GREEN
		7	茶 BROWN
		8	橙 ORANGE
9	紫 VIOLET		

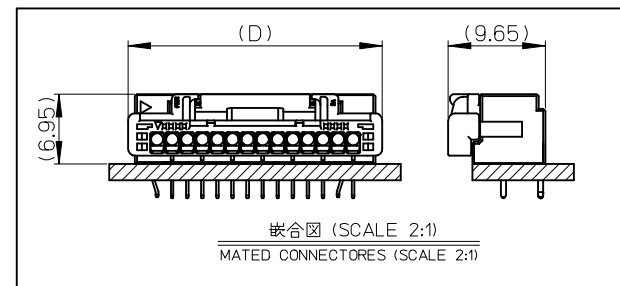
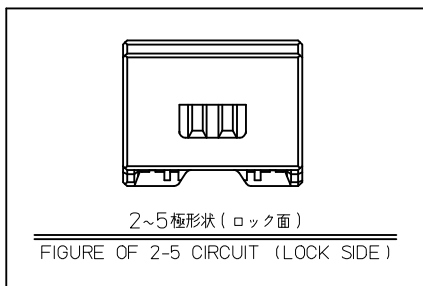

5. 本製品のプラスチック部に黒点・白点等が確認される場合や色合いが異なる場合がありますが、製品性能に影響はありません。
THERE IS NO INFLUENCE IN THE PRODUCT PERFORMANCE THOUGH THE BLACK AND WHITE SPOT ETC. MIGHT BE CONFIRMED TO THE PLASTIC PART OF THIS PRODUCT AND THE SHADE MIGHT BE DIFFERENT.

6. ELV及びRoHS適合品
ELV AND RoHS COMPLIANT

REVISED EC NO: J2009-2905 DRWN: TODA 2009/06/25 CHKD: SMARUYAMA 2009/06/25 APPR: S CHIKAWA 2009/06/26	GENERAL TOLERANCES (UNLESS SPECIFIED)		DIMENSION STYLE MM ONLY		SCALE 4:1	DESIGN UNITS METRIC	THIRD ANGLE PROJECTION
	10 UNDER	±0.2	DRAWN BY NNISHI	DATE 2008/06/06	TITLE 1.5 W/B SINGLE DIP R/A REC.ASSY 2-15CKT		
	10 OVER 30 UNDER	±0.25	CHECKED BY KASAKAWA	DATE 2008/06/06	MOLEX INCORPORATED		
	30 OVER	±0.3	APPROVED BY SICHIKAWA	DATE 2008/06/06	DOCUMENT NO. SD-503175-001	SHEET NO. 2 OF 2	
REV	ANGULAR ±3°	DRAFT WHERE APPLICABLE MUST REMAIN WITHIN DIMENSIONS		ENTER PART			
THIS DRAWING CONTAINS INFORMATION THAT IS PROPRIETARY TO MOLEX INCORPORATED AND SHOULD NOT BE USED WITHOUT WRITTEN PERMISSION				SIZE A3			