

# COAXIAL & TRIAXIAL CONNECTORS FOR BROADCASTING 3T SERIES



## 3T Series (75 $\Omega$ ) for TV camera applications

Particularly intended for outdoor use, the product range of coaxial and triaxial connector of the 3T Series guarantees a protection index of IP66 as per IEC 60529 standard (mated connectors).

The 3T Series models are fully intermatable with the ULC Series size III C75 (coaxial 75  $\Omega$ ) and size III TCX75 (triaxial 75  $\Omega$ ).

## Technical Characteristics

Characteristics	Coax	Triax	Standard
Impedance	75 Ω	75 Ω	–
Operating frequency	1.9 GHz	1.2 GHz	–
VSWR (f= GHz)	1.03 + 0.09f	1.02 + 0.15f	IEC 60169-1-1
Contact resistance	< 2.5 m Ω	< 2.5 m Ω	IEC 60512-2
Contact resis. internal screen	–	< 1.2 m Ω	–
Insulation resistance	> 10 <sup>12</sup> Ω	> 10 <sup>12</sup> Ω	IEC 60512-2
Watertightness	IP66	IP66	IEC 60529

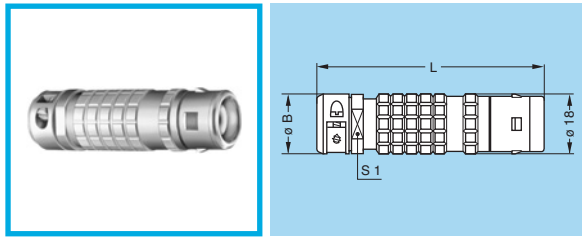
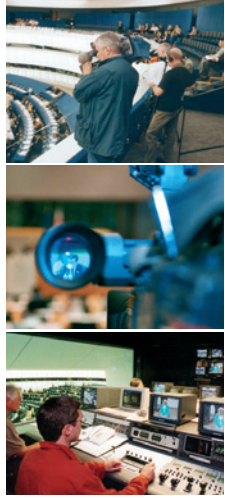

**Note:** Chrome-plated brass outer shell, PTFE insulator, solder male contact, cable clamping, soldered external shield (part number ending with «S»).

## Recommended cables

Reference	Type	Imp. (Ω)	Cable groupe
RG.11A/U	Coax	75±3Ω	5
Belden RG.144/U	Triax	75±3Ω	4
Belden RG.216/U	Triax	75±3Ω	3
Belden 7784A	Triax	75±3Ω	2
Belden 7785A	Triax	75±3Ω	1
Belden 9192-9232	Triax	75±3Ω	4
Belden 9267	Triax	75±3Ω	4
NEK 63990	Triax	75±3Ω	1
DRAKA Triax 8	Triax	75±3Ω	4
DRAKA Triax 11	Triax	75±3Ω	3
DRAKA Triax 14	Triax	75±3Ω	1
Triax Type A2	Triax	75±3Ω	2
Triax Type B2	Triax	75±3Ω	6
Triax Type C2	Triax	75±3Ω	

### FFA Straight plug with cable clamping

Part Number	Type	B	L	S1	Cable groupe
FFA.3T.275.CTAY11	Coax	20	71	18	5
FFA.3T.675.CTAY92S	Triax	20	69	18	1
FFA.3T.675.CTAY11S	Triax	20	69	18	4
FFA.3T.675.CTAY13S	Triax	28	88	26	2
FFA.3T.675.CTAY14S	Triax	28	88	26	3
FFA.3T.675.CTAY17S	Triax	28	88	26	6

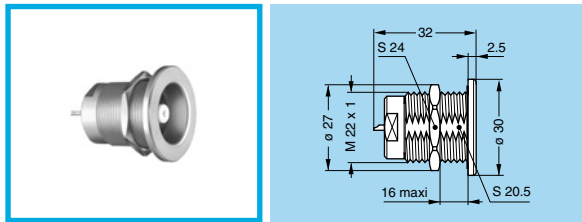

### ERA Fixed socket, nut fixing

Part Number	Type	Weight (g)
ERA.3T.275.CTL	Coax	43.5
ERA.3T.675.CTL	Triax	46.0

**Note:** Chrome-plated brass outer shell, PTFE insulator, solder female contact.

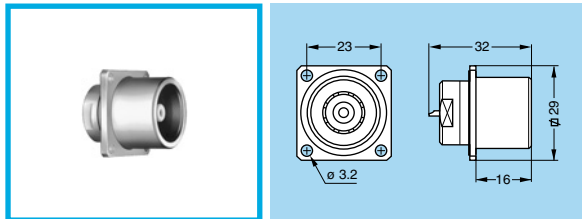

### EBC Fixed socket with square flange, visible shell, screw fixing

Part Number	Type	Weight (g)
EBC.3T.275.CTL	Coax	55.5
EBC.3T.675.CTL	Triax	58.0

**Note:** Chrome-plated brass outer shell, PTFE insulator, solder female contact.

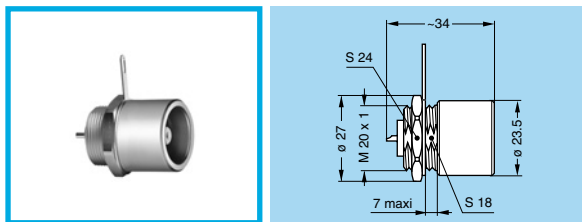

### EHP Fixed socket, nut fixing, visible shell

Part Number	Type	Weight (g)
EHP.3T.675.CTL	Triax	51.0

**Note:** Chrome-plated brass outer shell, PTFE insulator, solder female contact.

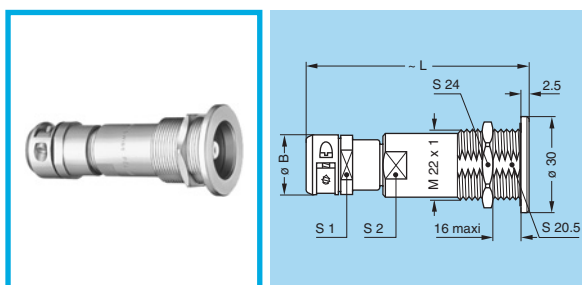

### PSA Fixed socket with cable clamping, nut fixing

Part Number	Type	B	L	S1	S2	Cable groupe
PSA.3T.275.CTLY11	Coax	20	81	18	16	5
PSA.3T.675.CTLY92S	Triax	20	74	18	16	1
PSA.3T.675.CTLY11S	Triax	20	74	18	16	4
PSA.3T.675.CTLY13S	Triax	28	95	26	16	2
PSA.3T.675.CTLY14S	Triax	28	95	26	16	3
PSA.3T.675.CTLY17S	Triax	28	95	26	16	6

**Note:** Chrome-plated brass outer shell, PTFE insulator, solder female contact, cable clamping, soldered external shield (part number ending with «S»).

**Note:** all dimensions are in millimetres.

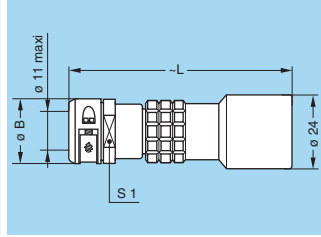

### PCA Free socket with cable clamping

Part Number	Type	B	L	S1	Cable groupe
PCA.3T.675.CTLY92S	Triax	20	76	18	1
PCA.3T.675.CTLY11S	Triax	20	76	18	4
PCA.3T.675.CTLY13S	Triax	28	87	26	2

**Note:** Chrome-plated brass outer shell, PTFE insulator, solder female contact, cable clamping, soldered external shield (part number ending with «S»).

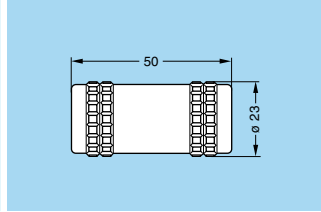

### RMA Free coupler

Part Number	Type	Weight (g)
RMA.3T.275.CTM	Coax	76.0
RMA.3T.675.CTM	Triax	79.0

**Note:** Chrome-plated brass outer shell, PTFE insulator, female-female contact (for mating 2 FFA plugs).

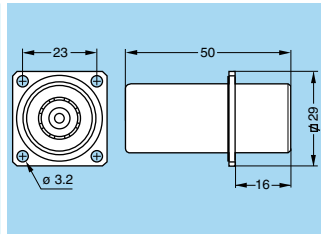
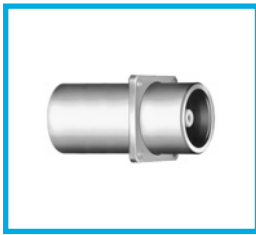

### RBR Fixed coupler with square flange, screw fixing

Part Number	Type	Weight (g)
RBR.3T.275.CTM	Coax	83.0
RBR.3T.675.CTM	Triax	86.0

**Note:** Chrome-plated brass outer shell, PTFE insulator, female-female contact (for mating 2 FFA plugs).

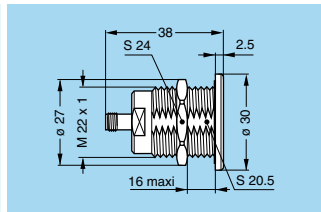
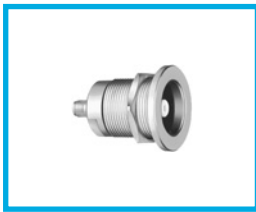

### ASA Adapter, nut fixing, consisting of a LEMO socket and a coax SMA socket

Part Number	Type	Weight (g)
ASA.3T.275.CTM	Coax	51.0

**Note:** Chrome-plated brass outer shell, PTFE insulator, solder female contact.

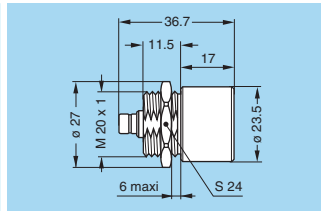

### AZA Adapter, nut fixing, consisting of a LEMO socket and a triax SMZ socket

Part Number	Type	Weight (g)
AZA.3T.675.CTL	Triax	53.0

**Note:** Chrome-plated brass outer shell, PTFE insulator, solder female contact.

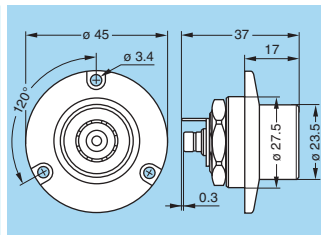
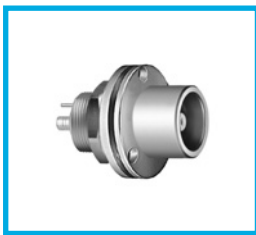

### AZB Adapter, screw fixing, consisting of a LEMO socket and a triax SMZ socket

Part Number	Type	Weight (g)
AZB.3T.675.CTL	Triax	100.0

**Note:** Chrome-plated brass outer shell, PTFE insulator, solder female contact.

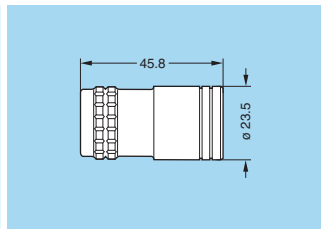
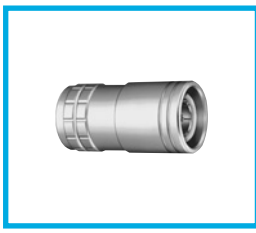

### FWZ Adapter, consisting of a LEMO socket and a REDEL F T75 socket

Part Number	Weight (g)
FWZ.T75.FTS	76.0

**Note:** Chrome-plated brass outer shell, PTFE insulator, solder female contact.

All dimensions are in millimetres.

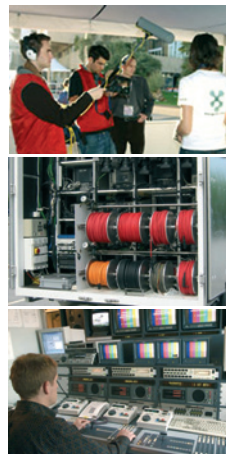

## Accessories

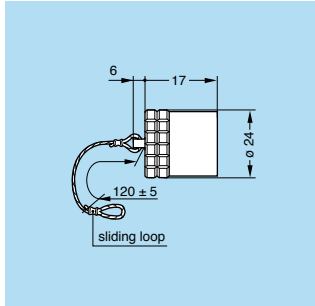

### BFA Plug cap

Part Number	For model	Weight (g)
BFA.3T.100.NAS	FFA	27.0

**Note:**  
 Body material: Nickel-plated brass (Ni 3µm)  
 Lanyard material: Stainless steel  
 Crimp ferrule material: Nickel-plated brass + polyolefin

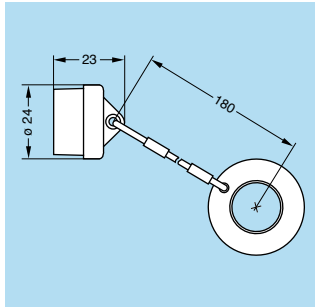

### BFA Plug cap

Part Number	For model	Weight (g)
BFA.3T.100.PCZN	FFA	13.0

**Note:**  
 Body material: Black EPDM  
 Cord material: Black polyester  
 Crimp ferrule material: Nickel-plated brass

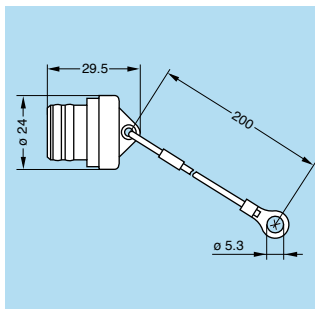

### BRA Blanking cap for fixed sockets

Part Number	For models	Weight (g)
BRA.3T.200.PCZN	ERA, EBC, EHP, PSA, RBR, ASA, AZA, AZB	10.0

**Note:**  
 Body material: Black EPDM  
 Cord material: Black polyester  
 Crimp ferrule material: Stainless steel AISI 304

## Cable stripping lengths

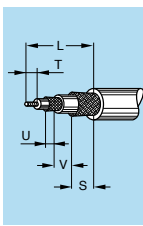

Cable group	Cable stripping lengths (mm)				
	L	S	T	U	V
1	30.0	7.5	11.5	7.0	4
2	41.0	8.0	11.5	7.5	14
3	41.5	8.0	12.0	3.5	18
4	33.5	11.0	11.5	7.0	4
5	26.5	4.5	11.5	6.5	4
6	41.5	8.0	12.0	3.5	18

**Note:** all dimensions are in millimetres.

## Panel cut-outs

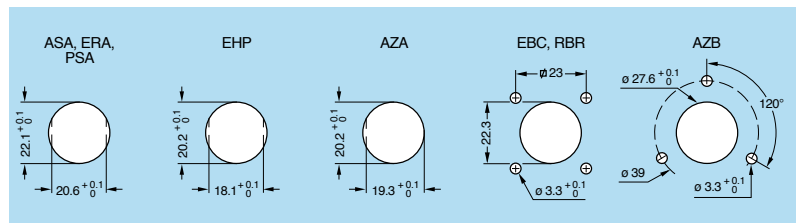

## LEMO HEADQUARTERS

SWITZERLAND  
 LEMO SA  
 Chemin des Champs-Courbes 28 - P.O. Box 194 - CH-1024 Ecublens  
 Tel. (+41 21) 695 16 00 - e-mail: info@lemo.com

[www.lemo.com](http://www.lemo.com)

### Product safety notice & disclaimers:

Please read and follow all instructions specified on <https://www.lemo.com/en/about-lemo/product-safety-notice-and-disclaimers>