



# WLA26P-34162100A00

## W26

COMPACT PHOTOELECTRIC SENSORS

**SICK**  
Sensor Intelligence.



Illustration may differ

### Ordering information

| Type               | Part no. |
|--------------------|----------|
| WLA26P-34162100A00 | 1218823  |

Other models and accessories → [www.sick.com/W26](http://www.sick.com/W26)



### Detailed technical data

#### Features

|   |                                       |
|---|---------------------------------------|
| <b>Functional principle</b>   | Photoelectric retro-reflective sensor |
| <b>Functional principle detail</b>  | Autocollimation                       |
| <b>Sensing range</b>  |                                       |
| Sensing range min.  | 0 m                                   |
| Sensing range max.  | 18 m                                  |
| Maximum distance range from reflector to sensor (operating reserve 1)                           | 0 m ... 18 m                          |
| Recommended distance range from reflector to sensor (operating reserve 3,75)                    | 0 m ... 12 m                          |
| Reference reflector   | Reflector PL80A                       |
| Recommended sensing range for the best performance  | 0 m ... 12 m                          |
| <b>Polarisation filters</b>   | Yes                                   |
| <b>Emitted beam</b>   |                                       |
| Light source  | PinPoint LED                          |
| Type of light   | Visible red light                     |
| Shape of light spot   | Point-shaped                          |
| Light spot size (distance)  | Ø 100 mm (10 m)                       |
| Maximum dispersion of the emitted beam around the standardized transmission axis (squint angle) | < +/- 1.0° (at Ta = +23 °C)           |

|                             |  |
|-----------------------------|--|
| <b>Key LED figures</b>      |  |
| Normative reference         | EN 62471:2008-09   IEC 62471:2006, modified  |
| LED risk group marking      | Free group   |
| Wave length                 | 635 nm   |
| Average service life        | 100,000 h at $T_a = +25 \text{ }^\circ\text{C}$  |
| <b>Adjustment</b>           |  |
| IO-Link                     | For configuring the sensor parameters and Smart Task functions   |
| <b>Indication</b>           |  |
| LED blue                    | BluePilot: Alignment aid   |
| LED green                   | Operating indicator<br>Static on: power on<br>Flashing: IO-Link mode   |
| LED yellow                  | Status of received light beam<br>Static on: object not present<br>Static off: object present<br>Flashing: Below the 1.5 function reserve |
| <b>Special applications</b> |  |
|                             | Detecting objects wrapped in film  |

### Safety-related parameters

|                                     |  |
|-------------------------------------|--|
| <b>MTTF<sub>D</sub></b>             | 627 years                                    |
| <b>DC<sub>avg</sub></b>             | 0 %  |
| <b>T<sub>M</sub> (mission time)</b> | 20 years (EN ISO 13849)<br>Rate of use: 60 % |

### Communication interface

|                             |  |
|-----------------------------|--|
| <b>IO-Link</b>              | ✓, V1.1  |
| Data transmission rate      | COM2 (38,4 kBaud)  |
| Cycle time                  | 2.3 ms   |
| Process data length         | 16 Bit   |
| Process data structure      | Bit 0 = switching signal Q <sub>L1</sub><br>Bit 1 = switching signal Q <sub>L2</sub><br>Bit 2 ... 15 = empty |
| VendorID                    | 26   |
| DeviceID HEX                | 0x800180   |
| DeviceID DEC                | 8388992  |
| Compatible master port type | A  |
| SIO mode support            | Yes  |

### Electrical data

|                                     |  |
|-------------------------------------|--|
| <b>Supply voltage U<sub>B</sub></b> | 10 V DC ... 30 V DC <sup>1)</sup>                                      |
| <b>Ripple</b>                       | ≤ 5 V <sub>pp</sub>  |
| <b>Usage category</b>               | DC-12 (According to EN 60947-5-2)<br>DC-13 (According to EN 60947-5-2) |
| <b>Current consumption</b>          | ≤ 30 mA, without load. At U <sub>B</sub> = 24 V                        |
| <b>Protection class</b>             | III  |

<sup>1)</sup> Limit values.

<sup>2)</sup> Signal transit time with resistive load in switching mode.

<sup>3)</sup> With light/dark ratio 1:1.

|                                       |  |
|---------------------------------------|--|
| <b>Digital output</b>                 |  |
| Number                                | 2 (Complementary)  |
| Type                                  | Push-pull: PNP/NPN   |
| Signal voltage PNP HIGH/LOW           | Approx. $U_B - 2.5 \text{ V} / 0 \text{ V}$  |
| Signal voltage NPN HIGH/LOW           | Approx. $U_B / < 2.5 \text{ V}$  |
| Output current $I_{\text{max}}$       | $\leq 100 \text{ mA}$  |
| Circuit protection outputs            | Reverse polarity protected<br>Overcurrent and short-circuit protected                          |
| Response time                         | $\leq 500 \mu\text{s}$ <sup>2)</sup>   |
| Repeatability (response time)         | 150 $\mu\text{s}$  |
| Switching frequency                   | 1,000 Hz <sup>3)</sup>   |
| <b>Pin/Wire assignment</b>            |  |
| Function of pin 4/black (BK)          | Digital output, light switching, object present → output $Q_{L1}$ LOW; IO-Link communication C |
| Function of pin 4/black (BK) – detail | The pin 4 function of the sensor can be configured, Additional possible settings via IO-Link   |
| Function of pin 2/white (WH)          | Digital output, dark switching, object present → output $\bar{Q}_{L1}$ HIGH                    |
| Function of pin 2/white (WH) – detail | The pin 2 function of the sensor can be configured, Additional possible settings via IO-Link   |

<sup>1)</sup> Limit values.

<sup>2)</sup> Signal transit time with resistive load in switching mode.

<sup>3)</sup> With light/dark ratio 1:1.

### Mechanical data

|   |  |
|---|--|
| <b>Housing</b>  | Rectangular                                  |
| <b>Dimensions (W x H x D)</b>                         | 24.6 mm x 82.5 mm x 53.3 mm                  |
| <b>Connection</b>                                     | Cable with M12 male connector, 4-pin, 317 mm |
| <b>Connection detail</b>                              |  |
| Deep-freeze property                                  | Do not bend below 0 °C                       |
| Conductor size  | 0.14 mm <sup>2</sup>                         |
| Cable diameter  | Ø 4.8 mm                                     |
| Length of cable (L)                                   | 270 mm                                       |
| Bending radius  | For flexible use > 12 x cable diameter       |
| Bending cycles  | 1,000,000                                    |
| <b>Material</b>                                       |  |
| Housing   | Plastic, VISTAL®                             |
| Front screen  | Plastic, PMMA                                |
| Cable   | PVC  |
| Male connector  | Plastic, VISTAL®                             |
| <b>Weight</b>   | Approx. 100 g                                |
| <b>Maximum tightening torque of the fixing screws</b> | 1.3 Nm                                       |

### Ambient data

|                         |   |
|-------------------------|---|
| <b>Enclosure rating</b> | IP66 (EN 60529)<br>IP67 (EN 60529)<br>IP69 (EN 60529) <sup>1)</sup> |
|-------------------------|---|

<sup>1)</sup> Replaces IP69K with ISO 20653: 2013-03.

|  |  |
|--|--|
| <b>Ambient operating temperature</b>       | -40 °C ... +60 °C  |
| <b>Ambient temperature, storage</b>        | -40 °C ... +75 °C  |
| <b>Shock resistance</b>                    | 50 g, 11 ms (25 positive and 25 negative shocks per axis, for X, Y, Z axes, 150 shocks in total (EN60068-2-27))<br>50 g, 6 ms (5,000 positive and 5,000 negative shocks per axis, for X, Y, Z axes, 30,000 shocks in total (EN60068-2-27)) |
| <b>Vibration resistance</b>                | 10 Hz ... 2,000 Hz (Amplitude 0.5 mm / 10 g, 20 sweeps per axis, for X, Y, Z axes, 1 octave/min, (EN60068-2-6))  |
| <b>Air humidity</b>                        | 35 % ... 95 %, Relative humidity (no condensation)   |
| <b>Electromagnetic compatibility (EMC)</b> | EN 60947-5-2   |
| <b>Resistance to cleaning agent</b>        | ECOLAB   |
| <b>UL File No.</b>                         | NRKH.E181493 & NRKH7.E181493   |

<sup>1)</sup> Replaces IP69K with ISO 20653: 2013-03.

### Smart Task

|                                  |  |
|----------------------------------|--|
| <b>Smart Task name</b>           | Base logics  |
| <b>Logic function</b>            | Direct<br>AND<br>OR<br>Window<br>Hysteresis                                    |
| <b>Timer function</b>            | Deactivated<br>On delay<br>Off delay<br>ON and OFF delay<br>Impulse (one shot) |
| <b>Inverter</b>                  | Yes  |
| <b>Switching frequency</b>       | SIO Logic: 800 Hz <sup>1)</sup><br>IOL: 650 Hz <sup>2)</sup>                   |
| <b>Response time</b>             | SIO Logic: 600 µs <sup>1)</sup><br>IOL: 750 µs <sup>2)</sup>                   |
| <b>Repeatability</b>             | SIO Logic: 300 µs <sup>1)</sup><br>IOL: 400 µs <sup>2)</sup>                   |
| <b>Switching signal</b>          |  |
| Switching signal Q <sub>L1</sub> | Switching output   |
| Switching signal $\bar{Q}_{L1}$  | Switching output   |

<sup>1)</sup> Use of Smart Task functions without IO-Link communication (SIO mode).

<sup>2)</sup> Use of Smart Task functions with IO-Link communication function.

### Diagnosis

|                         |                            |
|-------------------------|----------------------------|
| <b>Device status</b>    | Yes                        |
| <b>Quality of teach</b> | Yes                        |
| <b>Quality of run</b>   | Yes, Contamination display |

### Classifications

|                     |          |
|---------------------|----------|
| <b>eCl@ss 5.0</b>   | 27270902 |
| <b>eCl@ss 5.1.4</b> | 27270902 |
| <b>eCl@ss 6.0</b>   | 27270902 |
| <b>eCl@ss 6.2</b>   | 27270902 |

|                       |          |
|-----------------------|----------|
| <b>eCl@ss 7.0</b>     | 27270902 |
| <b>eCl@ss 8.0</b>     | 27270902 |
| <b>eCl@ss 8.1</b>     | 27270902 |
| <b>eCl@ss 9.0</b>     | 27270902 |
| <b>eCl@ss 10.0</b>    | 27270902 |
| <b>eCl@ss 11.0</b>    | 27270902 |
| <b>eCl@ss 12.0</b>    | 27270902 |
| <b>ETIM 5.0</b>       | EC002717 |
| <b>ETIM 6.0</b>       | EC002717 |
| <b>ETIM 7.0</b>       | EC002717 |
| <b>ETIM 8.0</b>       | EC002717 |
| <b>UNSPSC 16.0901</b> | 39121528 |

### Connection type

M12 male connector, 4-pin

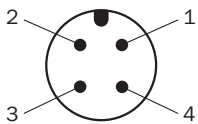

### Connection diagram

Cd-390

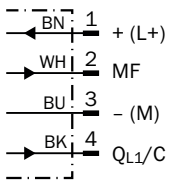

**Characteristic curve**

Reflective tape

Operating reserve

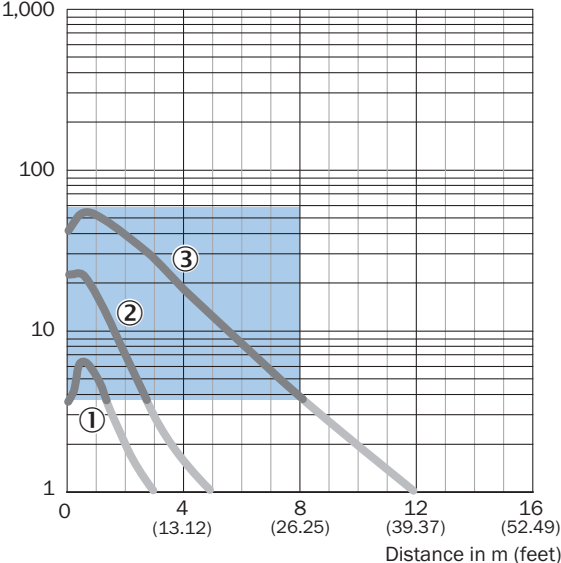

- Recommended sensing range for the best performance
- ① Reflective tape REF-DG (50 x 50 mm)
- ② Reflective tape REF-IRF-56 (50 x 50 mm)
- ③ Reflective tape REF-AC1000 (50 x 50 mm)

Standard reflectors

Operating reserve

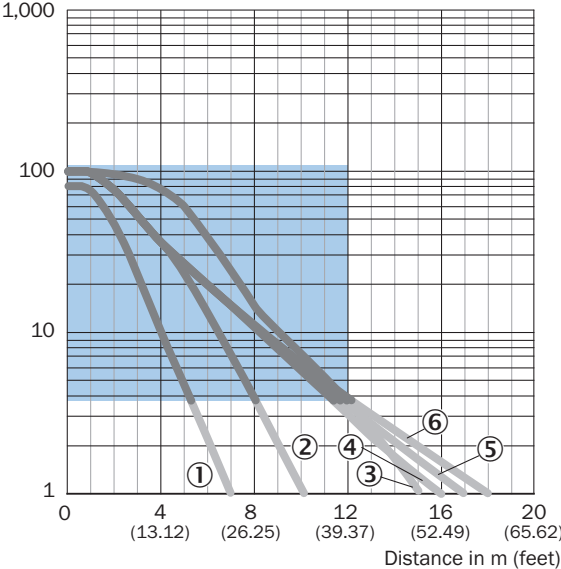

- Recommended sensing range for the best performance
- ① Reflector PL20A
- ② Reflector PL22
- ③ Reflector PL250
- ④ Reflector PL30A
- ⑤ Reflector PL40A
- ⑥ Reflector PL80A, C110A

### Chemical-resistant reflectors

Operating reserve

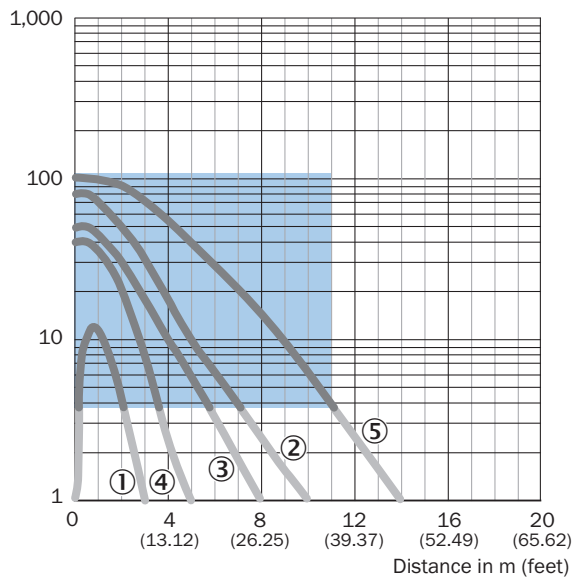

Recommended sensing range for the best performance

- ① PL10F CHEM reflector
- ② Reflector P250H
- ③ Reflector P250 CHEM
- ④ Reflector PL20 CHEM
- ⑤ Reflector PL40A Antifog

### Fine triple reflectors

Operating reserve

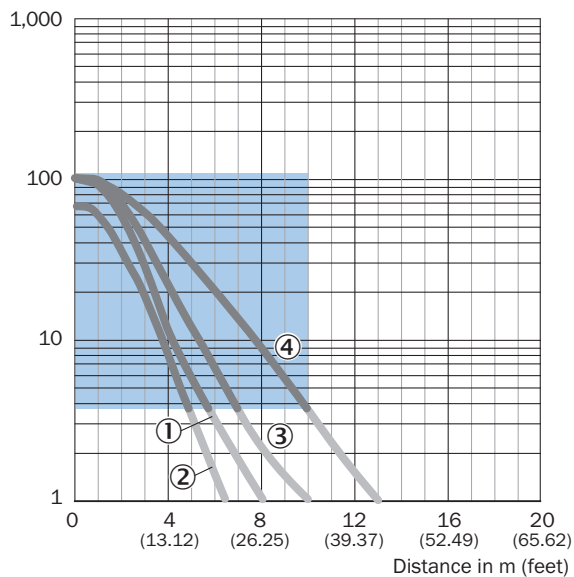

Recommended sensing range for the best performance

- ① PL10FH-1 reflector
- ② PL10F reflector
- ③ Reflector PL20F
- ④ Reflector P250F



Light spot size

WLA26P-xxxxx1xx

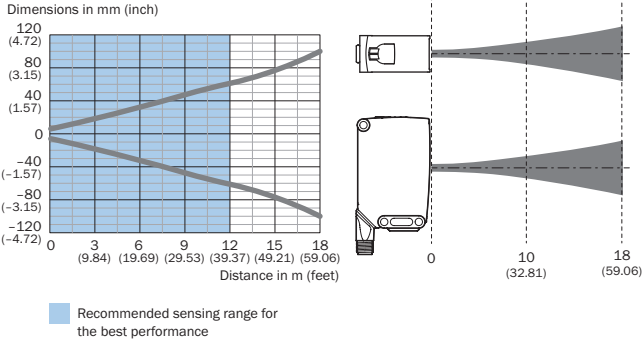

Sensing range diagram

Standard reflectors

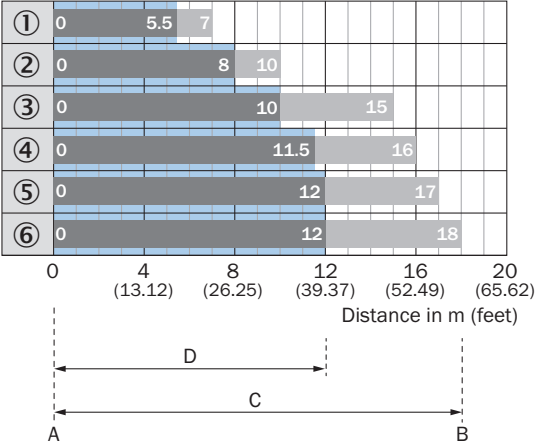

Recommended sensing range for the best performance

|   |   |
|---|---|
| 1 | Reflector PL20A   |
| 2 | Reflector PL22  |
| 3 | Reflector P250  |
| 4 | Reflector PL30A   |
| 5 | Reflector PL40A   |
| 6 | Reflector PL80A, C110A  |
| A | Sensing range min. in m   |
| B | Sensing range max. in m   |
| C | Maximum distance range from reflector to sensor (operating reserve 1)             |
| D | Recommended distance range from re-<br>flector to sensor (operating reserve 3,75) |

### Reflective tape

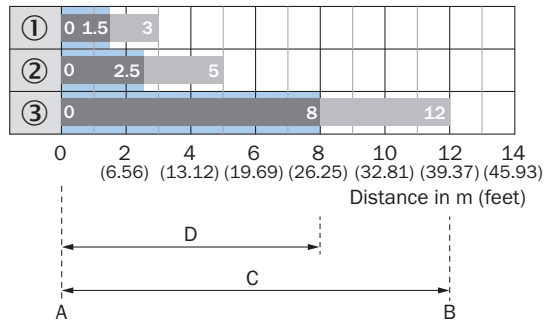

Recommended sensing range for the best performance

|   |  |
|---|--|
| 1 | Reflective tape REF-DG (50 x 50 mm)  |
| 2 | Reflective tape REF-IRF-56 (50 x 50 mm)                                      |
| 3 | Reflective tape REF-AC1000 (50 x 50 mm)                                      |
| A | Sensing range min. in m  |
| B | Sensing range max. in m  |
| C | Maximum distance range from reflector to sensor (operating reserve 1)        |
| D | Recommended distance range from reflector to sensor (operating reserve 3,75) |

### Fine triple reflectors

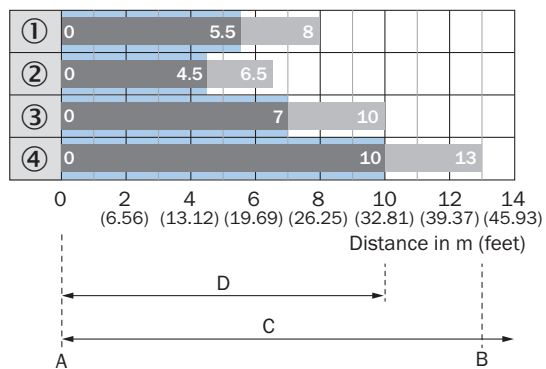

Recommended sensing range for the best performance

|   |  |
|---|--|
| 1 | PL10FH-1 reflector   |
| 2 | PL10F reflector  |
| 3 | Reflector PL20F  |
| 4 | Reflector P250F  |
| A | Sensing range min. in m  |
| B | Sensing range max. in m  |
| C | Maximum distance range from reflector to sensor (operating reserve 1)        |
| D | Recommended distance range from reflector to sensor (operating reserve 3,75) |

Chemical-resistant reflectors

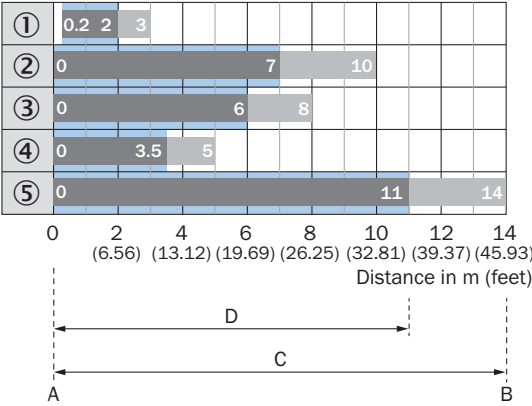

Recommended sensing range for the best performance

|   |  |
|---|--|
| 1 | PL10F CHEM reflector   |
| 2 | Reflector P250H  |
| 3 | Reflector P250 CHEM  |
| 4 | Reflector PL20 CHEM  |
| 5 | Reflector PL40A Antifog  |
| A | Sensing range min. in m  |
| B | Sensing range max. in m  |
| C | Maximum distance range from reflector to sensor (operating reserve 1)        |
| D | Recommended distance range from reflector to sensor (operating reserve 3,75) |

Functions

Operation note

BluePilot: Blue indicator LEDs with double benefits

Easy and quick sensor alignment with the help of the LED indicator

All blue LEDs illuminate

- optimum alignment
- highest possible operating reserve

WLA photoelectric retro-reflection sensor alignment

**Service note**

A reduction in sensor availability is displayed by a decrease of the blue LEDs.

Possible causes:

- a) insufficient alignment
- b) contamination of the optical surfaces
- c) particles in the light beam

### Operation note

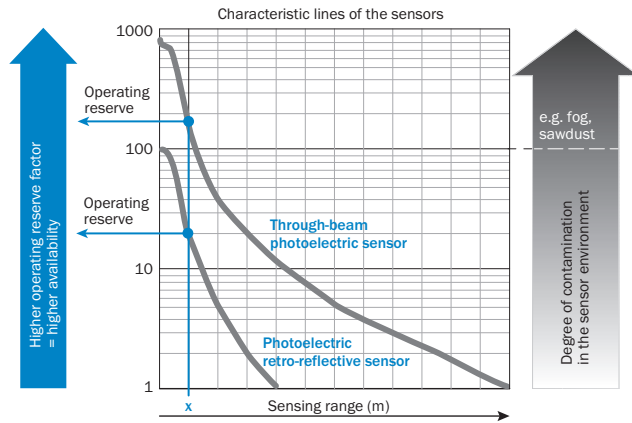

At a sensing range of „x“ the photoelectric retro-reflective and through-beam photoelectric sensors have different operating reserves (see blue arrow). The higher the operating reserve factor, the better the sensor can compensate the contamination in the air or in the light beam and on the optical surfaces (front screen, reflector), i.e. the sensor has the maximum availability, otherwise the sensor switches due to pollution although there is no object in the path of the light beam.

### Adjustments

Display and adjustment elements

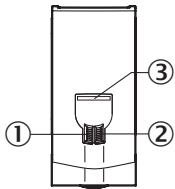

- ① LED indicator green
- ② LED indicator yellow
- ③ LED blue

**Dimensional drawing** (Dimensions in mm (inch))



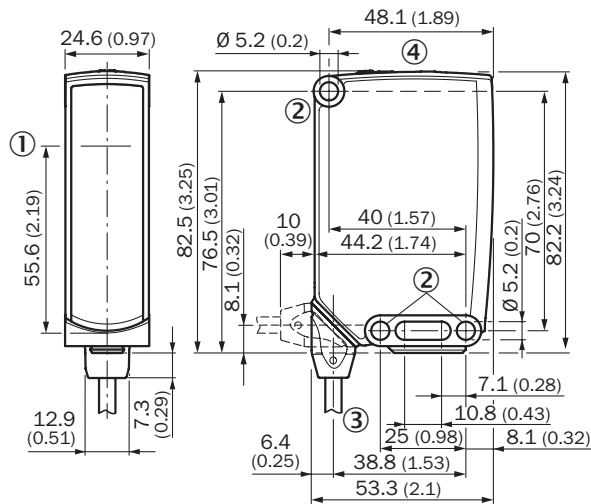

WLA26, cable



- ① Center of optical axis
- ② Mounting hole,  $\varnothing$  5.2 mm
- ③ Connection
- ④ Display and adjustment elements

**Recommended accessories**

Other models and accessories → [www.sick.com/W26](http://www.sick.com/W26)

|   | Brief description  | Type               | Part no. |
|---|--|--------------------|----------|
| <b>Universal bar clamp systems</b>  |  |                    |          |
|  | Plate N12 for universal clamp. For mounting PL30A, P250 reflectors, W27 and WTR2 sensors., Zinc plated steel (sheet), Zinc die cast (clamping bracket), Universal clamp (2022726), mounting hardware | BEF-KHS-N12        | 2071950  |
| <b>Mounting brackets and plates</b>   |  |                    |          |
|  | Universal mounting bracket for reflectors, steel, zinc coated  | BEF-WN-REFX        | 2064574  |
| <b>Plug connectors and cables</b>   |  |                    |          |
|  | Head A: female connector, M12, 4-pin, straight, A-coded<br>Head B: Flying leads<br>Cable: Sensor/actuator cable, PVC, unshielded, 5 m  | YF2A14-050VB3XLEAX | 2096235  |
|  | Head A: male connector, M12, 4-pin, straight<br>Cable: unshielded  | STE-1204-G         | 6009932  |
| <b>Reflectors</b>   |  |                    |          |
|  | Rectangular, screw connection, 84 mm x 84 mm, PMMA/ABS, Screw-on, 2 hole mounting  | PL80A              | 1003865  |

### Recommended services

Additional services → [www.sick.com/W26](http://www.sick.com/W26)

|                        | Type                   | Part no.   |
|------------------------|------------------------|------------|
| Function Block Factory | Function Block Factory | On request |

## SICK AT A GLANCE

SICK is one of the leading manufacturers of intelligent sensors and sensor solutions for industrial applications. A unique range of products and services creates the perfect basis for controlling processes securely and efficiently, protecting individuals from accidents and preventing damage to the environment.

We have extensive experience in a wide range of industries and understand their processes and requirements. With intelligent sensors, we can deliver exactly what our customers need. In application centers in Europe, Asia and North America, system solutions are tested and optimized in accordance with customer specifications. All this makes us a reliable supplier and development partner.

Comprehensive services complete our offering: SICK LifeTime Services provide support throughout the machine life cycle and ensure safety and productivity.

For us, that is “Sensor Intelligence.”

## WORLDWIDE PRESENCE:

Contacts and other locations –[www.sick.com](http://www.sick.com)