

IDMD-24-D-12.00-G

(2.54 mm) .100"

SLIM BODY FLAT RIBBON IDC CABLES

SPECIFICATIONS

For complete specifications see www.samtec.com?IDSS, www.samtec.com?IDSD, www.samtec.com?IDMS or www.samtec.com?IDMD

Insulator Material: Black Glass Filled Polyester
Plating: Au over 50 μ" (1.27 μm) Ni or Sn over 100 μ" (2.54 μm) Cu or 50 μ" (1.27 μm) Ni

Wire: 28 AWG 7/36 stranded Tinned Copper
Temperature Range: -20 °C to +105 °C (Rainbow Cable) -40 °C to +105 °C (Gray Cable)

Contact (IDSS/IDSD): BeCu
Terminal (IDMS/IDMD): Phosphor Bronze
Current Rating (IDSD/TST): 3.4 A per pin (2 pins powered)
Current Rating (IDMD): 3 A per pin (2 pins powered)

Lead Size Range: (0.56 mm) .022" SQ to (0.71 mm) .028" SQ
Lead Insertion Depth: (5.59 mm) .220" to (6.22 mm) .245"
RoHS Compliant: Yes

RECOGNITIONS

For complete scope of recognitions see www.samtec.com/quality



Mates with:

TSW, MTSW, TSM, EJH, PHT, HMTSW, HTSW, HW, DW, EW, ZW, MTLW

IDSD Mates with:

TST, HTST, ZST, BST, EJH

IDM
= Standard Tail Male Plug

IDS
= Socket

TYPE STRIP

ROW OPTION

NO. PINS PER ROW

END ASSEMBLY

S
= Single

D
= Double
(Color coded cable N/A for 31 thru 36 pins/row. See -G option.)

-S = Single End

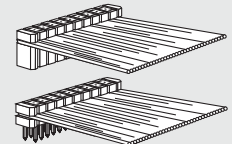

Socket or Male Plug on one end

-D = Double End

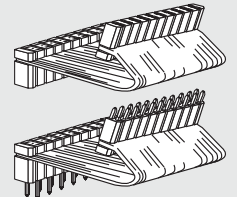

Socket or Male Plug on each end

-T = Transfer End

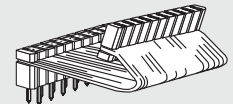

Male Plug on one end with socket on other. Begin part number with IDM.

-02 thru -32

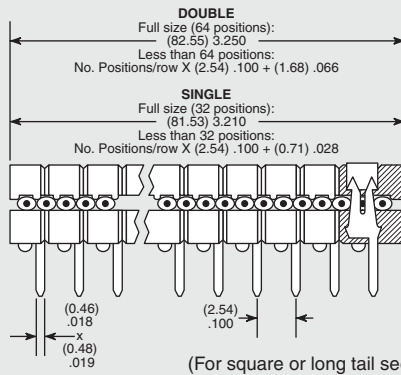

IDMS (Single) **IDMD (Double)**

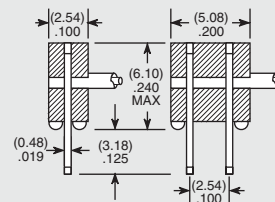

-02 thru -36

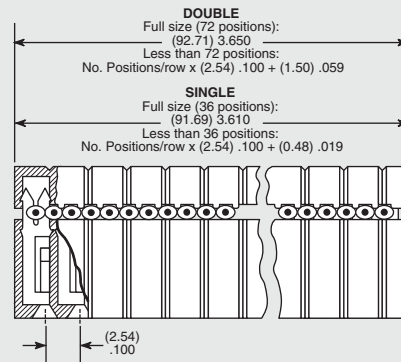

IDSS (Single) **IDSD (Double)**

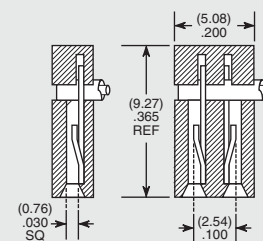

OTHER SOLUTIONS

Molded-To-Position IDC Assemblies

- Low profile
- Skinny side locks
- Dual beam contacts
- Single and double row
- (3.05 mm) .120" and (5.84 mm) .230" length tail available

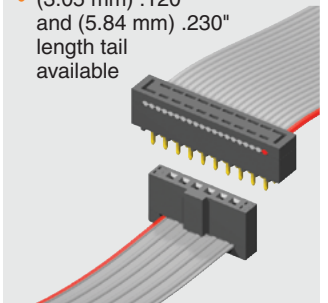

Due to technical progress, all designs, specifications and components are subject to change without notice.

Note: This Series is non-standard, non-returnable.

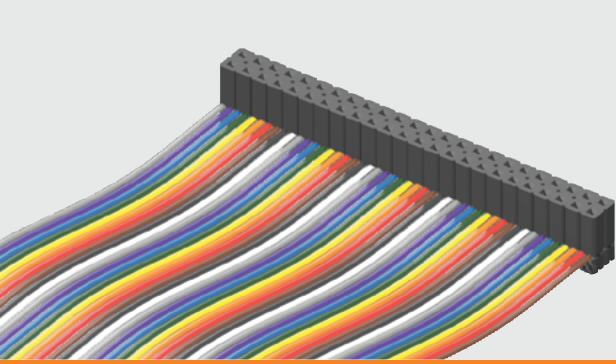

IDSD-24-S-05.00

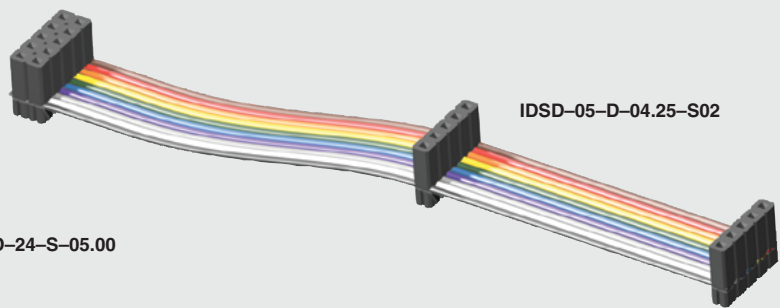

IDSD-05-D-04.25-S02

IDSS, IDSD, IDMS, IDMD SERIES

ASSEMBLED LENGTH

— “XX.XX”
= Assembled Length

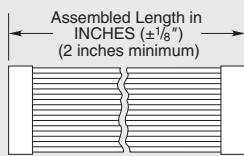

OPTION

POLARIZING KEY

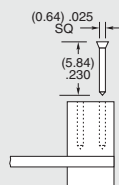

Optional polarizing key for use with IDSS & IDSD Series. Also polarizes SSW, SSQ, ESW & ESQ Series. Black High Temperature Thermoplastic

Order: Part Number PK-01-06
(Available in wheels of six each)

EJECTOR HEADERS & LOCKING CLIPS

RUGGEDIZED
— BY SAMTEC —

IDSS or IDSD STRIP ASSEMBLY

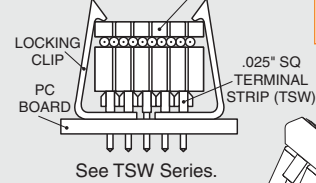

- Ejector headers
- Locking clips

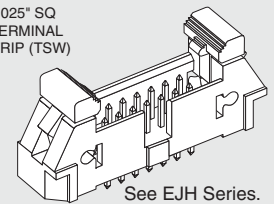

—T = Tin Plating (Both ends)

—C = Tin IDM = 10 μ " (0.25 μ m) Gold IDS (-T End Assembly Required)

—A = 10 μ " (0.25 μ m) Gold IDM = Tin IDS (-T End Assembly Required)

Standard plating is selective gold over BeCu contact for IDS; Selective gold over phosphor bronze for IDM.

1

—ST “X”
= Stripped & Tinned

Specify Suffix from table. All dimensions are $\pm 1/16"$. Not available in 28 positions and higher.

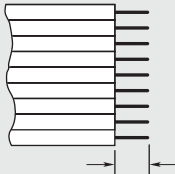

4

—S “XX”
= Daisy Chain Single

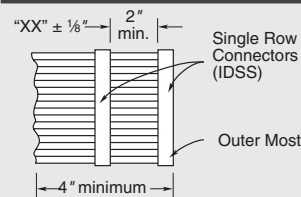

When mating double row connector with two single row connectors, the outer most single will be connected to Conductor #1 and the inside single to Conductor #2.

7

—R
= Reversed

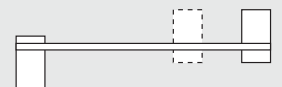

8

—P “XX”
= Polarized

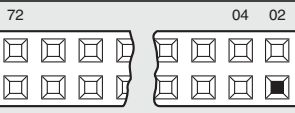

Specify “XX” as position. For Double the same position will be polarized on both ends. (Not available on IDM unless transfer, then only the socket is polarized.)

2

—B “XX”
= Breakout

Specify “XX” as number of conductors to be broken out.

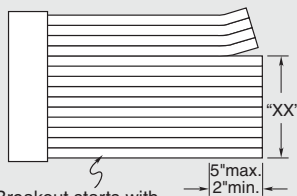

Breakout starts with Number 1 lead indicated by brown wire or red stripe. Shown on top side.

5

—D “XX”
= Daisy Chain, Double

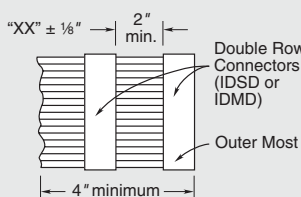

7

—M
= Middle Reversed

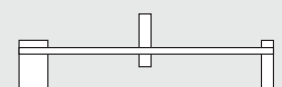

Requires —SXX, —WXX or —DXX

8

—G
= Gray Cable

Specify —G for Gray cable. Gray cable has one red edge. IDSS and IDMS uses .100" centerline cable. IDSD and IDMD uses .050" centerline cable. Cable is 28 AWG 7/36 copper wire. Standard cable is same as above except color coded.

3

—RW
= Reversed Wiring

#1 wire opposite position #1.

6

—W “XX”
= Wiring Reversed Daisy Chain, Single

Same as —S “XX” except outer strip connected to Conductor #2 and inside strip connected to Conductor #1.

7

—O
= Outside Reversed

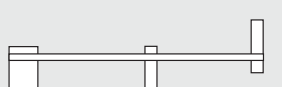

Requires —SXX, —WXX or —DXX

8

Due to technical progress, all designs, specifications and components are subject to change without notice.

WWW.SAMTEC.COM

All parts within this catalog are built to Samtec's specifications.

Customer specific requirements must be approved by Samtec and identified in a Samtec customer-specific drawing to apply.