

**Mounting Option**

04-.156 (3.96) Dia. Mounting Holes

**Contact Detail**

541-Wire Wrap .025 Sq.(0.64 Sq.) - Tail LG=.750(19.05)

.156 [3.96] Contact Spacing x .200 [5.08] Row Spacing

THIS IS A C.A.D. GENERATED DRAWING  
DO NOT MAKE MANUAL REVISIONS TO MASTER.



ISSUE NUMBER	
ORIGINAL	①

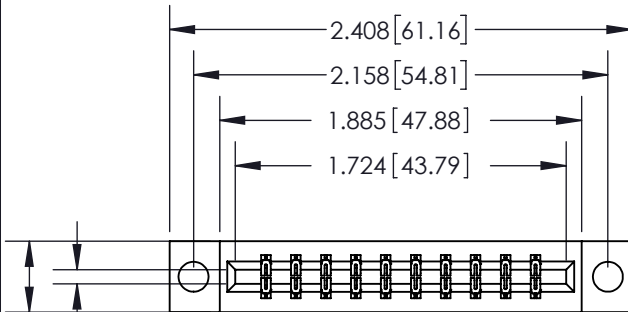

Card Slot Accepts .054 [1.37]  
to .070 (1.78) Thick P.C. Board

0.370 [9.40]

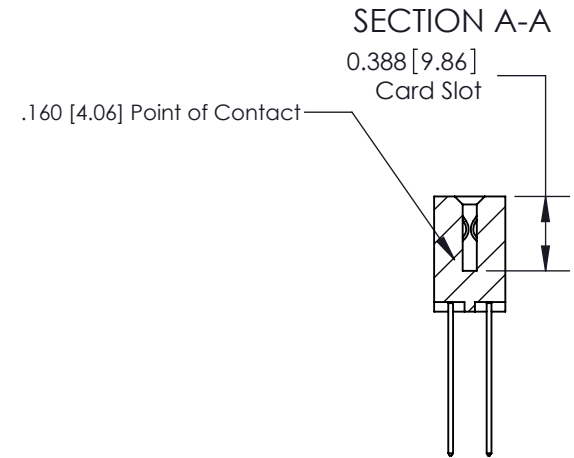
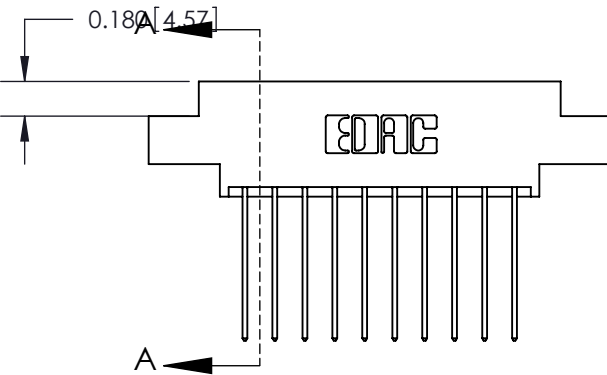

See Accompanying Page for:

- Bend Detail
- Mounting Options

833 Series High Temp Card Edge Connector

Part Number: 833-020-541-804



EDAC INC  
TORONTO, ONTARIO  
CANADA

YOUR CONNECTION TO QUALITY & SERVICE

THESE DRAWINGS AND SPECIFICATIONS  
ARE THE PROPERTY OF EDAC INC. AND  
SHALL NOT BE REPRODUCED, OR COPIED  
OR USED AS THE BASIS FOR THE  
MANUFACTURE OR SALE OF APPARATUS  
WITHOUT WRITTEN PERMISSION.

ACAD REFERENCE NO.	833 ENG MASTER	
DRAWN:	J.LEE	DATE: OCT. 14/09
CHECKED:	DATE:	
SCALE:	NTS	SHEET 1 OF 3
DRAWING NUMBER	833 Assembly	ISSUE 1



555 Contact Code



556 Contact Code



558 Contact Code



559 Contact Code



560 Contact Code

### 833 Series High Temp Card Edge Connector Contact Bend Detail



EDAC INC  
TORONTO, ONTARIO  
CANADA

YOUR CONNECTION TO QUALITY & SERVICE

THESE DRAWINGS AND SPECIFICATIONS  
ARE THE PROPERTY OF EDAC INC. AND  
SHALL NOT BE REPRODUCED, OR COPIED  
OR USED AS THE BASIS FOR THE  
MANUFACTURE OR SALE OF APPARATUS  
WITHOUT WRITTEN PERMISSION.

ACAD REFERENCE NO. 833 ENG MASTER

DRAWN: J.LEE DATE: OCT. 14/09

CHECKED: DATE:

SCALE: NTS SHEET 2 OF 3

DRAWING NUMBER 833 Assembly ISSUE 1

THIS IS A C.A.D. GENERATED DRAWING  
DO NOT MAKE MANUAL REVISIONS TO MASTER.



ISSUE NUMBER  
ORIGINAL ①



### 833 Series High Temp Card Edge Connector Mounting Options



**EDAC INC**  
TORONTO, ONTARIO  
CANADA

YOUR CONNECTION TO QUALITY & SERVICE

THESE DRAWINGS AND SPECIFICATIONS ARE THE PROPERTY OF EDAC INC. AND SHALL NOT BE REPRODUCED, OR COPIED OR USED AS THE BASIS FOR THE MANUFACTURE OR SALE OF APPARATUS WITHOUT WRITTEN PERMISSION.

ACAD REFERENCE NO. 833 ENG MASTER	
DRAWN: J.LEE	DATE: OCT. 14/09
CHECKED:	DATE:
SCALE: NTS	SHEET 3 OF 3
DRAWING NUMBER 833 Assembly	ISSUE 1