



PART NUMBER	CKTS	QUANTITY PER BAG	BAGS PER CARTON	PARTS PER CARTON (SPQ)	MOISTURIZATION METHOD 	PANEL LOCK
215922-0201	2	3000	4	12000	NO MOISTURIZATION	WITHOUT
215922-0401	4	2600	4	10400		
215922-0601	6	2000	4	8000		
215922-0801	8	1700	4	6800		
215922-1001	10	1400	4	5600		
215922-1201	12	1000	4	4000		
215922-1401	14	800	4	3200		
215922-1601	16	800	4	3200		
215922-1801	18	600	4	2400		
215922-2001	20	600	4	2400		
215922-2201	22	600	4	2400		
215922-2401	24	450	4	1800		
215922-0200	2	2000	4	8000	SEE SHEET 2	WITH
215922-0400	4	1800	4	7200		
215922-0600	6	1600	4	6400		
215922-0800	8	1100	4	4400		
215922-1000	10	1000	4	4000		
215922-1200	12	900	4	3600		
215922-1400	14	800	4	3200		
215922-1600	16	700	4	2800		
215922-1800	18	600	4	2400		
215922-2000	20	600	4	2400		
215922-2200	22	400	4	1600		
215922-2400	24	350	4	1400		

TBD: NO PRODUCTION, TO BE ADDED AFTER BEING PRODUCED.

NOTES:

-  MOISTURIZATION METHOD DESCRIPTIONS REFER TO SHEET 2.
- STANDARD PACKAGE QUANTITY (SPQ) SEE ABOVE CHART.
- PACKAGE WAY FOLLOW RIGHT ILLUSTRATION.
- ALL PACKAGE MATERIAL AND PRODUCT COMPLIANT TO RoHS DIRECTIVE 2011/65/EU AND ELV DIRECTIVE 2000/53/EV.

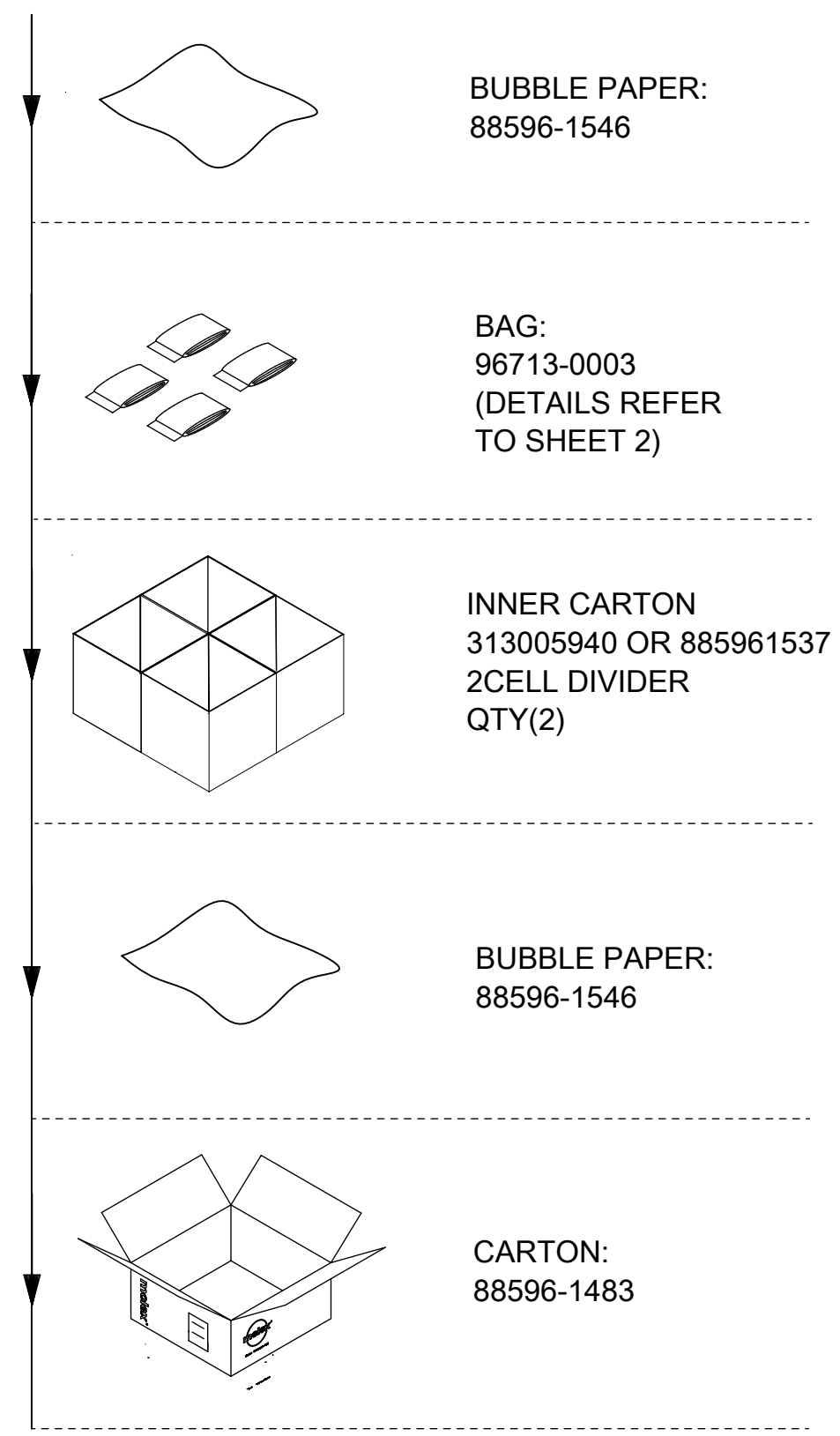

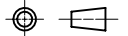
FUNCTIONAL SYMBOLS	THIS DRAWING CONTAINS INFORMATION THAT IS PROPRIETARY TO MOLEX ELECTRONIC TECHNOLOGIES, LLC AND SHOULD NOT BE USED WITHOUT WRITTEN PERMISSION		CURRENT REV DESC:			molex							
	mm	1:1											
DIVISIONAL SYMBOLS	GENERAL TOLERANCES (UNLESS SPECIFIED)		EC NO: 725570 DRWN: GLLI 2022/08/29 CHK'D: XQZHANG 2022/10/31 APPR: XQZHANG 2022/10/31			PACKING SPEC FOR MICRO-FIT PLUS WTW HSG							
	ANGULAR TOL ± °												
	4 PLACES	±				INITIAL REVISION: DRWN: GLLI 2021/10/28 APPR: XQZHANG 2021/11/15			DOCUMENT NUMBER		DOC TYPE	DOC PART	REVISION
	3 PLACES	± 0.1							2159220000-PK		PSD	000	B
	2 PLACES	± 0.3							MATERIAL NUMBER		CUSTOMER		SHEET NUMBER
1 PLACE	± 0.5	DRAFT WHERE APPLICABLE MUST REMAIN WITHIN DIMENSIONS		THIRD ANGLE PROJECTION	DRAWING	SERIES							
0 PLACES	±				A3-SIZE	215922							

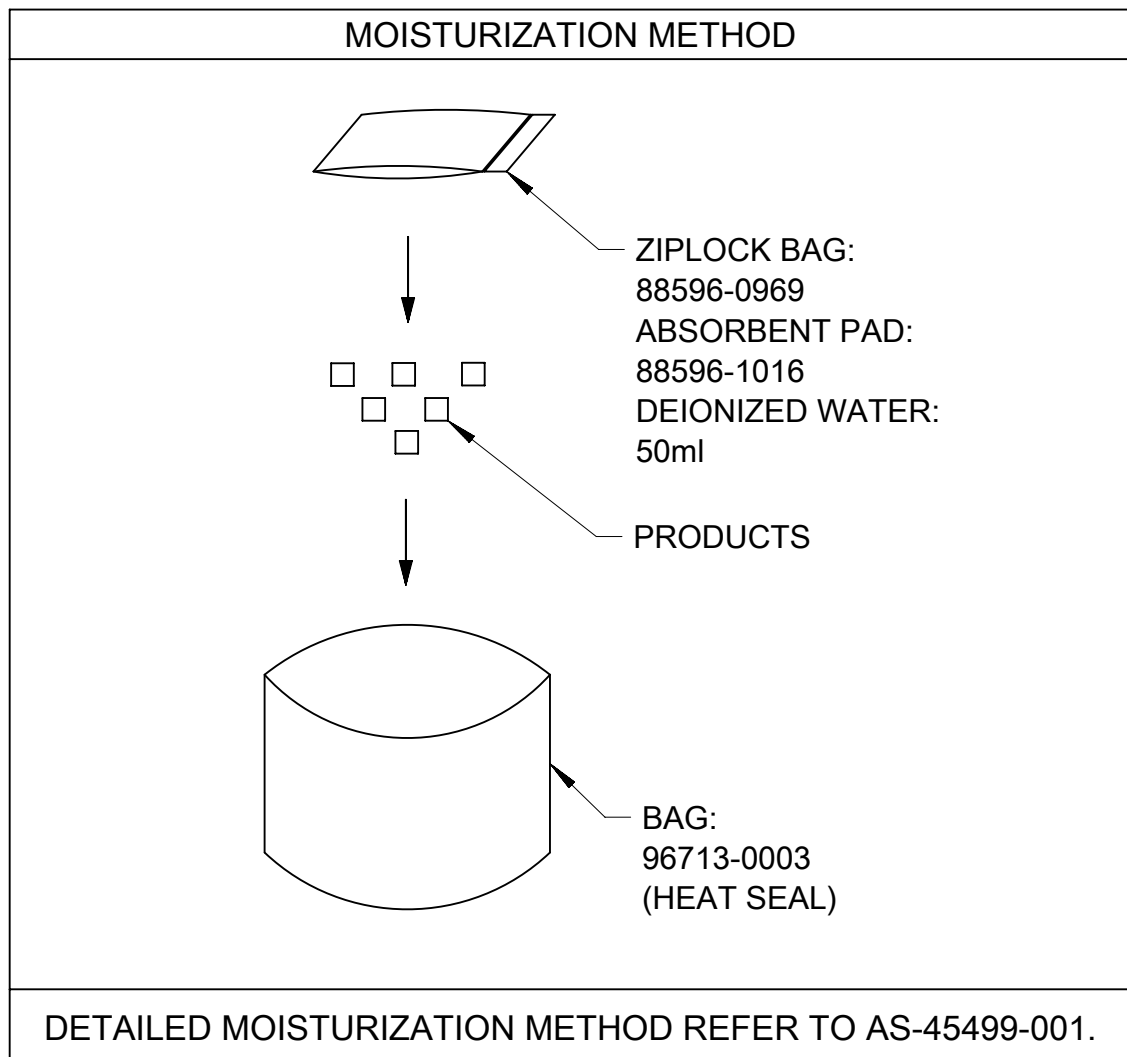

FUNCTIONAL SYMBOLS	THIS DRAWING CONTAINS INFORMATION THAT IS PROPRIETARY TO MOLEX ELECTRONIC TECHNOLOGIES, LLC AND SHOULD NOT BE USED WITHOUT WRITTEN PERMISSION		<h1 style="margin: 0;">molex</h1> PACKING SPEC FOR MICRO-FIT PLUS WTW HSG PRODUCT CUSTOMER DRAWING								
	DIMENSION UNITS	SCALE				CURRENT REV DESC:					
	$\nabla_A = 0$	mm 1:1							EC NO: 725570 DRWN: GLLI 2022/08/29 CHK'D: XQZHANG 2022/10/31 APPR: XQZHANG 2022/10/31		
	GENERAL TOLERANCES (UNLESS SPECIFIED)										
ANGULAR TOL	± °	DOCUMENT NUMBER: 2159220000-PK DOC TYPE: PSD DOC PART: 000 REVISION: B									
4 PLACES	±				MATERIAL NUMBER: 215922 CUSTOMER: A3-SIZE						
3 PLACES	± 0.1	SHEET NUMBER: 2 OF 2									
2 PLACES	± 0.3				THIRD ANGLE PROJECTION						
1 PLACE	± 0.5	DRAWING: A3-SIZE SERIES: 215922									
0 PLACES	±				DRAFT WHERE APPLICABLE MUST REMAIN WITHIN DIMENSIONS						
DIVISIONAL SYMBOLS											

FREE HANGING PLUG PARTS

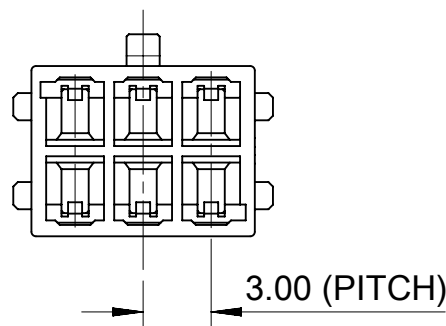
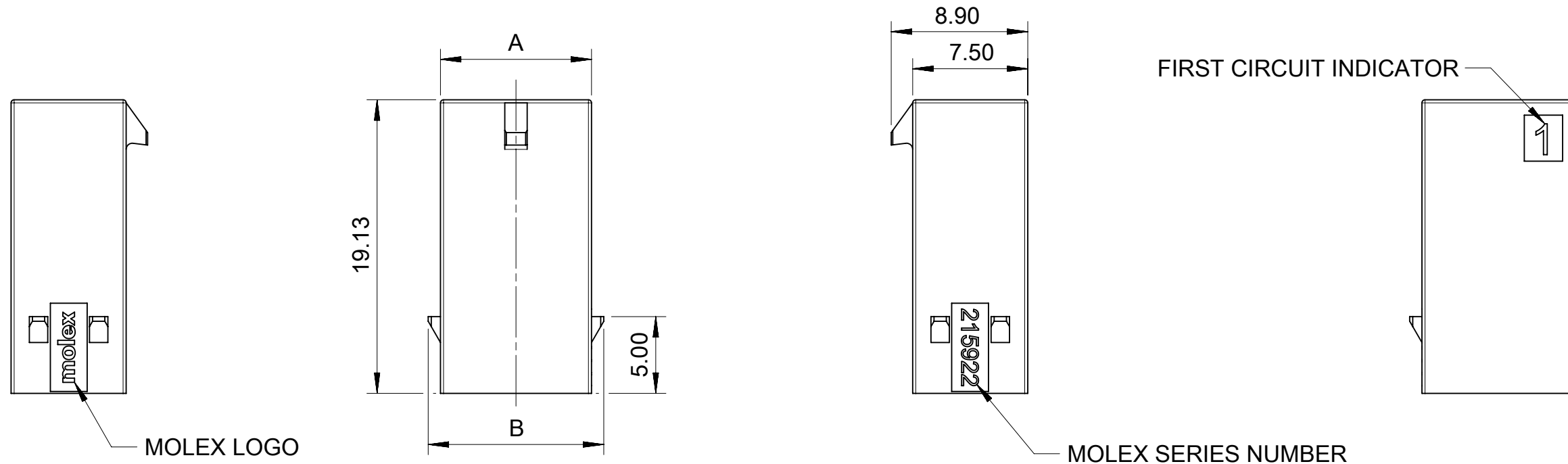

PART No	DIM'A'	DIM'B'	CKT SIZE
215922-0201	3.85	5.45	2
215922-0401	6.85	8.45	4
215922-0601	9.85	11.45	6
215922-0801	12.85	14.45	8
215922-1001	15.85	17.45	10
215922-1201	18.85	20.45	12
215922-1401	21.85	23.45	14
215922-1601	24.85	26.45	16
215922-1801	27.85	29.45	18
215922-2001	30.85	32.45	20
215922-2201	33.85	35.45	22
215922-2401	36.85	38.45	24

- NOTES:
1. MATERIAL: PA66, 94V-0, BLACK.
 2. PRODUCT SPECIFICATION: 2159530000-PS.
 3. PACKAGE SPECIFICATION: 2159220000-PK.
 4. TO USE WITH TERMINAL OF 2015953-****.
 5. TO USE WITH TPA OF 206462-****.
 6. TO MATE WITH RECEPTACLE OF 206461-****.
 7. PARTS CONFORM TO CLASS 'B' REQUIREMENTS OF COSMETIC SPECIFICATION PS-45499-002.

FUNCTIONAL SYMBOLS	THIS DRAWING CONTAINS INFORMATION THAT IS PROPRIETARY TO MOLEX ELECTRONIC TECHNOLOGIES, LLC AND SHOULD NOT BE USED WITHOUT WRITTEN PERMISSION		CURRENT REV DESC:					
	$\nabla_A = 0$ $\nabla_E = 0$ $\nabla_F = 0$	DIMENSION UNITS: mm SCALE: 1:1						
DIVISIONAL SYMBOLS	4 PLACES	±	EC NO: 712744	2022/07/01	PLUG HOUSING OF MICRO-FIT PLUS WTW DR POWER CONNECTOR			
	3 PLACES	±	DRWN: GLLI	2022/07/05				
	2 PLACES	± 0.2	CHK'D: XQZHANG	2022/07/05	PRODUCT CUSTOMER DRAWING			
	1 PLACE	± 0.3	APPR: XQZHANG	2022/07/05				
0 PLACES	±	INITIAL REVISION:		DOCUMENT NUMBER	DOC TYPE	DOC PART	REVISION	
DRAFT WHERE APPLICABLE MUST REMAIN WITHIN DIMENSIONS		THIRD ANGLE PROJECTION	DRAWING	SERIES	MATERIAL NUMBER	CUSTOMER	SHEET NUMBER	
			A3-SIZE	215922	2159220000-SD	PSD	000	A1
					GENERAL MARKET		1 OF 6	

FREE HANGING PLUG PARTS

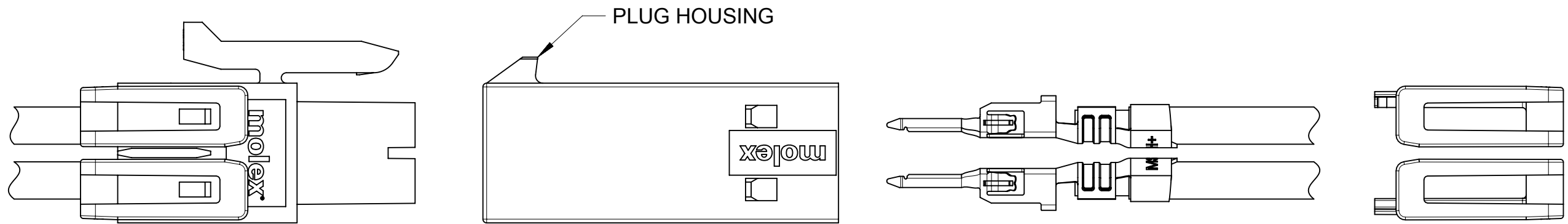
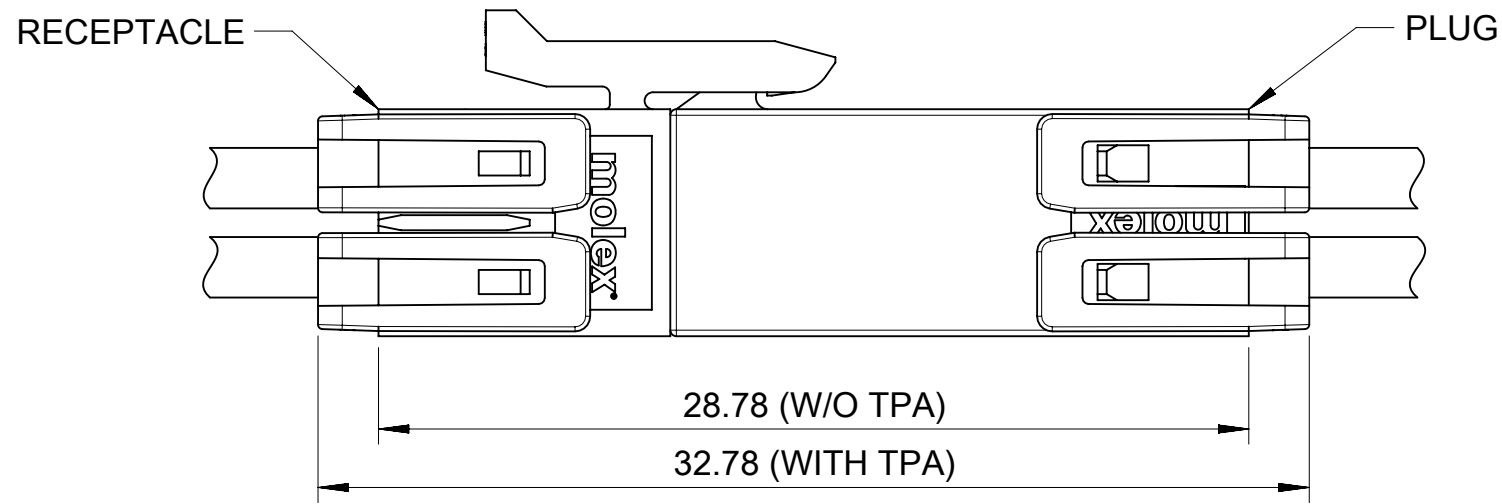

FUNCTIONAL SYMBOLS	THIS DRAWING CONTAINS INFORMATION THAT IS PROPRIETARY TO MOLEX ELECTRONIC TECHNOLOGIES, LLC AND SHOULD NOT BE USED WITHOUT WRITTEN PERMISSION		
	△/A = 0	mm	SCALE 1:1
FUNCTIONAL SYMBOLS	GENERAL TOLERANCES (UNLESS SPECIFIED)		
	△/E = 0	ANGULAR TOL ± °	
DIVISIONAL SYMBOLS	△/V = 0	CURRENT REV DESC:	
	4 PLACES ±	EC NO: 712744	
	3 PLACES ±	DRWN: GLLI 2022/07/01	
	2 PLACES ± 0.2	CHK'D: XQZHANG 2022/07/05	
	1 PLACE ± 0.3	APPR: XQZHANG 2022/07/05	
0 PLACES ±	INITIAL REVISION:		
DRAFT WHERE APPLICABLE MUST REMAIN WITHIN DIMENSIONS		DRWN: GLLI 2021/01/29	2021/11/15
THIRD ANGLE PROJECTION		DRAWING A3-SIZE	SERIES 215922
MATERIAL NUMBER		CUSTOMER	SHEET NUMBER
2159220000-SD		GENERAL MARKET	2 OF 6

FREE HANGING PLUG PARTS

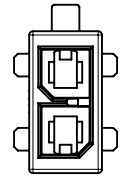

2 CKT

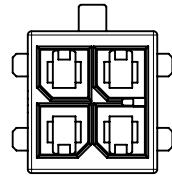

4 CKT

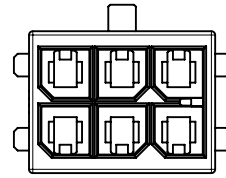

6 CKT

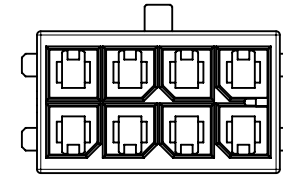

8 CKT

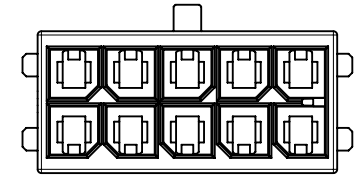

10 CKT

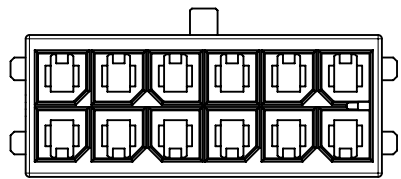

12 CKT

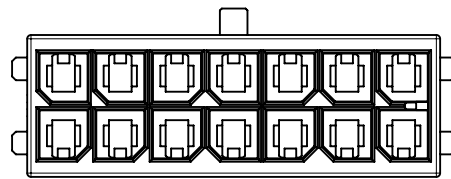

14 CKT

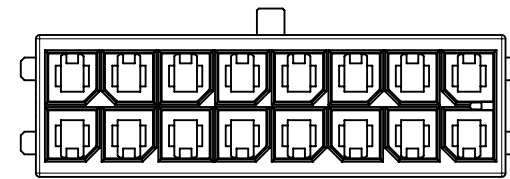

16 CKT

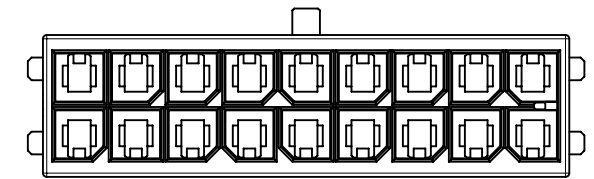

18 CKT

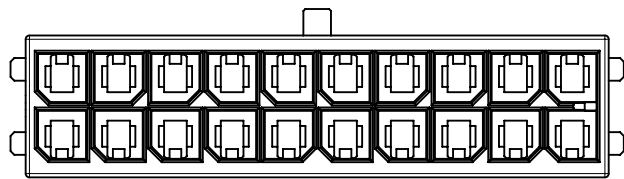

20 CKT

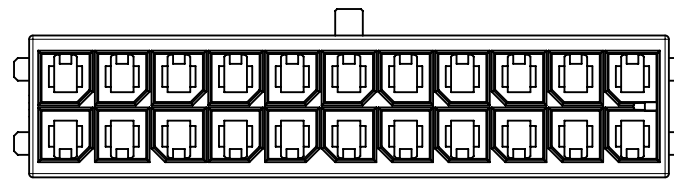

22 CKT

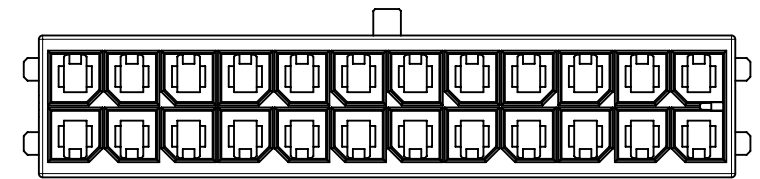

24 CKT

FUNCTIONAL SYMBOLS	THIS DRAWING CONTAINS INFORMATION THAT IS PROPRIETARY TO MOLEX ELECTRONIC TECHNOLOGIES, LLC AND SHOULD NOT BE USED WITHOUT WRITTEN PERMISSION		CURRENT REV DESC:					
	$\nabla_A = 0$ $\nabla_E = 0$ $\nabla_V = 0$	DIMENSION UNITS mm						
DIVISIONAL SYMBOLS	4 PLACES	±	EC NO: 712744		PLUG HOUSING OF MICRO-FIT PLUS WTW DR POWER CONNECTOR			
	3 PLACES	±	DRWN: GLLI		PRODUCT CUSTOMER DRAWING			
	2 PLACES	± 0.2	CHK'D: XQZHANG		DOCUMENT NUMBER			
	1 PLACE	± 0.3	APPR: XQZHANG		2159220000-SD			
	0 PLACES	±	INITIAL REVISION:		DOC TYPE DOC PART REVISION			
DRAFT WHERE APPLICABLE MUST REMAIN WITHIN DIMENSIONS		THIRD ANGLE PROJECTION		DRAWING	SERIES	MATERIAL NUMBER	CUSTOMER	SHEET NUMBER
				A3-SIZE	215922		GENERAL MARKET	3 OF 6

PANEL MOUNT PLUG PARTS

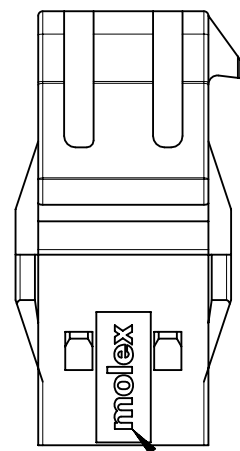

MOLEX LOGO

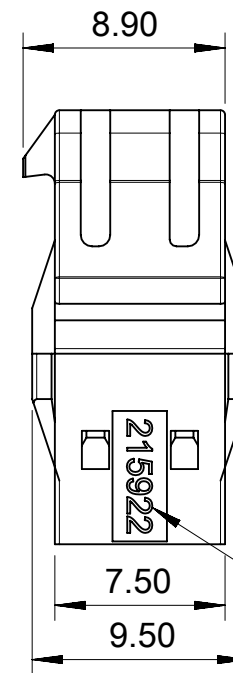
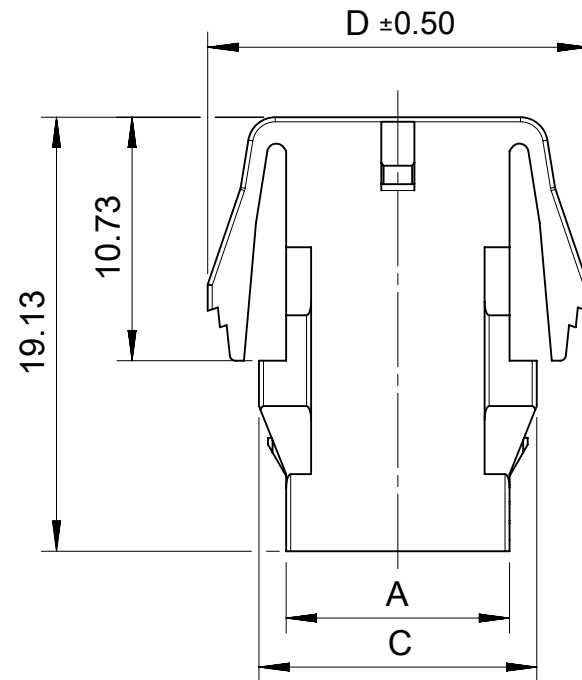

FIRST CIRCUIT INDICATOR

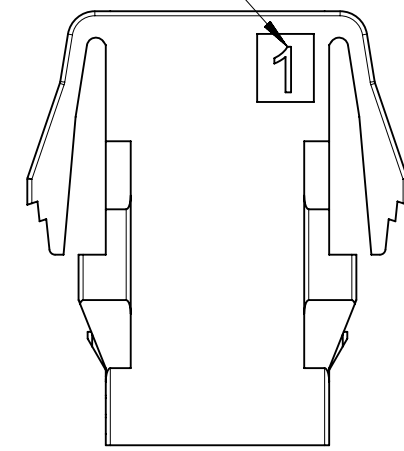

MOLEX SERIES NUMBER

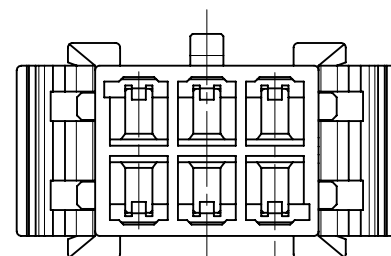

3.00 (PITCH)

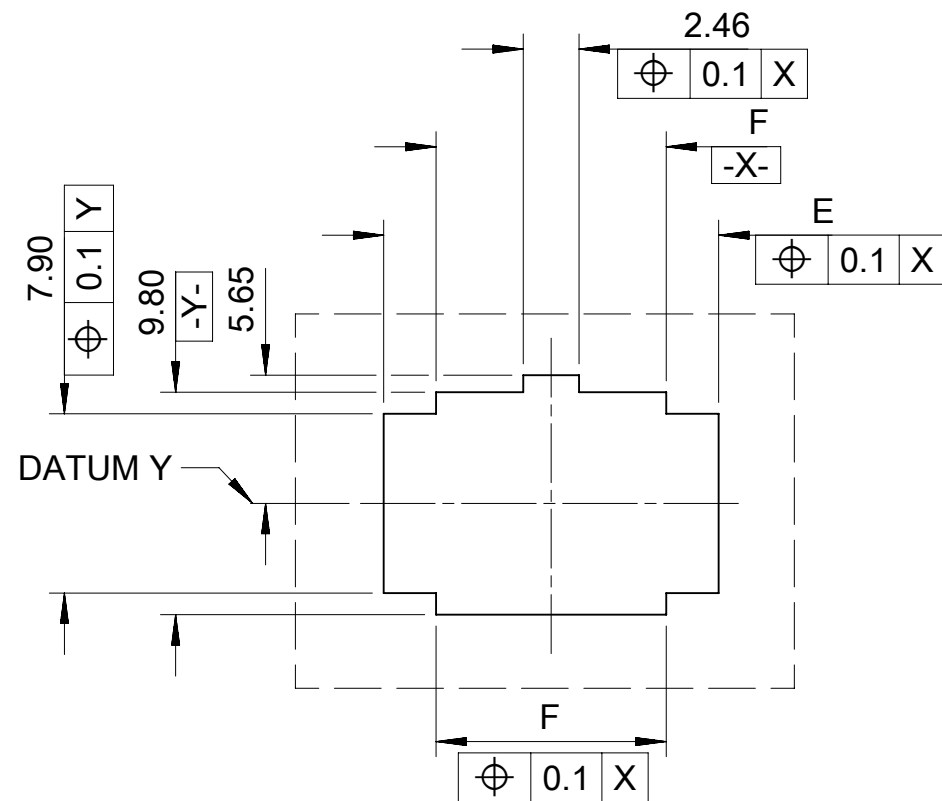

RECOMMENDED PANEL CUT OUT
(TOLERANCE +/-0.05 THICKNESS=1.2~2.2MM)

PART No	DIM 'A'	DIM 'C'	DIM 'D'	DIM 'E'	DIM 'F'	CKT SIZE
215922-0200	3.85	6.25	10.77	8.77	4.15	2
215922-0400	6.85	9.25	13.77	11.77	7.15	4
215922-0600	9.85	12.25	16.77	14.77	10.15	6
215922-0800	12.85	15.25	19.77	17.77	13.15	8
215922-1000	15.85	18.25	22.77	20.77	16.15	10
215922-1200	18.85	21.25	25.77	23.77	19.15	12
215922-1400	21.85	24.25	28.77	26.77	22.15	14
215922-1600	24.85	27.25	31.77	29.77	25.15	16
215922-1800	27.85	30.25	34.77	32.77	28.15	18
215922-2000	30.85	33.25	37.77	35.77	31.15	20
215922-2200	33.85	36.25	40.77	38.77	34.15	22
215922-2400	36.85	39.25	43.77	41.77	37.15	24

FUNCTIONAL SYMBOLS	THIS DRAWING CONTAINS INFORMATION THAT IS PROPRIETARY TO MOLEX ELECTRONIC TECHNOLOGIES, LLC AND SHOULD NOT BE USED WITHOUT WRITTEN PERMISSION	CURRENT REV DESC:						
	DIMENSION UNITS: mm SCALE: 1:1 GENERAL TOLERANCES (UNLESS SPECIFIED) ANGULAR TOL ± ° 4 PLACES ± 3 PLACES ± 2 PLACES ± 0.2 1 PLACE ± 0.3 0 PLACES ±	EC NO: 712744 DRWN: GLLI CHK'D: XQZHANG APPR: XQZHANG						2022/07/01 2022/07/05 2022/07/05
DIVISIONAL SYMBOLS	DRAFT WHERE APPLICABLE MUST REMAIN WITHIN DIMENSIONS		THIRD ANGLE PROJECTION	DRAWING: A3-SIZE	SERIES: 215922	MATERIAL NUMBER:	CUSTOMER: GENERAL MARKET	SHEET NUMBER: 4 OF 6
	PRODUCT CUSTOMER DRAWING		DOCUMENT NUMBER: 2159220000-SD		DOC TYPE: PSD	DOC PART: 000	REVISION: A1	

PANEL MOUNT PLUG PARTS

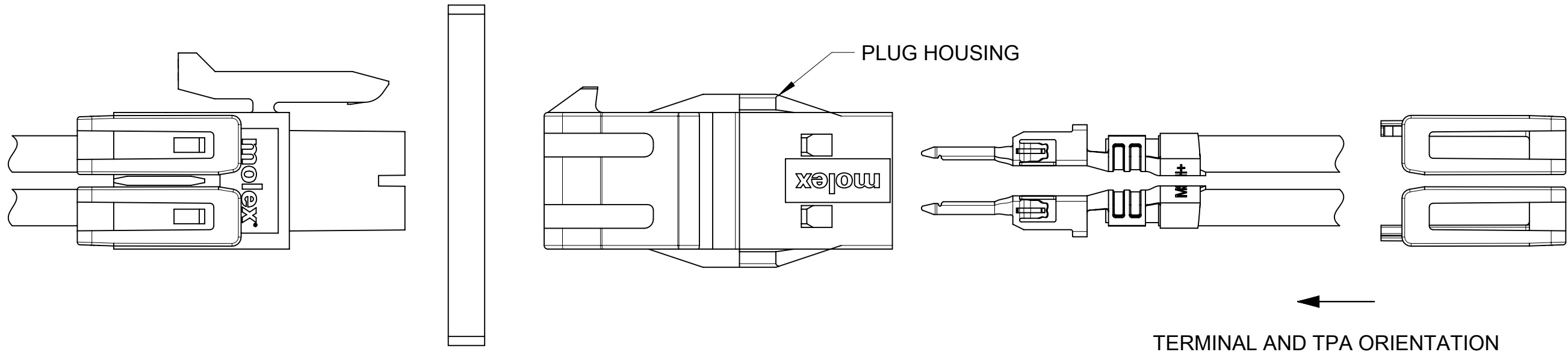
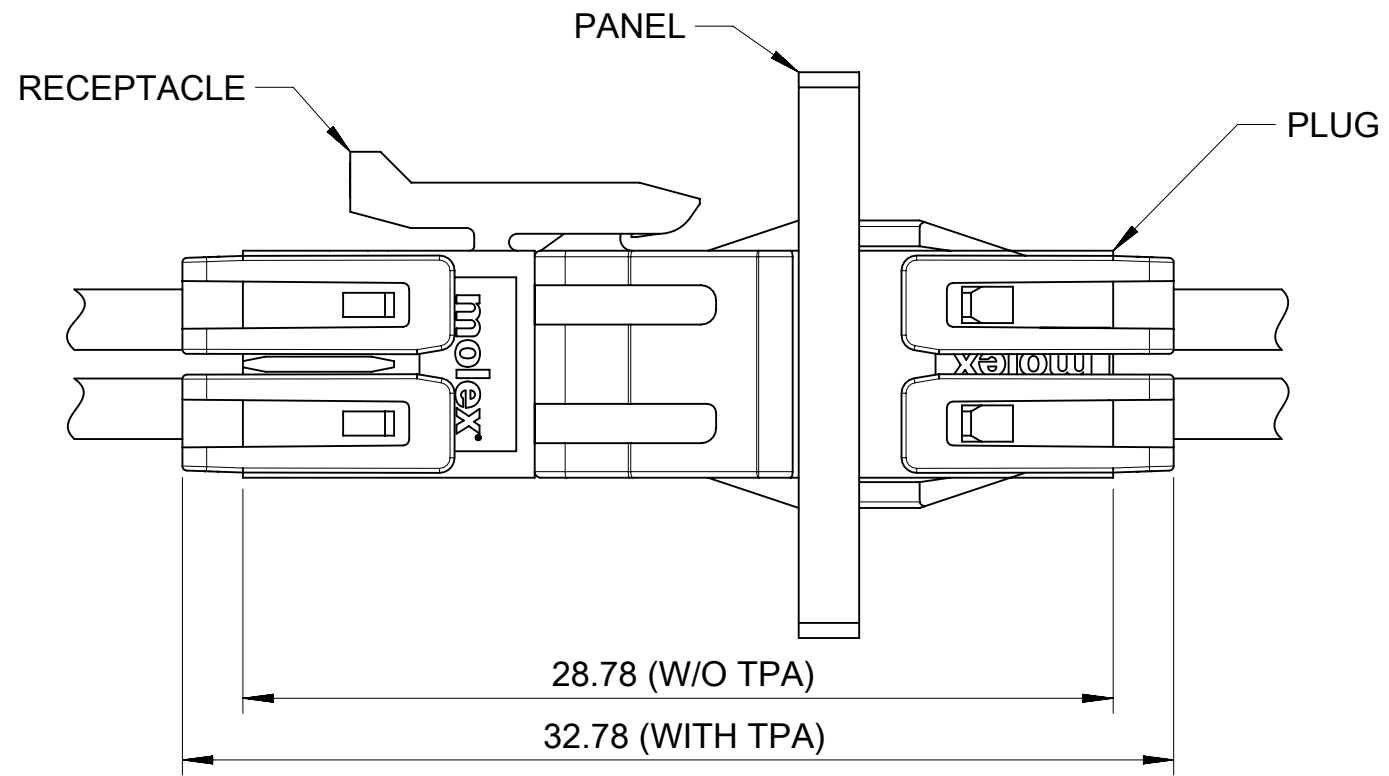

FUNCTIONAL SYMBOLS	THIS DRAWING CONTAINS INFORMATION THAT IS PROPRIETARY TO MOLEX ELECTRONIC TECHNOLOGIES, LLC AND SHOULD NOT BE USED WITHOUT WRITTEN PERMISSION		CURRENT REV DESC:		molex					
	▽A = 0	mm						SCALE 1:1		
▽E = 0	GENERAL TOLERANCES (UNLESS SPECIFIED)		EC NO: 712744 DRWN: GLLI 2022/07/01 CHK'D: XQZHANG 2022/07/05 APPR: XQZHANG 2022/07/05		PLUG HOUSING OF MICRO-FIT PLUS WTW DR POWER CONNECTOR					
▽P = 0	ANGULAR TOL ± °				PRODUCT CUSTOMER DRAWING					
DIVISIONAL SYMBOLS	4 PLACES	±	INITIAL REVISION: DRWN: GLLI 2021/01/29 APPR: XQZHANG 2021/11/15		DOCUMENT NUMBER	DOC TYPE	DOC PART	REVISION		
	3 PLACES	±			2159220000-SD	PSD	000	A1		
	2 PLACES	± 0.2			MATERIAL NUMBER		CUSTOMER		SHEET NUMBER	
	1 PLACE	± 0.3								
0 PLACES	±	DRAFT WHERE APPLICABLE MUST REMAIN WITHIN DIMENSIONS		THIRD ANGLE PROJECTION	DRAWING	SERIES				
						A3-SIZE	215922	GENERAL MARKET	5 OF 6	

PANEL MOUNT PLUG PARTS

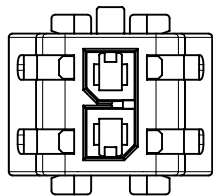

2 CKT

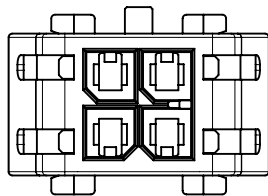

4 CKT

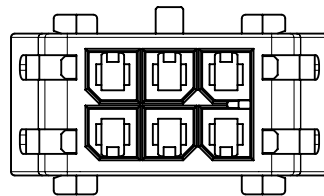

6 CKT

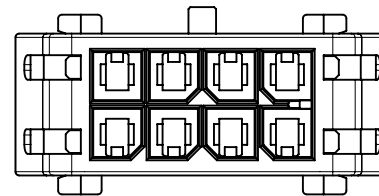

8 CKT

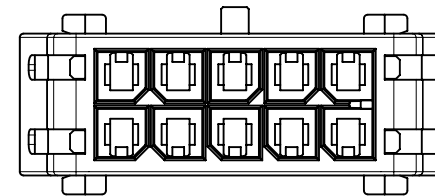

10 CKT

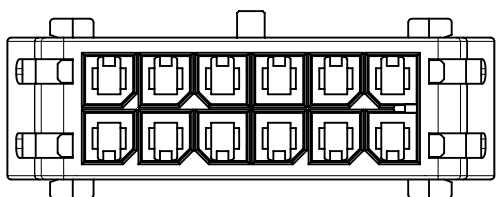

12 CKT

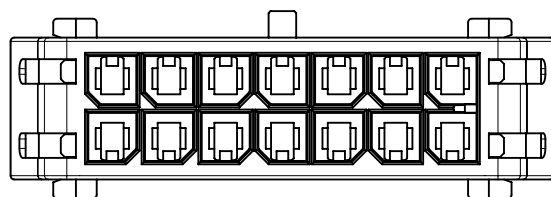

14 CKT

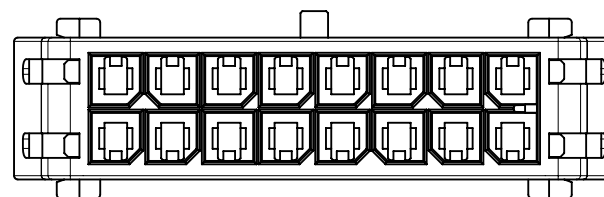

16 CKT

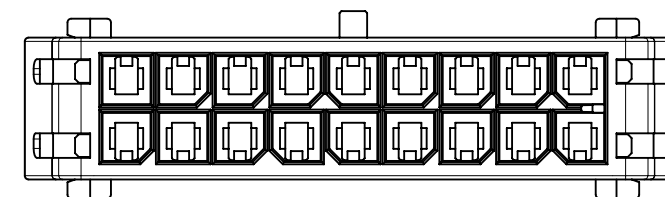

18 CKT

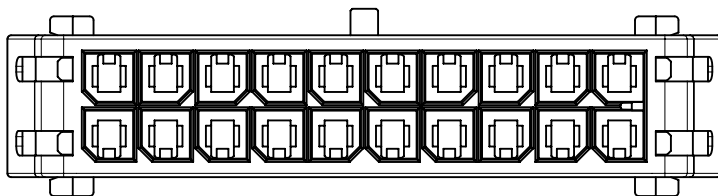

20 CKT

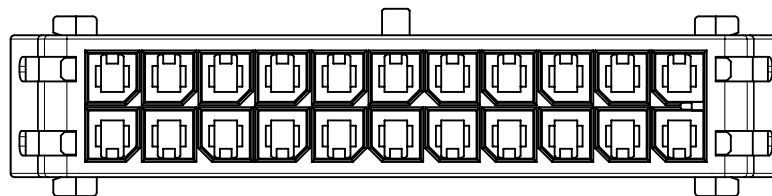

22 CKT

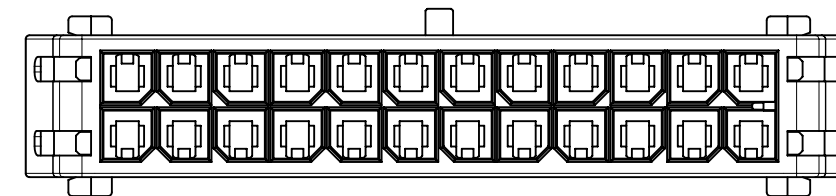

24 CKT

FUNCTIONAL SYMBOLS	THIS DRAWING CONTAINS INFORMATION THAT IS PROPRIETARY TO MOLEX ELECTRONIC TECHNOLOGIES, LLC AND SHOULD NOT BE USED WITHOUT WRITTEN PERMISSION		<div style="text-align: center;">molex</div> <p>PLUG HOUSING OF MICRO-FIT PLUS WTW DR POWER CONNECTOR</p>					
	$\nabla_A = 0$ $\nabla_E = 0$ $\nabla_V = 0$	DIMENSION UNITS: mm SCALE: 1:1					CURRENT REV DESC: EC NO: 712744 DRWN: GLLI CHK'D: XQZHANG APPR: XQZHANG	2022/07/01 2022/07/05 2022/07/05
DIVISIONAL SYMBOLS	GENERAL TOLERANCES (UNLESS SPECIFIED)		INITIAL REVISION:		DOCUMENT NUMBER	DOC TYPE	DOC PART	REVISION
	4 PLACES ± 3 PLACES ± 2 PLACES ± 0.2 1 PLACE ± 0.3 0 PLACES ±	ANGULAR TOL ± °	DRWN: GLLI APPR: XQZHANG	2021/01/29 2021/11/15	2159220000-SD	PSD	000	A1
DRAFT WHERE APPLICABLE MUST REMAIN WITHIN DIMENSIONS		THIRD ANGLE PROJECTION	DRAWING	SERIES	MATERIAL NUMBER	CUSTOMER		SHEET NUMBER
			A3-SIZE	215922		GENERAL MARKET		6 OF 6