

## 300 mA very low dropout linear regulator IC



DFN4 1x1

### Features

- Input voltage from 1.5 to 5.5 V
- Ultra low dropout voltage (300 mV typ. at 300 mA load)
- Very low quiescent current (20  $\mu$ A typ. at no load, 0.03  $\mu$ A typ. in off mode)
- Output voltage tolerance:  $\pm 0.5\%$  (A version) or  $\pm 2.0\%$  @ 25 °C (standard version)
- 300 mA guaranteed output current
- High PSRR (80 dB@1 kHz, 50 dB@100 kHz)
- Wide range of output voltages available on request: from 0.8 V up to 5.0 V in 50 mV step
- Logic-controlled electronic shutdown
- Internal soft-start
- Optional output voltage discharge feature
- Compatible with ceramic capacitor  $C_{OUT} = 0.47\ \mu$ F
- Internal constant current and thermal protections
- Available in DFN4 1x1
- Operating temperature range: -40 °C to 125 °C

### Applications

- Mobile phones
- Tablets
- Digital still cameras (DSC)
- Cordless phones and similar battery-powered systems
- Portable media players

### Description

The LD39030 high accuracy voltage regulator provides 300 mA of maximum current from an input voltage ranging from 1.5 V to 5.5 V, with a typical dropout voltage of 300 mV.

It is available in DFN4 1 x 1 package, allowing the maximum space saving.

The device is stabilized with a ceramic capacitor on the output. The ultra low drop voltage, low quiescent current and low noise features, together with the internal soft-start circuit, make the LD39030 suitable for low power battery-operated applications.

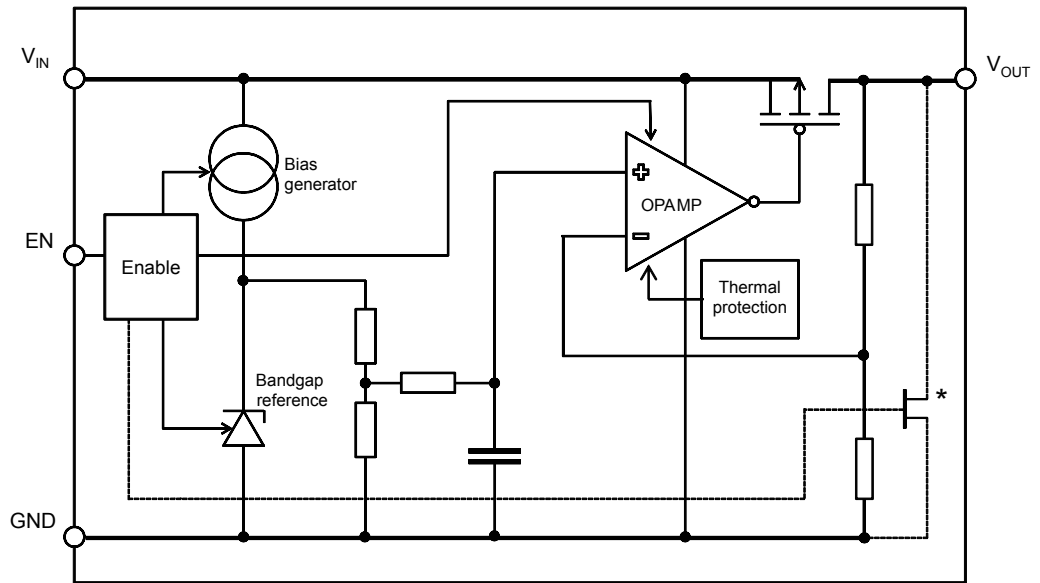
An enable logic control function puts the LD39030 in shutdown mode allowing a total current consumption lower than 0.1  $\mu$ A. Constant current and thermal protection are provided.

Maturity status link

[LD39030](#)

1 Diagram

Figure 2. Block diagram



AM13852V1

Note: The output discharge MOSFET is optional.

## 2 Pin configuration

Figure 3. Pin connection (top view)

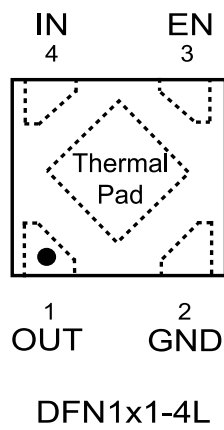
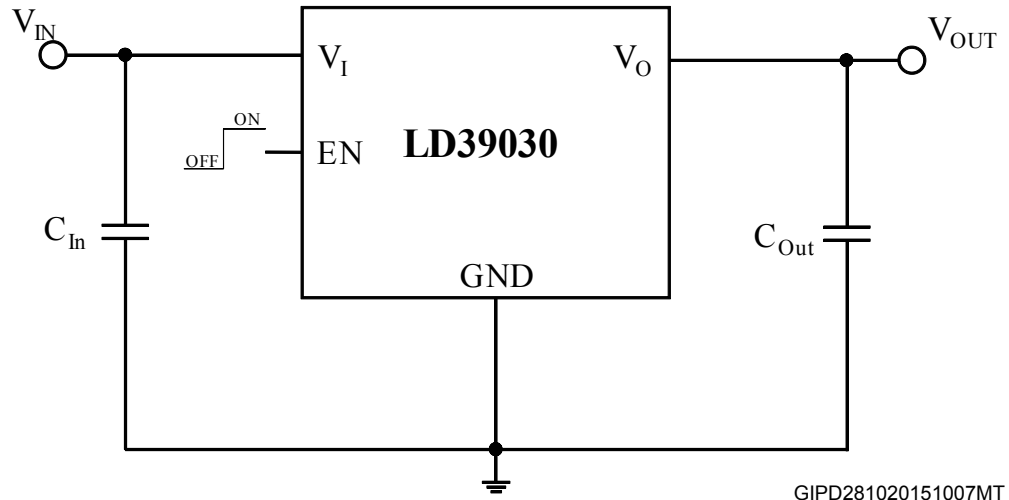


Table 1. Pin description

Pin n° DFN4 1x1	Symbol	Function
1	OUT	Output voltage
2	GND	Common ground
3	EN	Enable pin logic input: Low = shutdown, High = active
4	IN	Input voltage
Thermal pad	GND	Connect to GND on the PCB

### 3 Typical application

Figure 4. Typical application circuits



## 4 Maximum ratings

**Table 2. Absolute maximum ratings**

Symbol	Parameter	Value	Unit
$V_{IN}$	Input voltage	- 0.3 to 7	V
$V_{OUT}$	Output voltage	- 0.3 to $V_{IN} + 0.3$	V
$V_{EN}$	Enable input voltage	- 0.3 to 7	V
$I_{OUT}$	Output current	Internally limited	mA
$P_D$	Power dissipation	Internally limited	mW
$T_{STG}$	Storage temperature range	- 40 to 150	°C
$T_{OP}$	Operating junction temperature range	- 40 to 125	°C

*Note:* Absolute maximum ratings are those values beyond which damage to the device may occur. Functional operation under these conditions is not implied. All values are referred to GND.

**Table 3. Thermal data**

Symbol	Parameter	Value	Unit
$R_{thJA}$	Thermal resistance junction-ambient	250	°C/W

**Table 4. ESD Performance**

Symbol	Parameter	Test conditions	Value	Unit
ESD	ESD Protection voltage	HBM	4	kV
		MM	400	V
		CDM	500	V

## 5 Electrical characteristics

$T_J = 25\text{ °C}$ ,  $V_{IN} = V_{OUT(NOM)} + 1\text{ V}$ ,  $C_{IN} = C_{OUT} = 1\text{ }\mu\text{F}$ ,  $I_{OUT} = 1\text{ mA}$ ,  $V_{EN} = V_{IN}$ , unless otherwise specified.

**Table 5. Electrical characteristics**

Symbol	Parameter	Test conditions	Min.	Typ.	Max.	Unit
$V_{IN}$	Operating input voltage		1.5		5.5	V
$V_{OUT}$	$V_{OUT}$ accuracy (LD39030)	$I_{OUT} = 1\text{ mA}$ , $T_J = 25\text{ °C}$	-2		2	%
		$I_{OUT} = 1\text{ mA}$ , $-40\text{ °C} < T_J < 125\text{ °C}$	-3		3	%
$V_{OUT}$	$V_{OUT}$ accuracy (LD39030A)	$I_{OUT} = 1\text{ mA}$ , $T_J = 25\text{ °C}$	-0.5		0.5	%
		$I_{OUT} = 1\text{ mA}$ , $-40\text{ °C} < T_J < 125\text{ °C}$	-1.5		1.5	%
$\Delta V_{OUT}$	Static line regulation <sup>(1)</sup>	$V_{OUT(NOM)} + 1\text{ V} \leq V_{IN} \leq 5.5\text{ V}$ , $I_{OUT} = 10\text{ mA}$		0.02		%V
		$-40\text{ °C} < T_J < 125\text{ °C}$			0.2	
$\Delta V_{OUT}$	Static load regulation	$I_{OUT} = 0\text{ mA}$ to $300\text{ mA}$		18		mV
		$-40\text{ °C} < T_J < 125\text{ °C}$			0.01	%/mA
$V_{DROP}$	Dropout voltage	$I_{OUT} = 30\text{ mA}$ , $V_{OUT} = 2.8\text{ V}$		35		mV
		$I_{OUT} = 300\text{ mA}$ , $V_{OUT} = 2.8\text{ V}$ $-40\text{ °C} < T_J < 125\text{ °C}$		330		
$e_N$	Output noise voltage	10 Hz to 100 kHz, $I_{OUT} = 10\text{ mA}$		45		$\mu\text{VRMS/V}$
SVR	Supply voltage rejection	$V_{IN} = V_{OUT(NOM)} + 1\text{ V} \pm V_{RIPPLE}$ $V_{RIPPLE} = 0.2\text{ V}$ Freq. = 1 kHz $I_{OUT} = 30\text{ mA}$		80		dB
		$V_{IN} = V_{OUT(NOM)} + 1\text{ V} \pm V_{RIPPLE}$ $V_{RIPPLE} = 0.2\text{ V}$ Freq. = 100 kHz $I_{OUT} = 30\text{ mA}$		55		
$I_Q$	Quiescent current	$I_{OUT} = 0\text{ mA}$		20	40	$\mu\text{A}$
		$I_{OUT} = 300\text{ mA}$		130		
$I_{Standby}$	Standby Current	$V_{IN}$ input current in OFF MODE: $V_{EN} = \text{GND}$		0.03	1	$\mu\text{A}$
$I_{SC}$	Short circuit current	$R_L = 0$		480		mA
$R_{ON}$	Output voltage discharge MOSFET	(only on LD39030DT, LD39030ADT)		100		$\Omega$

Symbol	Parameter	Test conditions	Min.	Typ.	Max.	Unit
$V_{EN}$	Enable input logic low	$V_{IN} = 1.5\text{ V to }5.5\text{ V}$ $-40\text{ }^{\circ}\text{C} < T_J < 125\text{ }^{\circ}\text{C}$			0.4	V
	Enable input logic high	$V_{IN} = 1.5\text{ V to }5.5\text{ V}$ $-40\text{ }^{\circ}\text{C} < T_J < 125\text{ }^{\circ}\text{C}$	1			
$I_{EN}$	Enable pin input current	$V_{EN} = V_{IN}$			100	nA
$T_{ON}^{(2)}$	Turn on time			100		$\mu\text{s}$
$T_{SHDN}$	Thermal shutdown			160		$^{\circ}\text{C}$
	Hysteresis			20		
$C_{OUT}$	Output capacitor	Capacitance (see ) <a href="#">Figure 18. Stability area vs. (<math>C_{OUT}</math>, ESR)</a>	0.47		22	$\mu\text{F}$

1. Not applicable for  $V_{OUT(NOM)} > 4.5\text{ V}$

2. Turn-on time is time measured between the enable input just exceeding  $V_{EN}$  high value and the output voltage just reaching 95 % of its nominal value

## 6 Application information

### 6.1 Soft start function

The LD39030 has an internal soft start circuit. By increasing the startup time up to 100 $\mu$ s, without the need of any external soft start capacitor, this feature is able to keep the regulator inrush current at startup under control.

### 6.2 Output discharge function

The LD39030 integrates a MOSFET connected between Vout and GND. This transistor is activated when the EN pin goes to low logic level and has the function to quickly discharge the output capacitor when the device is disabled by the user.

The device is available with or without auto-discharge feature.

See [Section 9 Ordering information](#) for more details.

### 6.3 Input and output capacitors

The LD39030 requires external capacitors to assure the regulator control loop stability.

Any good quality ceramic capacitor can be used but, the X5R and the X7R are suggested since they guarantee a very stable combination of capacitance and ESR overtemperature.

Locating the input/output capacitors as closer as possible to the relative pins is recommended.

The LD39030 requires an input capacitor with a minimum value of 1  $\mu$ F.

This capacitor must be located as closer as possible to the input pin of the device and returned to a clean analog ground.

The control loop of the LD39030 is designed to work with an output ceramic capacitor.

This capacitor must meet the requirements of minimum capacitance and equivalent series resistance (ESR), as shown in [Figure 18. Stability area vs. \(C<sub>OUT</sub>, ESR\)](#). To assure stability, the output capacitor must maintain its ESR and capacitance in the stable region, over the full operating temperature range.

The LD39030 shows stability with a minimum effective output capacitance of 220 nF.

However, to keep stability in all operating conditions (temperature, input voltage and load variations), a minimum output capacitor of 0.47  $\mu$ F is recommended.

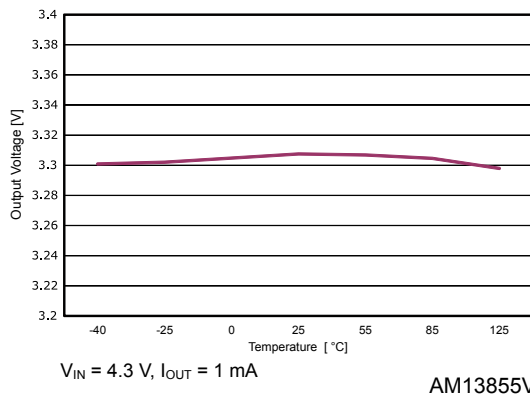
The suggested combination of 1  $\mu$ F input and output capacitors offers a good compromise among the stability of the regulator, optimum transient response and total PCB area occupation.



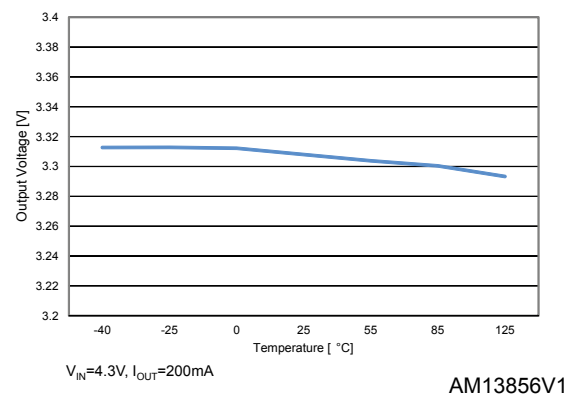
## 7 Typical characteristics

( $C_{IN} = C_{OUT} = 1 \mu F$ ,  $V_{EN}$  to  $V_{IN}$ ,  $T_J = 25^\circ C$  unless otherwise specified)

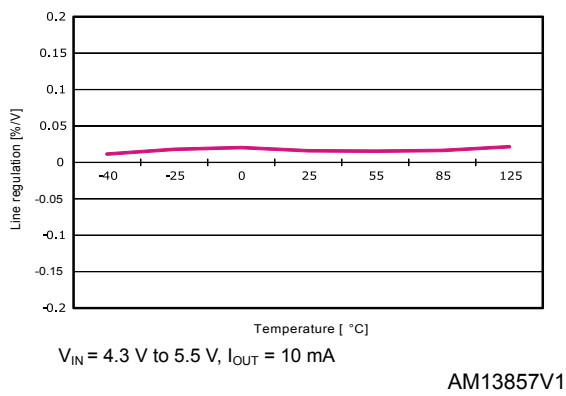
**Figure 5. Output voltage vs. temperature ( $I_{OUT} = 1 \text{ mA}$ )**



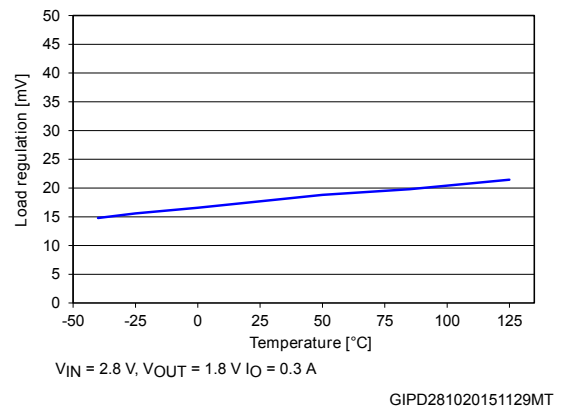
**Figure 6. Output voltage vs. temperature ( $I_{OUT} = 200 \text{ mA}$ )**

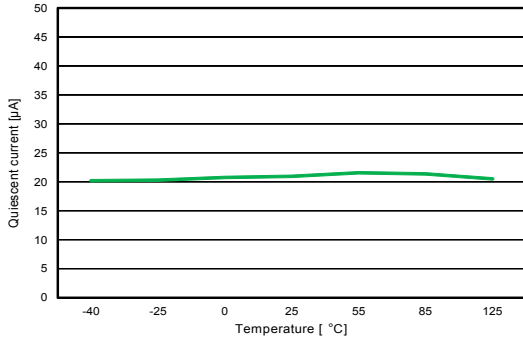


**Figure 7. Line regulation vs. temperature**

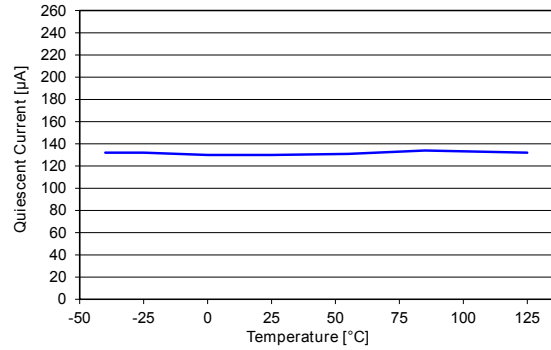


**Figure 8. Load regulation vs. temperature**

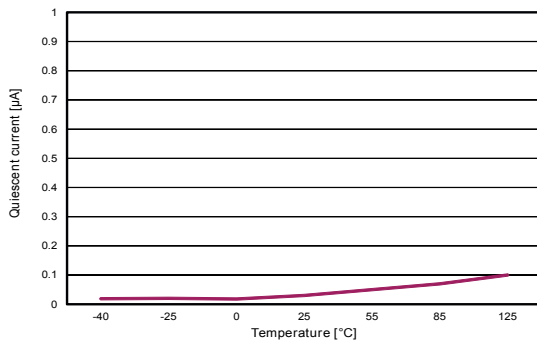


**Figure 9. Quiescent current vs. temperature ( $I_{OUT} = 0$  mA)**

 $V_{IN} = 4.3$  V,  $I_{OUT} = 0$  mA

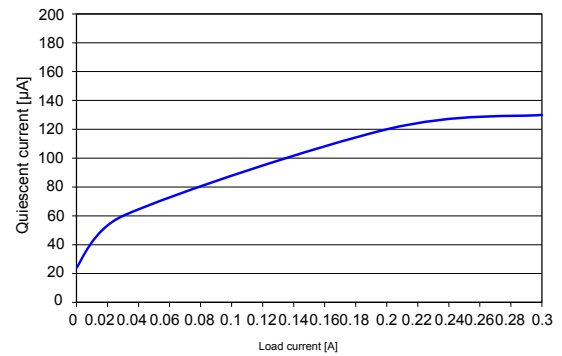
AM13859V1

**Figure 10. Quiescent current vs. temperature ( $I_{OUT} = 200$  mA)**

 $V_{IN} = 2.8$  V,  $V_{OUT} = 1.8$  V  $I_O = 0.3$  A

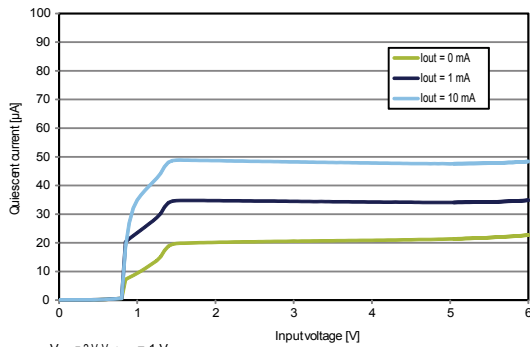
GIPD281020151212MT

**Figure 11. Shutdown current vs. temperature**

 $V_{IN} = V$ ,  $V_{EN} = GND$ 

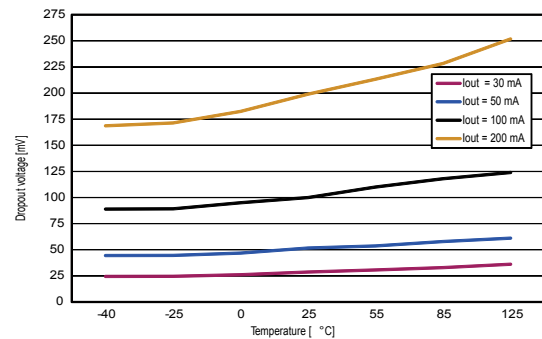
AM13861V1

**Figure 12. Quiescent current vs. load current**

 $V_{IN} = 2.8$  V,  $V_{OUT} = 1.8$  V  $I_O = 0$  to 0.3 A

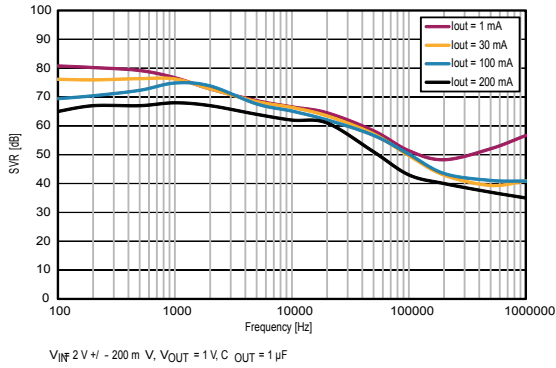
GIPD281020151230MT

**Figure 13. Quiescent current vs. input voltage**

 $V_{IN} = 2$  V,  $V_{OUT} = 1$  V

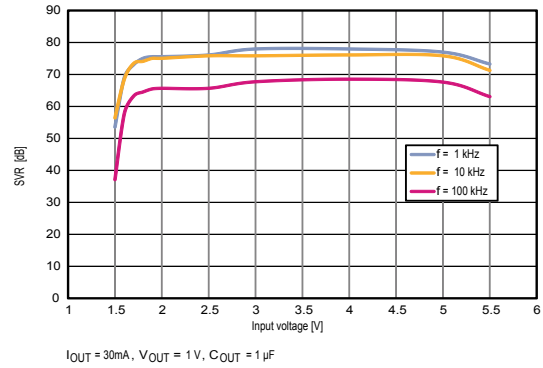
AM13863V1

**Figure 14. Dropout voltage vs. temperature**


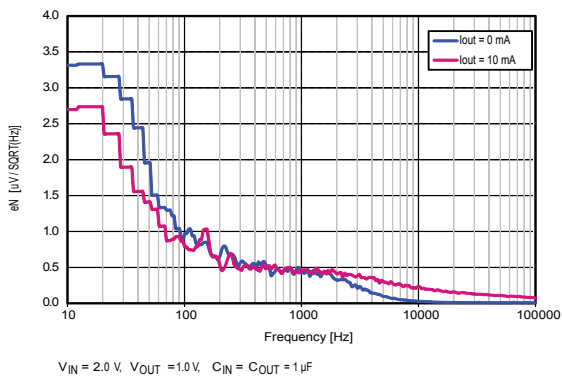
AM13864V1

**Figure 15. Supply voltage rejection vs. frequency**


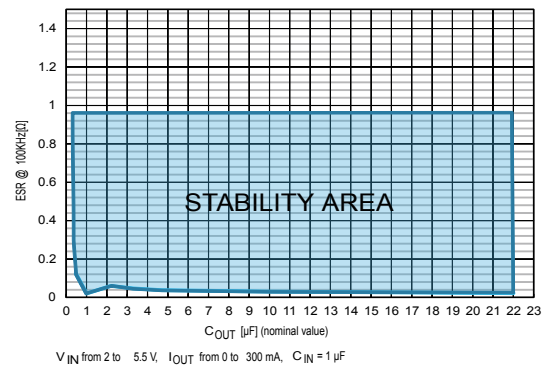
AM13865V1

**Figure 16. Supply voltage rejection vs. input voltage**


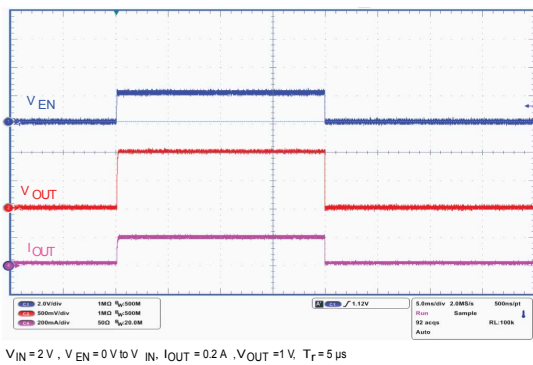
AM13866V1

**Figure 17. Output noise spectral density**


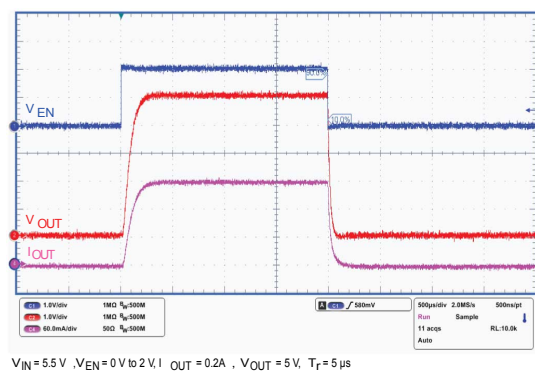
AM13867V1

**Figure 18. Stability area vs. (COUT, ESR)**


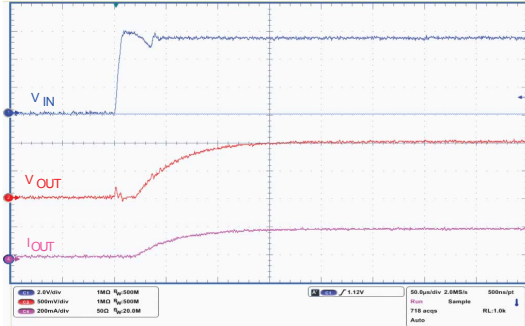
AM13868V1

**Figure 19. Enable startup (VOUT = 1 V)**


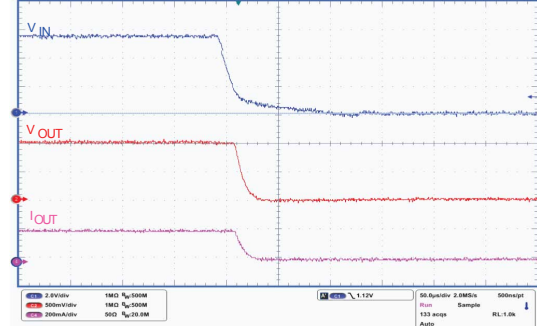
AM13869V1

**Figure 20. Enable startup (VOUT = 5 V)**


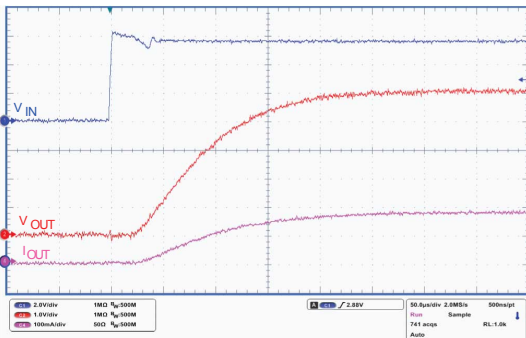
AM13870V1

**Figure 21. Turn-on time ( $V_{OUT} = 1\text{ V}$ )**

 $V_{IN} = V_{EN}$  = from 0 V to 5.5 V,  $I_{OUT} = 0.2\text{ A}$ ,  $V_{OUT} = 1\text{ V}$ ,  $T_r = 5\text{ }\mu\text{s}$ 

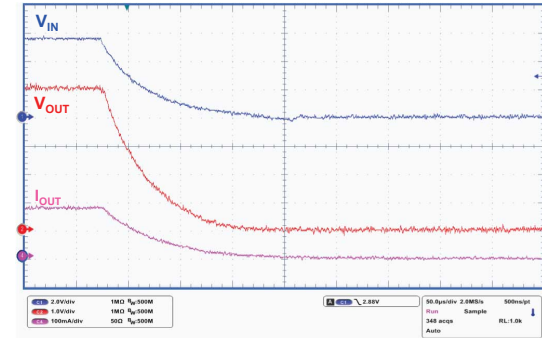
AM13871V1

**Figure 22. Turn-off time ( $V_{OUT} = 1\text{ V}$ )**

 $V_{IN} = V_{EN}$  = from 5.5 V to 0 V,  $I_{OUT} = 0.2\text{ A}$ ,  $V_{OUT} = 1\text{ V}$ ,  $T_f = 5\text{ }\mu\text{s}$ 

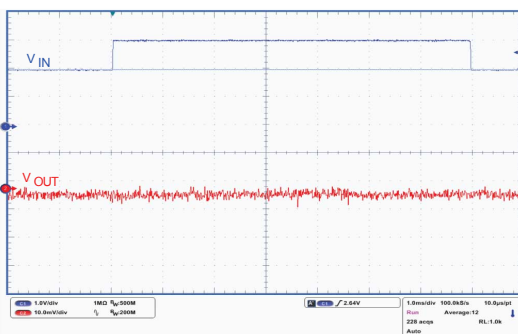
AM13872V1

**Figure 23. Turn-on time ( $V_{OUT} = 5\text{ V}$ )**

 $V_{IN} = V_{EN}$  = from 0 V to 5.5 V,  $I_{OUT} = 0.2\text{ A}$ ,  $V_{OUT} = 5\text{ V}$ ,  $T_r = 5\text{ }\mu\text{s}$ 

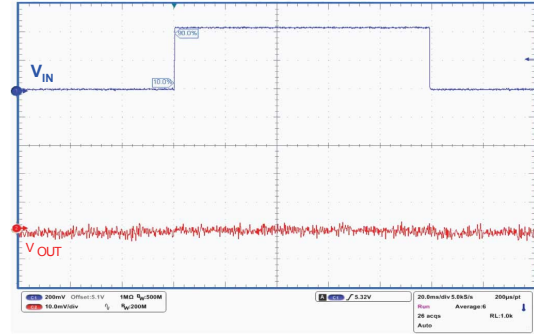
AM13873V1

**Figure 24. Turn-off time ( $V_{OUT} = 5\text{ V}$ )**

 $V_{IN} = V_{EN}$  = from 5.5 V to 0 V,  $I_{OUT} = 0.2\text{ A}$ ,  $V_{OUT} = 5\text{ V}$ ,  $T_f = 5\text{ }\mu\text{s}$ 

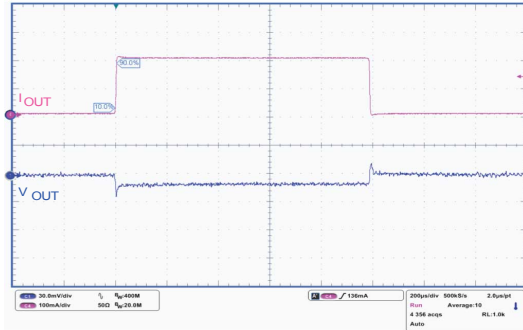
AM13874V1

**Figure 25. Line transient ( $V_{OUT} = 1\text{ V}$ )**

 $V_{IN} = V_{EN}$  = from 2 V to 3 V,  $I_{OUT} = 10\text{ mA}$ ,  $V_{OUT} = 1\text{ V}$ ,  $T_r = T_f = 5\text{ }\mu\text{s}$ 

AM13875V1

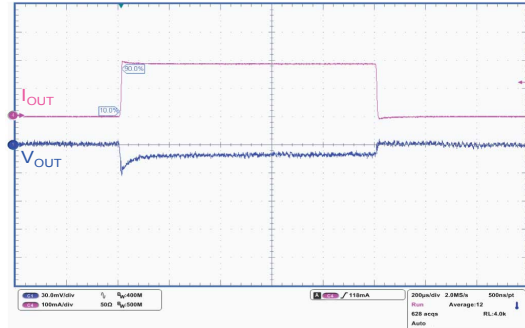
**Figure 26. Line transient ( $V_{OUT} = 5\text{ V}$ )**

 $V_{IN} = V_{EN}$  = from 5.1 V to 5.5 V,  $I_{OUT} = 10\text{ mA}$ ,  $V_{OUT} = 5\text{ V}$ ,  $T_r = T_f = 5\text{ }\mu\text{s}$ 

AM13876V1

**Figure 27. Load transient ( $V_{OUT} = 1\text{ V}$ )**


$V_{IN} = V_{EN} = 2\text{ V}$ ,  $I_{OUT}$  = from 0 to 0.2 A,  $V_{OUT} = 1\text{ V}$ ,  $t_f = 5\ \mu\text{s}$

AM13877V1

**Figure 28. Load transient ( $V_{OUT} = 5\text{ V}$ )**


$V_{IN} = V_{EN} = 5.5\text{ V}$ ,  $I_{OUT}$  = from 0 to 0.2 A,  $V_{OUT} = 5\text{ V}$ ,  $t_f = 5\ \mu\text{s}$

AM13878V1

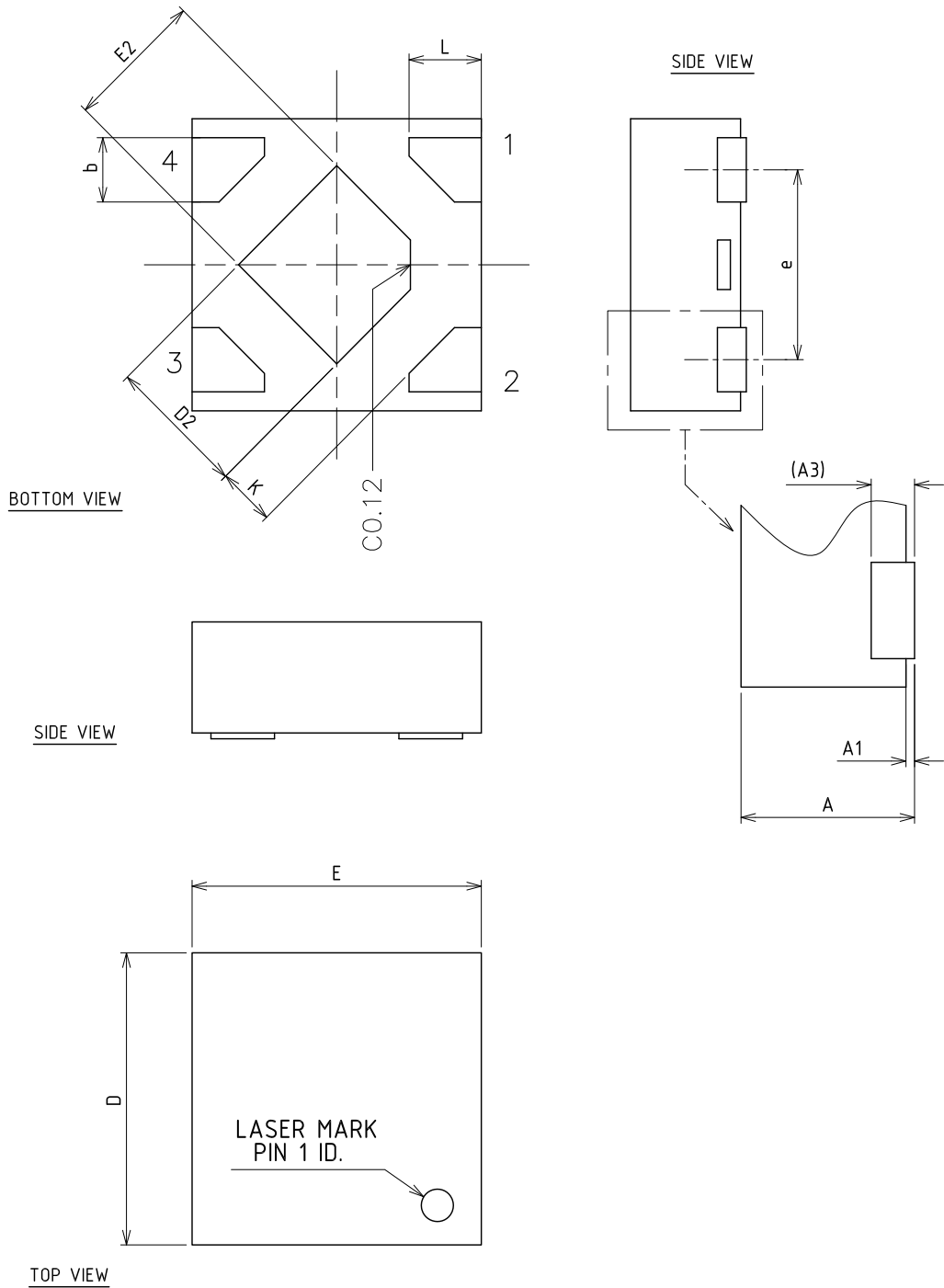
## **8 Package information**

---

In order to meet environmental requirements, ST offers these devices in different grades of ECOPACK® packages, depending on their level of environmental compliance. ECOPACK® specifications, grade definitions and product status are available at: [www.st.com](http://www.st.com). ECOPACK® is an ST trademark.

### 8.1 DFN4 1x1 package information

Figure 29. DFN4 1x1 package outline



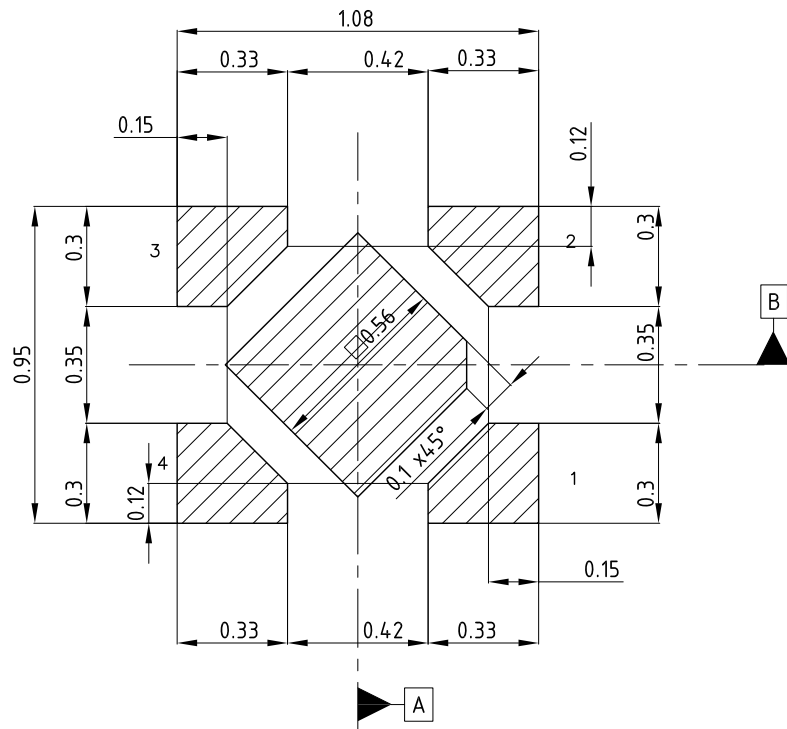
8405587\_A

**Table 6. DFN4 1x1 mechanical data**

Dim.	mm.		
	Min.	Typ.	Max.
A	0.34	0.37	0.40
A1	0	0.02	0.05
A3		0.10	
b	0.17	0.22	0.27
D	0.95	1.00	1.05
D2	0.43	0.48	0.53
E	0.95	1.00	1.05
E2	0.43	0.48	0.53
e		0.65	
L	0.20	0.25	0.30
K	0.15		



Figure 30. DFN4 1x1 recommended footprint



Notes:

- 1) This footprint is able to ensure insulation up to 10 Vrms (according to CEI IEC 664-1)
- 2) The device must be positioned within  $\oplus 0.02$  A B

8405587\_A

## 9 Ordering information

**Table 7. Order code**

Order code	Output voltage (V)	Auto-dishcharge	Tolerance %	Marking
LD39030DTPU12R <sup>(1)</sup>	1.2	Yes	2	X5
LD39030ADTPU12R			0.5	W5
LD39030DTPU18R	1.8	Yes	2	X7
LD39030ADTPU18R			0.5	W7
LD39030DTPU25R <sup>(1)</sup>	2.5	Yes	2	XA
LD39030ADTPU25R <sup>(1)</sup>			0.5	WA
LD39030DTPU28R	2.8	Yes	2	XC
LD39030ADTPU28R			0.5	WC
LD39030DTPU30R V	3.0	Yes	2	XF
LD39030ADTPU30R V			0.5	WF
LD39030DTPU33R	3.3	Yes	2	XJ

1. Available on request.

## Revision history

**Table 8. Document revision history**

Date	Revision	Changes
16-Nov-2015	1	Initial release.
18-May-2016	2	Updated <i>Section 9: "Ordering information"</i> . Minor text changes.
30-Aug-2016	3	Updated Ordering information. Minor text changes.
17-May-2018	4	Updated: $V_{OUT}$ parameter <a href="#">Table 5. Electrical characteristics</a> and <a href="#">Section 9 Ordering information</a> .

**IMPORTANT NOTICE – PLEASE READ CAREFULLY**

STMicroelectronics NV and its subsidiaries (“ST”) reserve the right to make changes, corrections, enhancements, modifications, and improvements to ST products and/or to this document at any time without notice. Purchasers should obtain the latest relevant information on ST products before placing orders. ST products are sold pursuant to ST’s terms and conditions of sale in place at the time of order acknowledgement.

Purchasers are solely responsible for the choice, selection, and use of ST products and ST assumes no liability for application assistance or the design of Purchasers’ products.

No license, express or implied, to any intellectual property right is granted by ST herein.

Resale of ST products with provisions different from the information set forth herein shall void any warranty granted by ST for such product.

ST and the ST logo are trademarks of ST. All other product or service names are the property of their respective owners.

Information in this document supersedes and replaces information previously supplied in any prior versions of this document.

© 2018 STMicroelectronics – All rights reserved