



Modicon TM7

High-Performance and Safe IP67
distributed I/O System



Modicon

Discover Modicon

Industrial Edge control for IIoT

Modicon IIoT-native edge controllers manage complex interfaces across assets and devices or directly into the cloud, with embedded safety and cybersecurity. Modicon provides performance and scalability for a wide range of industrial applications up to high-performance multi-axis machines and high-available redundant processes.

Explore our offer

- Modicon HVAC Controllers
- Modicon PLC
- Modicon Motion Controllers
- Modicon PAC
- Modicon I/O
- Modicon Networking
- Modicon Power Supply
- Modicon Wiring
- Modicon Safety

Life Is On



General content

Modicon® TM7

High-Performance and Safe IP67 Distributed I/O System

<i>Introduction to EcoStruxure® Machine</i>	<i>page 2</i>
<i>Selection guide: controllers for industrial machines</i>	<i>page 4</i>
<i>Machine automation</i>	<i>page 6</i>
■ Range presentation	<i>page 8</i>
■ Modicon TM7 expansion system	<i>page 9</i>
■ Diagnostic functions	<i>page 9</i>
■ Digital I/O blocks	
<i>Selection guide</i>	<i>page 10</i>
- Description	<i>page 12</i>
- References	<i>page 13</i>
■ Analog I/O blocks	
<i>Selection guide</i>	<i>page 14</i>
- Description	<i>page 16</i>
- References	<i>page 17</i>
■ Power distribution blocks	
- Description	<i>page 18</i>
- References	<i>page 18</i>
■ Safety I/O blocks	
- Description	<i>page 19</i>
- References	<i>page 19</i>
■ CANopen interface blocks	
<i>Selection guide</i>	<i>page 20</i>
- Presentation	<i>page 22</i>
- Description	<i>page 24</i>
- References	<i>page 25</i>
■ Connection components: CANopen and TM7 bus architectures	
- Architectures	<i>page 26, page 27, page 28</i>
- References	<i>page 26, page 27, page 28</i>
■ Separate parts	<i>page 29</i>
■ Product References index	<i>page 30</i>

To be competitive in today's digital era, machine builders must be innovative. Smart machines, those that are better connected, more flexible, more efficient, and safe, are enabling machine builders to innovate in ways never before possible.

EcoStruxure, Schneider Electric's open, IoT-enabled architecture and platform, offers powerful solutions for the digital era. As part of this, EcoStruxure Machine brings powerful opportunities for machine builders and OEMs, empowering them to offer smart machines and compete in the new, digital era.

EcoStruxure Machine brings together key technologies for product connectivity and edge control on premises, and cloud technologies to provide analytics and digital services. EcoStruxure Machine helps you bring more innovation and added value to your customers throughout the entire machine life cycle.

Innovation at Every Level for Machines is full systems across three layers:

- Connected products
Our connected products for measuring, actuating, device level monitoring, and control adhere to open standards to provide unmatched integration opportunities and flexibility
- Edge Control
We are IIoT-ready with a proven set of tested and validated reference architectures that enable the design of end-to-end open, connected, and interoperable systems based on industry standards. Ethernet and OPC UA facilitates IT/OT convergence meaning machine builders reap benefits from web interfaces and cloud.

- Apps, Analytics & Services
Seamless integration of machines to the IT layer allows the collection and aggregation of data ready for analysis – for machine builders and end users alike this means increased uptime and the ability to find information faster for more efficient operations and maintenance.

These levels are completely integrated from shop floor to top floor. And we have cloud offers and end-to-end cybersecurity wrapped around.

EcoStruxure Machine makes it easier for OEMs/ machine builders to offer their customers smarter machines. The advent of smart machines is driven by the changing needs of end users:

- Evolving workforce
- Reducing costs
- Dynamic markets
- Shorter life cycles
- Prioritizing safety and cybersecurity

EcoStruxure Machine provides one solution for the whole machine life cycle:

- With Smart Design & Engineering the time to market is reduced by up to 30% using our automated engineering and the simulation capabilities
- During Commissioning & Operation of the machine, resources such as energy, material and loss can be improved, and with seamless integration to the IT world efficiency can be improved by up to 40%
- Smart Maintenance & Services reduces the time for corrective actions up to 50%

EcoStruxure™ Machine





Innovation At Every Level



* The Schneider Electric industrial software business and AVEVA have merged to trade as AVEVA Group plc, a UK listed company. The Schneider Electric and Life is On trademarks are owned by Schneider Electric and are being licensed to AVEVA by Schneider Electric.

Modicon TM7

High-Performance and Safe IP67 Distributed I/O System
Controllers for industrial machines

Applications	Type	Logic controller			Logic/Motion controller		Motion controller
	Specification	For hardwired architectures	For performance-demanding applications		For modular and distributed architectures	IIoT ready for performance machines	For automating machines/lines with 0 - 130 servo or robot axes
							
Performance		0.2 µs/inst	22 ns/inst		22 ns/inst	3...5 ns/inst	0.5...2 ns/inst
Memory		640 KB RAM, 2 MB Flash	64 MB RAM, 128 MB Flash		64 MB RAM, 128 MB Flash	256 MB RAM, 256 MB Flash	128 KB to 256 KB NV RAM 512 MB DDR2 to 1 GB DDR3L
Supply voltage		24 V --- or 100...240 V ~	24 V --- or 100...240 V ~		24 V ---	24 V ---	24 V ---
Communication fieldbus and networks	Embedded	<ul style="list-style-type: none"> ■ EtherNet/IP ■ RS 232/RS 485 serial link ■ USB mini-B programming port 	<ul style="list-style-type: none"> ■ Ethernet ■ CANopen (master) and SAE J1939 ■ 2 serial links ■ USB mini-B programming port 		<ul style="list-style-type: none"> ■ EtherNet/IP ■ CANopen (master) and SAE J1939 ■ Serial link ■ USB mini-B programming port 	<ul style="list-style-type: none"> ■ EtherNet/IP ■ Sercos III ■ Modbus TCP ■ Serial link ■ USB mini-B programming port 	<ul style="list-style-type: none"> ■ EtherNet/IP ■ Sercos III ■ CANopen ■ Profibus ■ Profinet ■ EtherCAT
	Optional	<ul style="list-style-type: none"> ■ 1 Serial Line 	<ul style="list-style-type: none"> ■ Ethernet ■ Profibus DP 		<ul style="list-style-type: none"> ■ Ethernet ■ Profibus DP 	<ul style="list-style-type: none"> ■ Ethernet ■ CANopen 	<ul style="list-style-type: none"> ■ CANopen ■ Profibus DP ■ RT-Ethernet
Embedded I/O	Input types	Up to 40 logic inputs Up to 2 analog inputs	Up to 24 logic inputs		–	4 fast digital inputs	Up to 20 digital inputs Up to 16 touch probe inputs Up to 4 interrupt inputs Up to 2 analog inputs
	Output types	Up to 16 relay outputs Up to 16 transistor outputs	Up to 16 transistor outputs		–	4 fast digital outputs	Up to 16 digital outputs Up to 2 analog outputs
Synchronized axes		–	–		–	Up to 16 synchronized axes	Up to 130 synchronized axes
Configuration software		EcoStruxure Machine Expert-Basic (1)	EcoStruxure Machine Expert V1.1 (2)		EcoStruxure Machine Expert V1.1 (2)	EcoStruxure Machine Expert V1.1	EcoStruxure Machine Expert V1.1 (2)
Compatible expansion I/O module ranges (consult the catalog)	Local I/O	● Modicon TM3 (DIA3ED2140109EN)	● Modicon TM3 (DIA3ED2140109EN)		● Modicon TM3 (DIA3ED2140109EN)	● Modicon TM3 (DIA3ED2140109EN)	–
	Remote I/O	● Modicon TM3 (DIA3ED2140109EN)	● Modicon TM3 (DIA3ED2140109EN)		● Modicon TM3 (DIA3ED2140109EN)	● Modicon TM3 (DIA3ED2140109EN)	–
	Distributed I/O on Ethernet	● Modicon TM3 (DIA3ED2140109EN)	● Modicon TM3 (DIA3ED2140109EN) ● Modicon TM5 (DIA3ED2131204EN)		● Modicon TM3 (DIA3ED2140109EN) ● Modicon TM5 (DIA3ED2131204EN)	● Modicon TM3 (DIA3ED2140109EN) ● Modicon TM5 (DIA3ED2131204EN)	● Modicon TM5 (DIA3ED2131204EN)
	Distributed I/O on CANopen	–	–		–	● Modicon TM5 (DIA3ED2131204EN) ● Modicon TM7 (DIA3ED2140405EN)	● Modicon TM5 (DIA3ED2131204EN) ● Modicon TM7 (DIA3ED2140405EN)
	Distributed I/O on Sercos	–	–		–	● Modicon TM5 (DIA3ED2131204EN)	● Modicon TM5 (DIA3ED2131204EN)
	Safety I/O	⚡ Modicon TM3 (DIA3ED2140109EN)	⚡ Modicon TM3 (DIA3ED2140109EN)		⚡ Modicon TM3 (DIA3ED2140109EN)	⚡ Modicon TM3 (DIA3ED2140109EN) ⚡ Modicon TM5 (DIA3ED2131204EN) ⚡ Modicon TM7 (DIA3ED2140405EN)	⚡ Modicon TM5 (DIA3ED2131204EN) ⚡ Modicon TM7 (DIA3ED2140405EN)
Controller range	Modicon M221/M221 Book	Modicon M241		Modicon M251	Modicon M262	LMC Eco, LMC Pro2	
More details in catalog	DIA3ED2140106EN	DIA3ED2140107EN		DIA3ED2140108EN	DIA3ED2180503EN	DIA7ED2160303EN	

(1) Formerly named SoMachine Basic.

(2) Formerly named SoMachine, EcoStruxure Machine Expert merges both former software ranges, SoMachine and SoMachine Motion.

Machine Automation

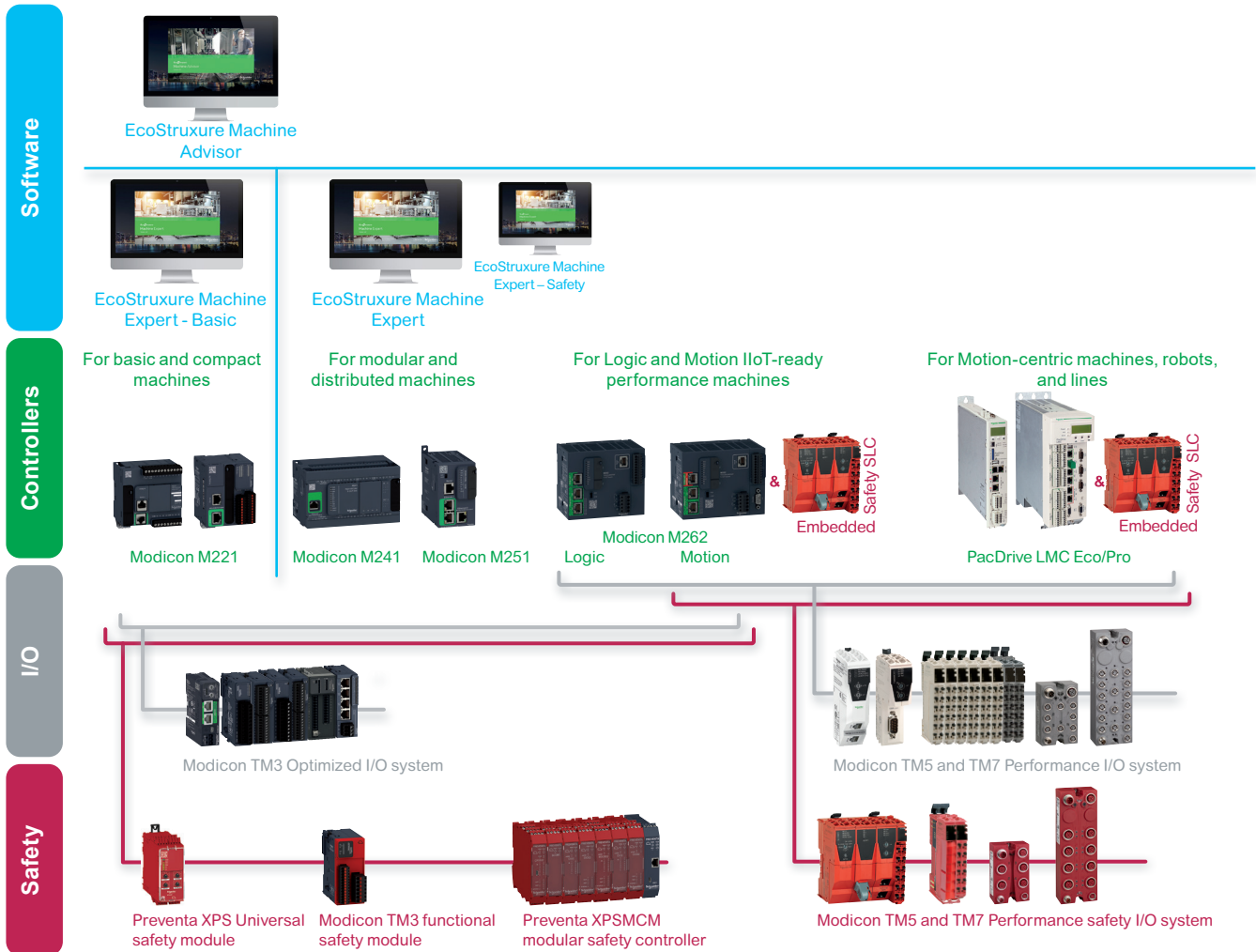

Machine control

> From basic to motion- and robot-centric machines with the PacDrive 3 offer, Modicon controllers and solutions bring a consistent and scalable response to achieving flexibility, performance, productivity, and digitization.

The scalability and consistency of I/O ranges allow you to select the right offer depending on your needs

> Modicon TM3 Optimized I/O system for more compact and modular machines
 > Modicon TM5 for more performance-demanding machines, with Modicon TM7 for harsh environments; Both Performance I/O ranges (Modicon TM5 and TM7) allow safety functions to be implemented using the Modicon TM5CSLC safety logic controller

Embedded Safety provides holistic solutions to Modicon M262 and PacDrive LMC controllers, increasing overall safety demand in Machine Automation

> Preventa XPS Universal safety modules cover a wide range of safety functions, suitable for small applications with 4-5 safety functions, with diagnostic information provided to controllers via a single wire connection
 > Modicon TM3 safety functional modules are suitable for small applications covering E-Stop functions and diagnostics via TM3 bus
 > Preventa XPSMCM modular safety controllers are suitable for medium size applications with up to 20 safety functions and diagnostics via Modbus TCP, EtherNet/IP, EtherCAT, or Profinet

All these devices are managed within a single software, EcoStruxure Machine Expert, a powerful and collaborative engineering environment

> **EcoStruxure Machine Expert – Safety** optional add-on for programming safety logic controllers
 > **EcoStruxure Machine Expert – Basic** software for programming Modicon M221 logic controllers: an intuitive standalone environment accessible to basic skilled technicians
 > **EcoStruxure Machine Advisor** is a cloud-based services platform designed for machine builders to track machines in operation worldwide, monitor performance data, and resolve exceptional events, while reducing support costs by up to 50%

Machine Automation

Comprehensive Schneider offers for machine builders

- > Lexium servo drives, motors, and robotics are designed to control applications ranging from a single independent axis up to high-performance synchronized multi-axis machines requiring high-speed and precise positioning and movements



- > The Lexium offer is designed for a broad range of motion-centric machines in applications such as [Packaging](#), [Material Handling](#), [Material Working](#), [Food and Beverage](#), and [Electronics](#)
- > Schneider Electric has developed Tested Validated & Documented Architectures (TVDA) applicable for generic machine control applications as well as for dedicated segment applications such as Packaging, Material Working, Material Handling, Hoisting, Pumping, or generic [Machine Control applications](#)

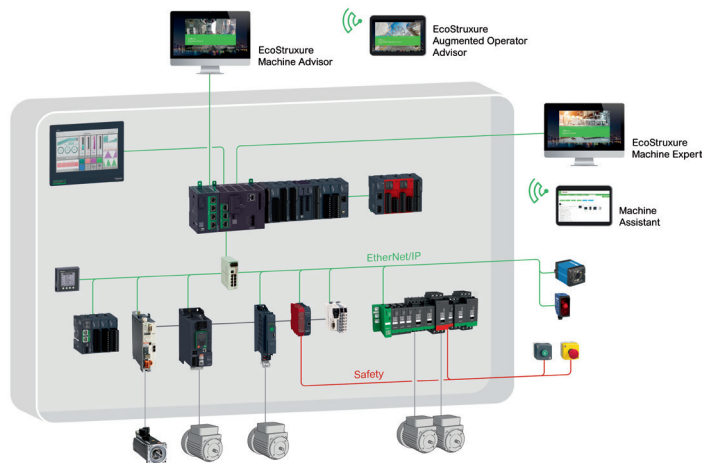

Choose Schneider Electric to help secure your investment and benefit from worldwide services at every step of your project

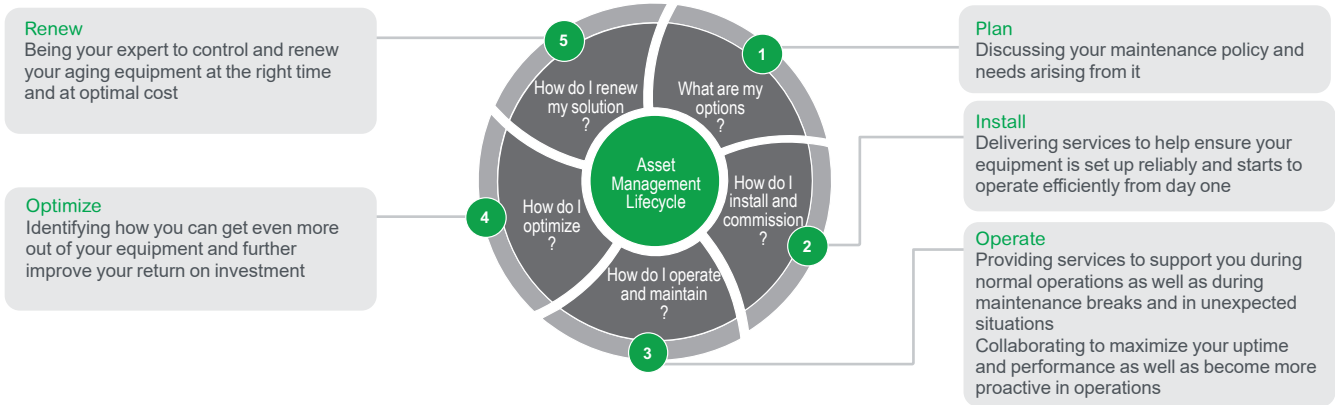

- > From planning and inception to modernization, we help ensure optimal technical and business performance. Our field service engineers combine 30+ years of manufacturer-level experience with the latest technology to bring innovation to every level of our offer, and every step of your project.
- > Our machine control dedicated services empower you to maximize your business infrastructure and face increasingly stringent demands on productivity, safety, equipment availability, and performance optimization.

Modicon TM7

High-Performance and Safe IP67 Distributed I/O System

Presentation of the range

Modicon TM7 range

The Modicon TM7 offer has been developed to create flexible, scalable I/O configurations for automation solutions based on Modicon and PacDrive controllers:

- Modicon M258 logic controllers
- Modicon LMC058 and LMC078 motion controllers
- PacDrive LMC Eco/Pro/Pro2 motion controllers
- Modicon M262 logic/motion controllers

The IP67 protection of these blocks enables them to be used within processes or machines in harsh environments (where there is a risk of splashing water, oil, dust, etc.) and offers the following advantages:

- ingress protection
- ruggedness and compactness
- rapid wiring, economical use

This I/O system is compatible with EcoStruxure Machine Expert software.

Digital blocks

The offer comprises input blocks, configurable I/O blocks, and an output block.

[See page 10](#)

Analog blocks

The offer comprises:

- expansion blocks with 4 inputs for connecting 4 sensors
- expansion blocks with 4 outputs for connecting 4 actuators
- expansion blocks with 2 inputs and 2 outputs
- expansion blocks with 4 resistive temperature probe or thermocouple temperature measurement channels

[See page 14](#)

Power distribution block

A power distribution block is available as an option to power I/O expansion blocks on the TM7 expansion bus.

This power distribution block is necessary to avoid voltage drops in the following situations:

- With a TM5SBET7 transmitter module (1) followed by 6 (2) TM7 I/O expansion blocks (mounted vertically)
- With a TM7NCOM08B CANopen interface block followed by 4 (2) TM7 I/O expansion blocks
- With a TM7NCOM16A/16B CANopen interface block followed by 18 (2) TM7 I/O expansion blocks

[See page 19](#)

Note: These limits must be weighted according to the cable lengths. Please refer to the SPIG (System Planning and Installation Guide) for the Modicon TM7 IP 67 block offer on our website www.schneider-electric.com

Safety blocks

The offer also comprises safety I/O blocks. These blocks complement the Modicon TM5 safety offer (1) on the Sercos bus.

[See page 19](#)

CANopen interface blocks with digital I/O

The CANopen interface block offer comprises IP67 blocks that connect to a CANopen bus and have digital channels that can be configured as inputs or outputs, including:

- A CANopen interface block with 8 configurable I/O for connection via M8 connector
- Two CANopen interface blocks with 16 configurable I/O

[See page 20](#)

Connection accessories

A range of cables and connectors is available for connecting the CAN bus, TM7 expansion bus, I/O, and the 24 V $\ddot{\text{c}}$ power supplies on TM7 expansion blocks.

[See page 26](#)

(1) Please refer to catalog ref. [DIA3ED2131204EN](#).

(2) Minimum number.



Digital I/O expansion block



Analog I/O expansion block



Power distribution block



Safety I/O blocks



CANopen interface blocks with digital I/O



[DIA3ED2131204EN](#)

Modicon TM7 expansion system

EcoStruxure Machine Expert software is used to configure the remote I/O and distributed I/O islands.

Remote I/O configuration

The TM5SBET7 bus expansion module (transmitter module) (1) is used to create remote I/O islands.

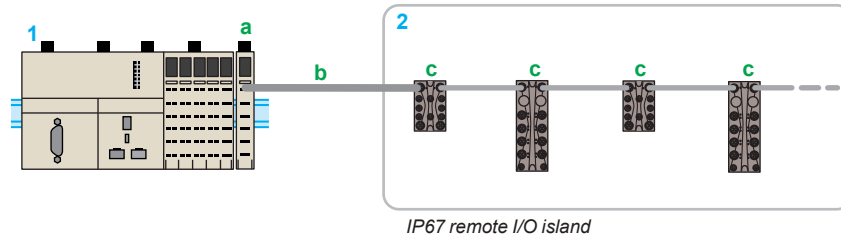

- 1 M258 logic controller/LMC058 motion controller + TM5SBET7 transmitter module (a) (1)
- 2 IP67 distributed I/O island: TM7 bus expansion cable (b) + TM7 digital/analog expansion blocks (c)

Distributed I/O configuration

Modicon TM7 CANOpen interface blocks are used to create distributed I/O islands on the CANopen bus. [See page 22](#)

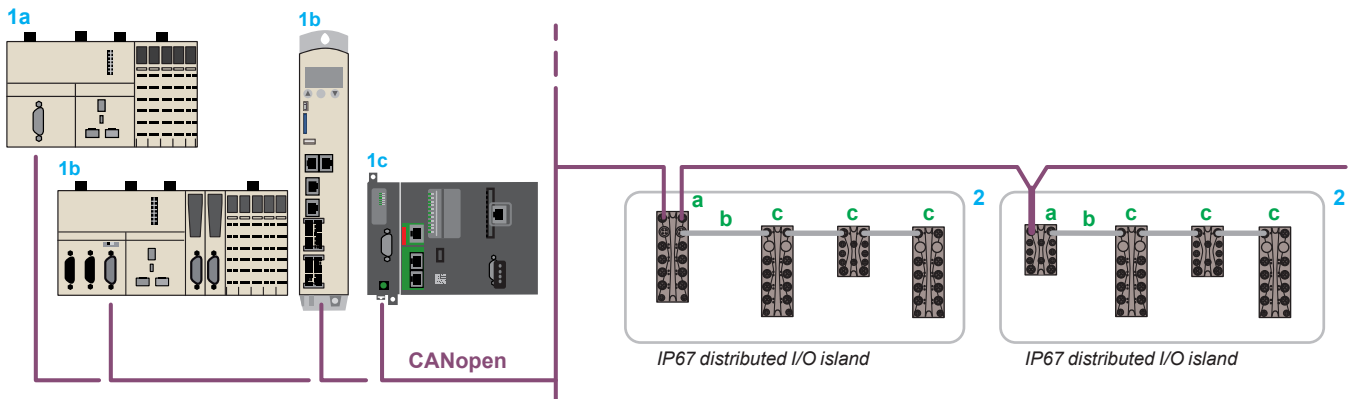

- 1 a Modicon M258 logic controller b Modicon LMC058 or Modicon LMC078 motion controller c TMSC01 communication module on Modicon M262 logic/motion controller: CANOpen bus masters
- 2 TM7 CANOpen interface block (slave) (a) + TM7 bus expansion cable (b) + TM7 digital/analog blocks (c)

(1) Modicon TM5 transmitter module: please refer to catalog ref. [DIA3ED2131204EN](#)

Diagnostic functions

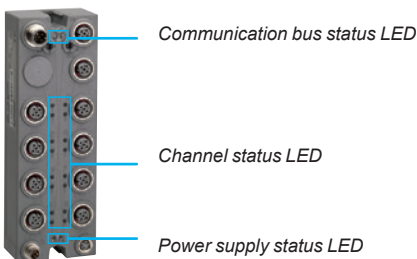

The diagnostics for monitoring detected faults are indicated by LEDs on the expansion blocks and power distribution blocks and inform the control system (Modicon M258 logic controller or Modicon LMC058 motion controller) via the TM7 bus.

Each Modicon TM7 block has LEDs for:

- displaying the status of the TM7 bus, channels, and power supply
- quick, precise location of a detected fault

There are several levels of diagnostics:

- Channel diagnostics: state of inputs and outputs
- Expansion block diagnostics:
 - Presence of sensor/actuator power supply
 - Undervoltage fault detected on the I/O power supply
 - Analog input diagnostics
 - Short-circuit or overload on one or more digital outputs
- Communication bus diagnostics:
 - On CAN bus (CANOpen interface block)
 - On TM7 expansion bus (CANOpen interface block and I/O expansion blocks)
- Power supply diagnostics via the TM7 bus (expansion block only)

Modicon TM7

High-Performance and Safe IP67 Distributed I/O System
Digital I/O blocks

Applications	
Compatibility	Remote I/O
	Distributed I/O

Digital I/O expansion blocks	
With TM5SBET7 bus expansion module (transmitter module):	
<ul style="list-style-type: none"> - Modicon M258 logic controller - Modicon LMC058 motion controller 	
■ With TM7NCOM... CANopen interface block:	
<ul style="list-style-type: none"> - Modicon M258 logic controller - Modicon LMC058 motion controller - Modicon LMC078 motion controller - Modicon M262 logic/motion controller 	
■ With Modicon TM5 network interface modules over Ethernet, Sercos and CANopen	



Degree of protection		IP67	IP67	IP67	
Housing type		Plastic	Plastic	Plastic	
Modularity (number of channels)	Max. number of digital channels	8	16	16	
	Digital inputs	8	16	16	
	Digital outputs	-	-	-	
Digital inputs	Voltage/Current	24 V ---/7 mA	24 V ---/7 mA	24 V ---/7 mA	
	Type	Sink (1)	Sink (1)	Sink (1)	
	IEC 61131-2 conformity	Type 1	Type 1	Type 1	
Digital outputs	Voltage	-	-	-	
	Type	-	-	-	
	Current per output	-	-	-	
	Current per expansion block	-	-	-	
Sensor/actuator power supply	Voltage	24 V ---	24 V ---	24 V ---	
	Max. current	500 mA for all channels	500 mA for all channels	500 mA for all channels	
	Protection against	Overloads, short-circuits, and reverse polarity	Overloads, short-circuits, and reverse polarity	Overloads, short-circuits, and reverse polarity	
Connection	TM7 expansion bus	Bus input connector	B-coded 4-way male M12	B-coded 4-way male M12	B-coded 4-way male M12
		Bus output connector	B-coded 4-way female M12	B-coded 4-way female M12	B-coded 4-way female M12
	Digital I/O channels	Sensor connector	3-way female M8, 1 channel per connector	3-way female M8, 1 channel per connector	A-coded 5-way female M12, 2 channels per connector
		Actuator connector	-	-	-
	Expansion block power supply	Input connector	4-way male M8	4-way male M8	4-way male M8
		Output connector	4-way female M8	4-way female M8	4-way female M8
Diagnostics	By expansion block	Yes	Yes	Yes	
	By channel	Yes	Yes	Yes	
	By communication on TM7 bus	Yes	Yes	Yes	
Expansion block		TM7BDI8B	TM7BDI16B	TM7BDI16A	

Degree of protection		IP67	IP67	IP67	IP67	
Housing type		Plastic	Plastic	Plastic	Plastic	
Modularity (number of channels)	Max. number of digital channels	8	8	16	16	
	Digital inputs	-	0...8 software-configurable	0...16 software-configurable	0...16 software-configurable	
	Digital outputs	8	0...8 software-configurable	0...16 software-configurable	0...16 software-configurable	
Digital inputs	Voltage/Current	-	24 V ---/4.4 mA	24 V ---/4.4 mA	24 V ---/4.4 A max.	
	Type	-	Sink (1)	Sink (1)	Sink (1)	
	IEC 61131-2 conformity	-	Type 1	Type 1	Type 1	
Digital outputs	Voltage	24 V ---	24 V ---	24 V ---	24 V ---	
	Type	Transistor/Source (2)	Transistor/Source (2)	Transistor/Source (2)	Transistor/Source (2)	
	Current per output	2 A max.	0.5 A max.	0.5 A max.	0.5 A max.	
	Current per expansion block	8 A max.	4 A max.	8 A max.	8 A max.	
Sensor/actuator power supply	Voltage	24 V ---	24 V ---	24 V ---	24 V ---	
	Max. current	500 mA for all channels	500 mA for all channels	500 mA for all channels	500 mA for all channels	
	Protection against	Overloads, short-circuits, and reverse polarity	Overloads, short-circuits, and reverse polarity	Overloads, short-circuits, and reverse polarity	Overloads, short-circuits, and reverse polarity	
Connection	TM7 expansion bus	Bus input connector	B-coded 4-way male M12	B-coded 4-way male M12	B-coded 4-way male M12	
		Bus output connector	B-coded 4-way female M12	B-coded 4-way female M12	B-coded 4-way female M12	
	Digital I/O channels	Sensor connector	-	3-way female M8, 1 channel per connector	A-coded 5-way female M12, 2 channels per connector	3-way female M8, 1 channel per connector
		Actuator connector	3-way female M8, 1 channel per connector	3-way female M8, 1 channel per connector	5-way female M12, 2 channels per connector	3-way female M8, 1 channel per connector
	Expansion block power supply	Input connector	4-way male M8	4-way male M8	4-way male M8	4-way male M8
		Output connector	4-way female M8	4-way female M8	4-way female M8	4-way female M8
Diagnostics	By expansion block	Yes	Yes	Yes	Yes	
	By channel	Yes	Yes	Yes	Yes	
	By communication on TM7 bus	Yes	Yes	Yes	Yes	
Expansion block		TM7BDO8TAB	TM7BDM8B	TM7BDM16A	TM7BDM16B	

Modicon TM7

High-Performance and Safe IP67 Distributed I/O System

Digital I/O blocks

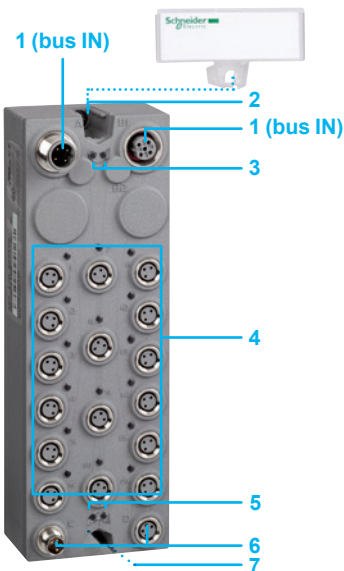
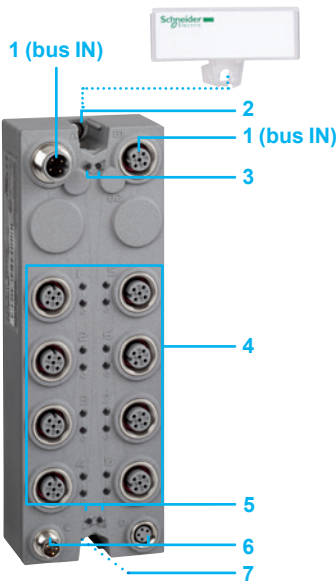
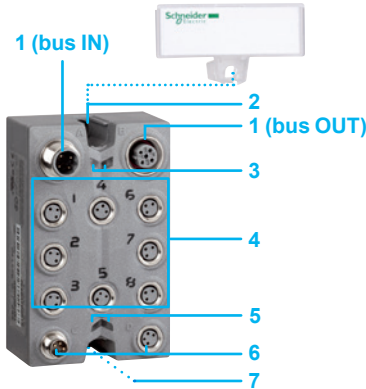

Description

Digital I/O expansion blocks

8-channel digital I/O expansion blocks have the following on the front panel:

- 1 A male M12 connector (bus IN) and a female M12 connector (bus OUT) for connecting the TM7 expansion bus
- 2 A slot for the expansion block label (1)
- 3 Two bus diagnostic LEDs
- 4 Eight female M8 connectors for connecting sensors and actuators with channel status LEDs
- 5 Two LEDs indicating the status of the 24 V $\bar{\text{---}}$ sensor and actuator power supplies
- 6 Two M8 connectors for connecting the 24 V $\bar{\text{---}}$ sensor and actuator power supplies (male for PWR IN, female for PWR OUT)
- 7 Mounting using two \varnothing 4 screws (not supplied) and connection of the functional ground when block is mounted on a metal support

16-channel digital I/O expansion blocks have the following on the front panel:

- 1 A male M12 connector (bus IN) and a female M12 connector (bus OUT) for connecting the TM7 expansion bus
- 2 A slot for the expansion block label (1)
- 3 Two bus diagnostic LEDs
- 4 Eight M12 connectors (2 channels per connector) or sixteen M8 connectors for connecting sensors and actuators with channel status LEDs
- 5 Two LEDs indicating the status of the 24 V $\bar{\text{---}}$ sensor and actuator power supplies
- 6 Two M8 connectors for connecting the 24 V $\bar{\text{---}}$ sensor and actuator power supplies (male for PWR IN, female for PWR OUT)
- 7 Mounting using two \varnothing 4 screws (not supplied) and connection of the functional ground when block is mounted on a metal support

(1) Label-holder supplied with IP67 block



TM7BDI8B,
TM7BDO8TAB,
TM7BDM8B



TM7BDM16B,
TM7BDI16B



TM7BDI16A,
TM7BDM16A

Digital I/O expansion blocks						
Max. no. of channels	Number/type of inputs (1)	Number/type of outputs (2)	Sensor and actuator connection	Communication bus	Reference	Weight kg/lb
8, input	8, sink (3)	–	8 female M8 connectors	TM7 bus	TM7BDI8B	0.180/ 0.397
16, input	16, sink (3)	–	16 female M8 connectors	TM7 bus	TM7BDI16B	0.320/ 0.705
	16, sink (3)	–	8 female M12 connectors	TM7 bus	TM7BDI16A	0.320/ 0.705
8, output	–	8, transistor/source (4), 2 A max.	8 female M8 connectors	TM7 bus	TM7BDO8TAB	0.185/ 0.408
8, I/O, configurable	0...8, sink (3)	0...8, transistor/source (4), 0.5 A max.	8 female M8 connectors	TM7 bus	TM7BDM8B	0.190/ 0.419
16, I/O, configurable	0...16, sink (3)	0...16, transistor/source (4), 0.5 A max.	8 female M12 connectors	TM7 bus	TM7BDM16A	0.320/ 0.705
			16 female M8 connectors	TM7 bus	TM7BDM16B	0.320/ 0.705

(1) 24 V \pm IEC type 1

(2) 24 V \pm

(3) Sink inputs: positive logic

(4) Source outputs: positive logic

Architecture and connection cables

[See page 26](#)

Separate parts

[See page 29](#)

Configuration software

■ EcoStruxure Machine Expert software: please refer to catalog Ref. [DIA3ED2180701EN](#)

Modicon TM7

High-Performance and Safe IP67 Distributed I/O System

Analog I/O blocks

Applications		Analog I/O expansion blocks
Compatibility	Local and remote I/O	With TM5SBET7 bus expansion module (transmitter module):
	Distributed I/O	- Modicon M258 logic controller - Modicon LMC058 motion controller
		■ With TM7NCOM●●● CANopen interface block:
		- Modicon M258 logic controller - Modicon LMC058 motion controller - Modicon LMC078 motion controller - Modicon M262 logic/motion controller
		■ With Modicon TM5 network interface modules over Ethernet, Sercos and CANopen



Degree of protection	IP67	IP67	IP67		
Housing type	Plastic	Plastic	Plastic		
Modularity (number of channels)	Max. number of analog channels	4	4		
	Analog inputs	4	4		
	Temperature inputs	-	-		
	Analog outputs	-	4		
Inputs	Type	Voltage -10...+10 V $\overline{\text{---}}$	Current 0...20 mA		
	Resolution	11 bits + sign	12 bits		
Analog outputs	Type	-	-		
	Resolution	-	-		
	Current per expansion block	-	-		
Sensor/actuator power supply	Voltage	24 V $\overline{\text{---}}$	24 V $\overline{\text{---}}$		
	Max. current	500 mA for all channels	500 mA for all channels		
	Protection against	Overloads, short-circuits, and reverse polarity	Overloads, short-circuits, and reverse polarity		
Connection	TM7 expansion bus	Bus input connector	B-coded 4-way male M12	B-coded 4-way male M12	B-coded 4-way male M12
		Bus output connector	B-coded 4-way female M12	B-coded 4-way female M12	B-coded 4-way female M12
		Analog I/O channels	A-coded 5-way female M12	A-coded 5-way female M12	A-coded 5-way female M12
	Expansion block power supply	Input connector	4-way male M8	4-way male M8	4-way male M8
		Output connector	4-way female M8	4-way female M8	4-way female M8
		Actuator connector	-	-	-
	Diagnostics	By expansion block	Yes	Yes	Yes
		By channel	Yes	Yes	Yes
By communication on TM7 bus		Yes	Yes	Yes	
Expansion block	TM7BAI4VLA	TM7BAI4CLA	TM7BAI4TLA		
Page	16				

IP67	IP67	IP67	IP67	IP67
Plastic	Plastic	Plastic	Plastic	Plastic
4	4	4	4	4
-	-	-	2	2
4	-	-	-	-
-	4	4	2	2
J, K, S thermocouple Voltage 0...65,536 μV	-	-	Voltage -10...+10 V $\overline{\text{---}}$	Current 0...20 mA
16 bits	-	-	11 bits + sign	12 bits
-	Voltage -10...+10 V $\overline{\text{---}}$	Current 0...20 mA	Voltage -10...+10 V $\overline{\text{---}}$	Current 0...20 mA
-	11 bits + sign	12 bits	11 bits + sign	12 bits
-	-	-	-	-
-	24 V $\overline{\text{---}}$	24 V $\overline{\text{---}}$	24 V $\overline{\text{---}}$	24 V $\overline{\text{---}}$
-	500 mA for all channels	500 mA for all channels	500 mA for all channels	500 mA for all channels
-	Overloads, short-circuits, and reverse polarity	Overloads, short-circuits, and reverse polarity	Overloads, short-circuits, and reverse polarity	Overloads, short-circuits, and reverse polarity
B-coded 4-way male M12	B-coded 4-way male M12	B-coded 4-way male M12	B-coded 4-way male M12	B-coded 4-way male M12
B-coded 4-way female M12	B-coded 4-way female M12	B-coded 4-way female M12	B-coded 4-way female M12	B-coded 4-way female M12
A-coded 5-way female M12	-	-	A-coded 5-way female M12	A-coded 5-way female M12
-	A-coded 5-way female M12	A-coded 5-way female M12	A-coded 5-way female M12	A-coded 5-way female M12
4-way male M8	4-way male M8	4-way male M8	4-way male M8	4-way male M8
4-way female M8	4-way female M8	4-way female M8	4-way female M8	4-way female M8
Yes	Yes	Yes	Yes	Yes
Yes	Yes	Yes	Yes	Yes
Yes	Yes	Yes	Yes	Yes
TM7BAI4PLA	TM7BAO4VLA	TM7BAO4CLA	TM7BAM4VLA	TM7BAM4CLA
16	16			

Modicon TM7

High-Performance and Safe IP67 Distributed I/O System

Analog I/O blocks

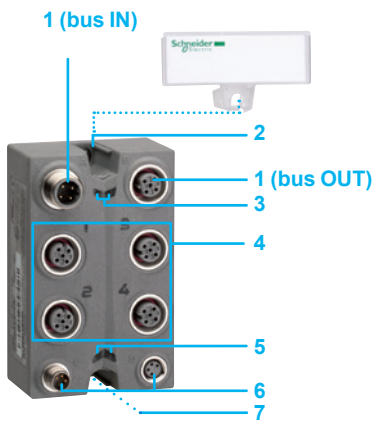

Description

Analog I/O expansion blocks

Analog I/O expansion blocks have the following on the front panel:

- 1 A male M12 connector (bus IN) and a female M12 connector (bus OUT) for connecting the TM7 expansion bus
- 2 A slot for the expansion block label (1)
- 3 Two bus diagnostic LEDs
- 4 Four female M12 connectors for connecting sensors and/or actuators with channel status LEDs
- 5 Two LEDs indicating the status of the 24 V $\overline{\text{---}}$ sensor and actuator power supplies
- 6 Two M8 connectors for connecting the 24 V $\overline{\text{---}}$ sensor and actuator power supplies (male for PWR IN, female for PWR OUT)
- 7 Mounting using two $\varnothing 4$ screws (not supplied) and connection of the functional ground when block is mounted on a metal support

(1) Label-holder supplied with IP67 block

Modicon TM7

High-Performance and Safe IP67 Distributed I/O System

Analog I/O blocks



TM7BAI4●LA,
TM7BAO4●LA,
TM7BAM4●LA

Analog I/O expansion blocks

Max. no. of channels	Input range	Output range	Resolution	Sensor and actuator connection	Communication bus	Reference	Weight kg/lb
4 input	Voltage -10...+10 V $\overline{\text{---}}$	–	11 bits + sign	4 female M12 connectors	TM7 bus	TM7BAI4VLA	0.200/ 0.441
	Current 0...20 mA	–	12 bits	4 female M12 connectors	TM7 bus	TM7BAI4CLA	0.200/ 0.441
	Pt 100, Pt 1000 temperature probe KTY 10, KTY 84 silicon temperature probe Resistance 0...3,276 Ω	–	16 bits	4 female M12 connectors	TM7 bus	TM7BAI4TLA	0.200/ 0.441
	J, K, S thermocouple Voltage 0...65,536 μV	–	16 bits	4 female M12 connectors	TM7 bus	TM7BAI4PLA	0.200/ 0.441
4 output	–	Voltage -10...+10 V $\overline{\text{---}}$	11 bits + sign	4 female M12 connectors	TM7 bus	TM7BAO4VLA	0.200/ 0.441
	–	Current 0...20 mA	12 bits	4 female M12 connectors	TM7 bus	TM7BAO4CLA	0.200/ 0.441
2 input + 2 output	Voltage -10...+10 V $\overline{\text{---}}$	Voltage -10...+10 V $\overline{\text{---}}$	11 bits + sign	4 female M12 connectors	TM7 bus	TM7BAM4VLA	0.200/ 0.441
	Current 0...20 mA	Current 0...20 mA	12 bits	4 female M12 connectors	TM7 bus	TM7BAM4CLA	0.200/ 0.441

Architecture and connection cables

[See page 26](#)

Separate parts

[See page 29](#)

Configuration software

■ EcoStruxure Machine Expert software: please refer to catalog Ref. [DIA3ED2180701EN](#)

Modicon TM7

High-Performance and Safe IP67 Distributed I/O System

Power distribution block

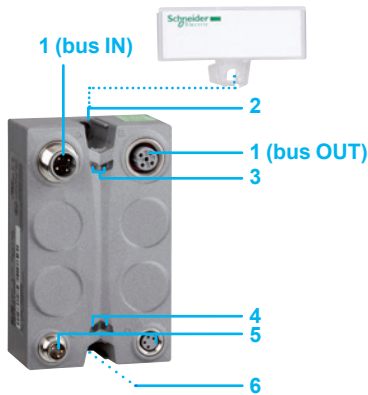

TM7SPS1A

Description

Power distribution block

The power distribution blocks have the following on the front panel:

- 1 A male M12 connector (bus IN) and a female M12 connector (bus OUT) for connecting the TM7 expansion bus
- 2 A slot for the power distribution block label (1)
- 3 Two TM7 bus diagnostic LEDs
- 4 Two LEDs indicating the status of the 24 V $\bar{\text{c}}$ sensor and actuator power supplies
- 5 Two M8 connectors for connecting the 24 V $\bar{\text{c}}$ sensor and actuator power supplies (male for PWR IN, female for PWR OUT)
- 6 Mounting using two \varnothing 4 screws (not supplied) and connection of the functional ground when block is mounted on a metal support

Power distribution block compatibility

	TM7SPS1A
Local and remote I/O	With TM5SBET7 bus expansion module (transmitter module): <ul style="list-style-type: none"> - Modicon M258 logic controller - Modicon LMC058 motion controller
Distributed I/O	With TM7NCOM●●● CANopen interface block: <ul style="list-style-type: none"> - Modicon M258 logic controller - Modicon LMC058 motion controller - Modicon LMC078 motion controller - Modicon M262 logic/motion controller

(1) Label-holder supplied with power distribution block

References

Function	Connection	Communication bus	Reference	Weight kg/lb
24 V $\bar{\text{c}}$ /15 W power supply for I/O expansion blocks on the TM7 expansion bus	Power supply: 2x M8 connectors, TM7 bus		TM7SPS1A	0.190/ 0.419
	TM7 bus: 2x M12 connectors, 1 male and 1 female			

Architecture and connection cables

See page 24 to 29

Separate parts

See page 29

Configuration software

- EcoStruxure Machine Expert software: please refer to catalog Ref. [DIA3ED2180701EN](#)

Presentation
Safety I/O blocks

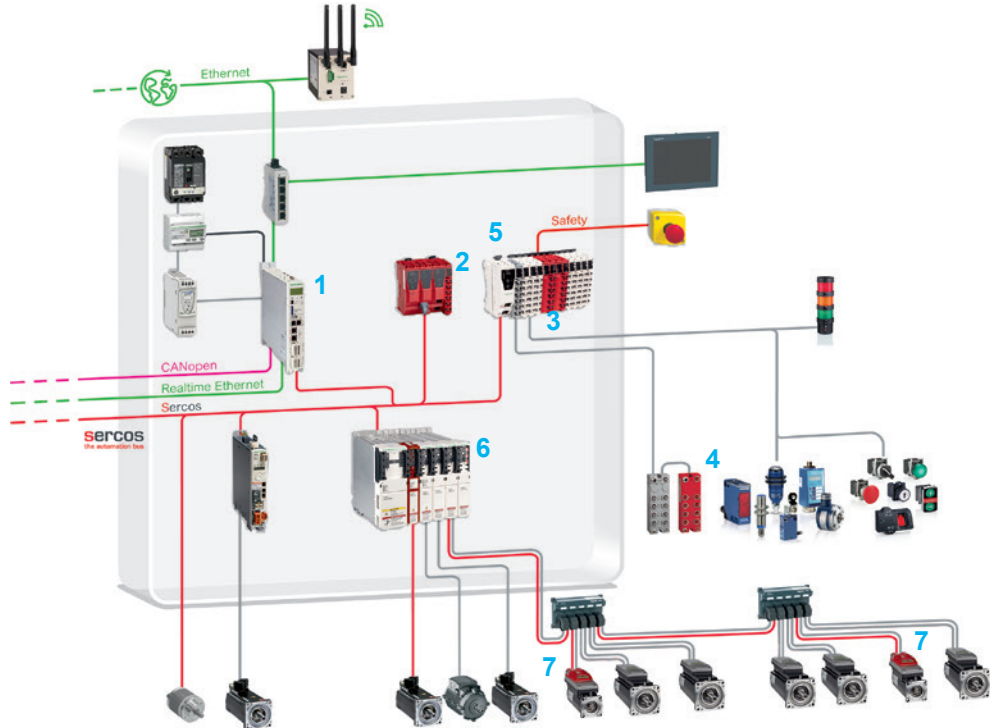

- 1 PacDrive LMC motion controller or Modicon M262 logic/motion controller (1)
 - 2 Modicon TM5CSLC safety logic controller, Sercos slave interface
 - 3 Modicon TM5 safety I/O modules
 - 4 Modicon TM7 safety I/O blocks
 - 5 Modicon TM5 Sercos interface modules
 - 6 Lexium 62 safety servo drives (2) or Lexium 62 ILM integrated servo drive with optional safety module (3)
- (1) Refer to catalog ref. [DIA3ED2180503EN](#).
 (2) Refer to catalog ref. [DIA7ED2160305EN](#).
 (3) Refer to catalog ref. [DIA7ED2160306EN](#).



[DIA3ED2180503EN](#)



[DIA7ED2160305EN](#)



[DIA7ED2160306EN](#)

Safety I/O blocks compatibility

	TM7SDI8DFS, TM7SDM12DTFS
Local and remote I/O	–
Distributed I/O	With TM5 Sercos interface block - PacDrive LMC Eco/Pro/Pro2 motion controllers - Modicon M262 logic/motion controller

Modicon TM7 safety I/O blocks are IP67 I/O dedicated to safety-related applications.

Two versions are available:

- One with 8 safety digital (sink) inputs and 2 non-safety digital inputs
- One with 8 safety digital (sink) inputs and 4 safety digital outputs

Modicon TM7 safety I/O expansion blocks use a power bus and a data bus to operate:

- The TM7 power bus distributes power to supply the electronic components of the TM7 safety I/O blocks. It is powered by the Modicon TM5SBET7 transmitter module.
- The TM7 data bus transmits data between the Sercos bus interface and the TM7 expansion modules.



TM7SDI8DFS



TM7SDM12DTFS

References

Designation	Description	Reference	Weight kg/lb
IP67 safety input block	8 safety digital inputs, 24 V DC, sink 2 digital inputs	TM7SDI8DFS	0.217/ 0.478
IP67 safety I/O block	8 safety digital inputs, 24 VDC, sink 4 safety digital outputs, 24 VDC, transistor	TM7SDM12DTFS	0.320/ 0.705

Separate parts

[See page 29](#)

Modicon TM7

High-Performance and Safe IP67 Distributed I/O System

CANopen interface blocks

Applications	
Compatibility	Local and remote I/O
	Distributed I/O

CANopen bus interface with digital I/O
- Modicon M258 logic controller - Modicon LMC058 motion controller
- Modicon M258 logic controller - Modicon LMC058 motion controller - Modicon LMC078 motion controller - Modicon M262 logic/motion controller - PacDrive LMC Eco/Pro/Pro2 motion controllers



Degree of protection	IP67	
Housing type	Plastic	
Modularity (number of channels)	Max. number of digital channels	8 channels configurable as inputs or outputs
	Digital inputs	0...8 according to software configuration
	Digital outputs	0...8 according to software configuration
Digital inputs	Voltage/Current	24 V \pm /4.4 mA
	Type	Sink (1)
	IEC 61131-2 conformity	Type 1
Digital outputs	Voltage	24 V \pm
	Type	Transistor/Source (2)
	Current per output	0.5 A max.
	Current per interface block	4 A max.
Sensor/actuator power supply	Voltage	24 V \pm
	Max. current	500 mA for all channels
	Protection against	Overloads, short-circuits, and reverse polarity
Connection	CANopen bus	Bus input connector
		Bus output connector
	TM7 expansion bus	Bus input connector
		Bus output connector
	Digital I/O channels	Sensor connector
		Actuator connector
	Interface block power supply	Input connector
		Output connector
Diagnostics	By interface block	Yes
	By channel	Yes
	By communication	Yes
	On CANopen bus	Yes
	On TM7 bus	Yes
CANopen interface block	TM7NCOM08B	
Page	23	

	IP67	IP67
	Plastic	Plastic
	8 channels configurable as inputs or outputs	16 channels configurable as inputs or outputs
	0...8 according to software configuration	0...16 according to software configuration
	0...8 according to software configuration	0...16 according to software configuration
	24 V \pm /4.4 mA	24 V \pm /4.4 mA
	Sink (1)	Sink (1)
	Type 1	Type 1
	24 V \pm	24 V \pm
	Transistor/Source (2)	Transistor/Source (2)
	0.5 A max.	0.5 A max.
	4 A max.	4 A max.
	24 V \pm	24 V \pm
	500 mA for all channels	500 mA for all channels
	Overloads, short-circuits, and reverse polarity	Overloads, short-circuits, and reverse polarity
	A-coded 5-way male M12	A-coded 5-way male M12
	-	A-coded 5-way female M12
	-	-
	B-coded 4-way female M12	B-coded 4-way female M12
	3-way female M8, 1 channel per connector	3-way female M8, 1 channel per connector
	3-way female M8, 1 channel per connector	3-way female M8, 1 channel per connector
	4-way male M8	4-way male M8
	4-way female M8	4-way female M8
	Yes	Yes
	Yes	Yes
	Yes	Yes
	Yes	Yes
	TM7NCOM08B	TM7NCOM16B
	23	23

(1) Sink inputs: positive logic
(2) Source outputs: positive logic

	IP67
	Plastic
	16 channels configurable as inputs or outputs
	0...16 according to software configuration
	0...16 according to software configuration
	24 V \pm /4.4 mA
	Sink (1)
	Type 1
	24 V \pm
	Transistor/Source (2)
	0.5 A max.
	4 A max.
	24 V \pm
	500 mA for all channels
	Overloads, short-circuits, and reverse polarity
	A-coded 5-way male M12
	A-coded 5-way female M12
	-
	B-coded 4-way female M12
	A-coded 5-way female M12, 2 channels per connector
	A-coded 5-way female M12, 2 channels per connector
	4-way male M8
	4-way female M8
	Yes
	Yes
	Yes
	Yes
	TM7NCOM16A
	23

Modicon TM7

High-Performance and Safe IP67 Distributed I/O System

CANopen interface blocks

Presentation



The Modicon TM7 CANopen interface blocks enable sensors and actuators distributed over machines to be connected via the CANopen fieldbus. These interface blocks communicate on the bus. They have one part for connecting sensors and actuators using M8 or M12 connectors and one part for connections to the CANopen fieldbus.

IP67 protection means that these blocks can be used within processes or machines in harsh environments (where there is a risk of splashing water, oil, or dust, etc.).

They have the following characteristics:

- Ingress protection
- Ruggedness and compactness
- Rapid wiring, economical use

The offer comprises:

- A CANopen interface block with 8 configurable I/O for connection via M8 connector
- Two Modicon TM7 CANopen interface blocks with 16 configurable I/O

The following components complete the offer:

- digital I/O expansion blocks
- analog input expansion blocks
- power distribution block
- connection accessories

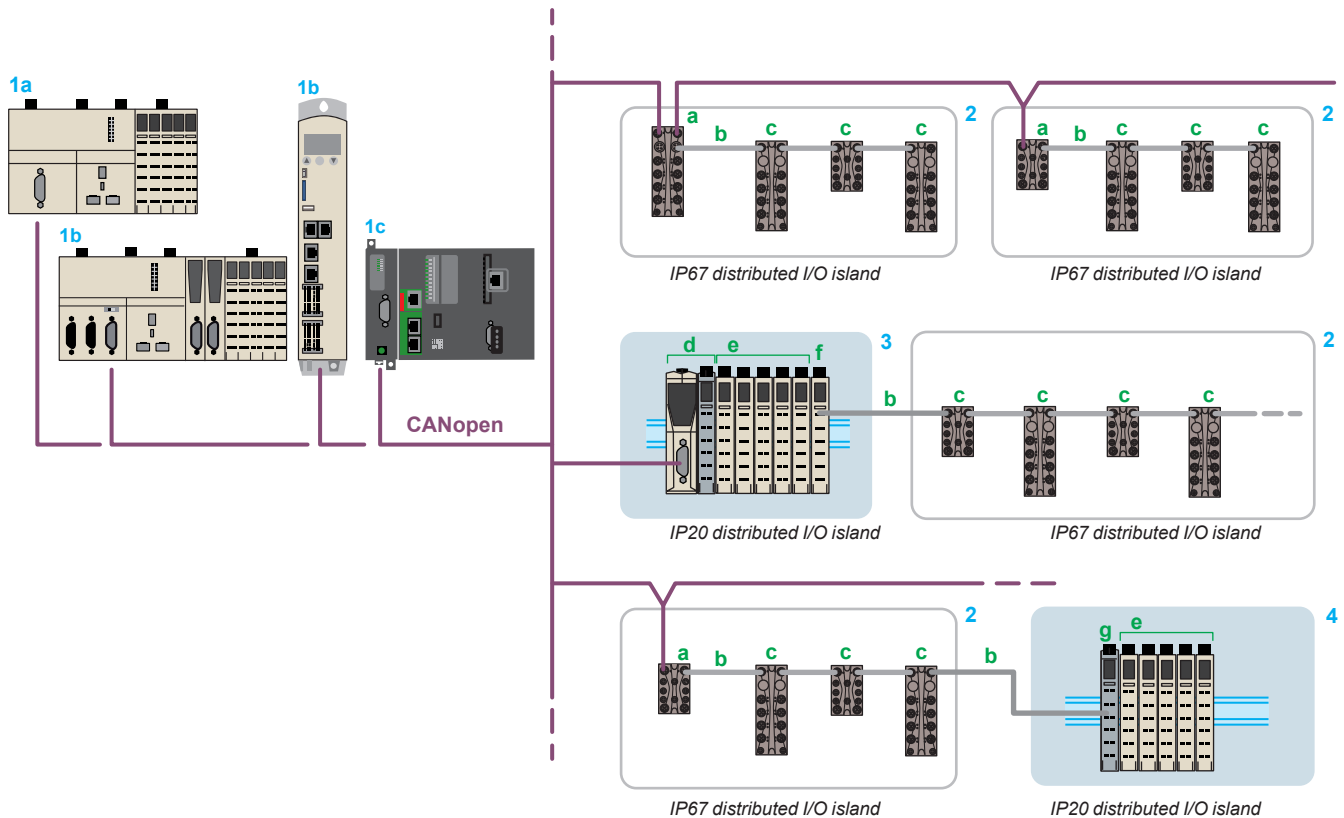

1 a Modicon M258 logic controller b Modicon LMC058 or Modicon LMC078 motion controller c TMSCO1 communication module on Modicon M262 logic/motion controller: CANopen bus masters

2 TM7 CANopen interface block (slave) with digital I/O (a) + TM7 bus expansion cable (b) + TM7 digital/analog blocks (c) (1)

3 TM5 CANopen interface module (slave) (d) + TM5 modules (e) (2) + TM5SBET7 transmitter module (f) (2)

4 TM5SBER2 receiver module (g) (2) + TM5 modules (e) (2)

(1) Modicon TM7 digital/analog blocks, [see page 18](#)

(2) Modicon TM5: please refer to catalog ref. [DIA3ED2131204EN](#)

Modicon TM7

High-Performance and Safe IP67 Distributed I/O System

CANopen interface blocks

Diagnostic functions

The diagnostics for monitoring detected faults are indicated by LEDs on the Modicon TM7 CANopen interface blocks and inform the control system (Modicon M258 logic controller or Modicon LMC058 motion controller) via the TM7 bus.

Each Modicon TM7 interface block has LEDs for:

- displaying the status of the TM7 bus, channels, and power supply
- quick, precise location of a detected fault

Diagnostics are performed at the following levels:

- Channel diagnostics:

- State of inputs
- State of outputs

- Communication bus diagnostics:

- On CAN bus (CANopen interface block)
- On TM7 expansion bus (CANopen interface block and I/O expansion blocks)

Modicon TM7

High-Performance and Safe IP67 Distributed I/O System

CANopen interface blocks

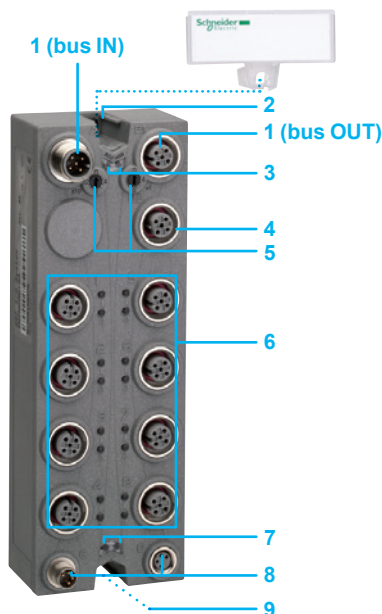
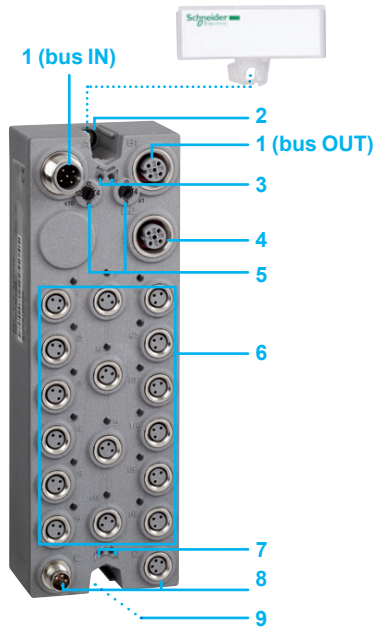
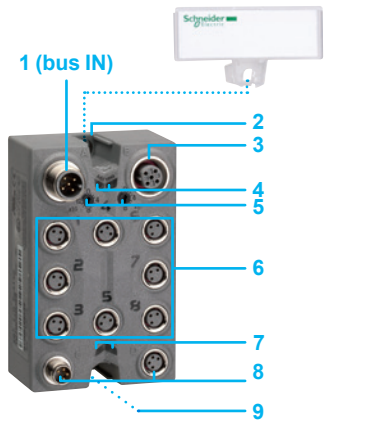

Description

Modicon TM7 CANopen interface blocks

Modicon TM7 **8-channel** CANopen interface blocks have the following on the front panel:

- 1 A male M12 connector (bus IN) for connecting the CANopen bus
- 2 A slot for the interface block label (1)
- 3 A female M12 connector for connecting the TM7 expansion bus
- 4 Two bus diagnostic LEDs
- 5 Thumbwheels for addressing on CANopen bus
- 6 Eight female M8 connectors for connecting sensors and actuators with eight channel status LEDs
- 7 Two LEDs indicating the status of the 24 V $\bar{\text{---}}$ sensor and actuator power supplies
- 8 Two M8 connectors for connecting the 24 V $\bar{\text{---}}$ sensor and actuator power supplies (male for PWR IN, female for PWR OUT)
- 9 Mounting using two \varnothing 4 screws (not supplied) and connection of the functional ground when block is mounted on a metal support

Modicon TM7 **16-channel** CANopen interface blocks have the following on the front panel:

- 1 A male M12 connector (bus IN) and a female M12 connector (bus OUT) for connecting the CANopen bus
- 2 A slot for the interface block label (1)
- 3 Two bus diagnostic LEDs
- 4 A female M12 connector for connecting the TM7 expansion bus
- 5 Thumbwheels for addressing on CANopen bus
- 6 Eight M12 connectors (2 channels per connector) or sixteen M8 connectors for connecting sensors and actuators with channel status LEDs
- 7 Two LEDs indicating the status of the 24 V $\bar{\text{---}}$ sensor and actuator power supplies
- 8 Two M8 connectors for connecting the 24 V $\bar{\text{---}}$ sensor and actuator power supplies (male for PWR IN, female for PWR OUT)
- 9 Mounting using two \varnothing 4 screws (not supplied) and connection of the functional ground when block is mounted on a metal support

(1) Label-holder supplied with IP67 block

Modicon TM7

High-Performance and Safe IP67 Distributed I/O System

CANopen interface blocks



TM7NCOM08B

Modicon TM7 CANopen interface blocks with digital I/O

Max. no. of channels	Number/type of inputs	Number/type of outputs	Sensor and actuator connection	Communication bus	Reference	Weight kg/lb
8 I/O	8, sink (1)	8, transistor/source (2)	8 female M8 connectors	CANopen, TM7 bus	TM7NCOM08B	0.195/ 0.430
16 I/O	16, sink (1)	16, transistor/source (2)	16 female M8 connectors	CANopen, TM7 bus	TM7NCOM16B	0.320/ 0.705
	16, sink (1)	16, transistor/source (2)	8 female M12 connectors	CANopen, TM7 bus	TM7NCOM16A	0.320/ 0.705



TM7NCOM16B



TM7NCOM16A

(1) Sink inputs: positive logic
 (2) Source outputs: positive logic

Architecture and connection cables

[See page 26](#)

Separate parts

[See page 29](#)

Configuration software

- EcoStruxure Machine Expert software: please refer to catalog ref. [DIA3ED2180701EN](#)
- Performance distributed I/O configuration software: please visit our website www.schneider-electric.com

Modicon TM7

High-Performance and Safe IP67 Distributed I/O System

Connection components: CANopen and TM7 bus architecture

CANopen architecture

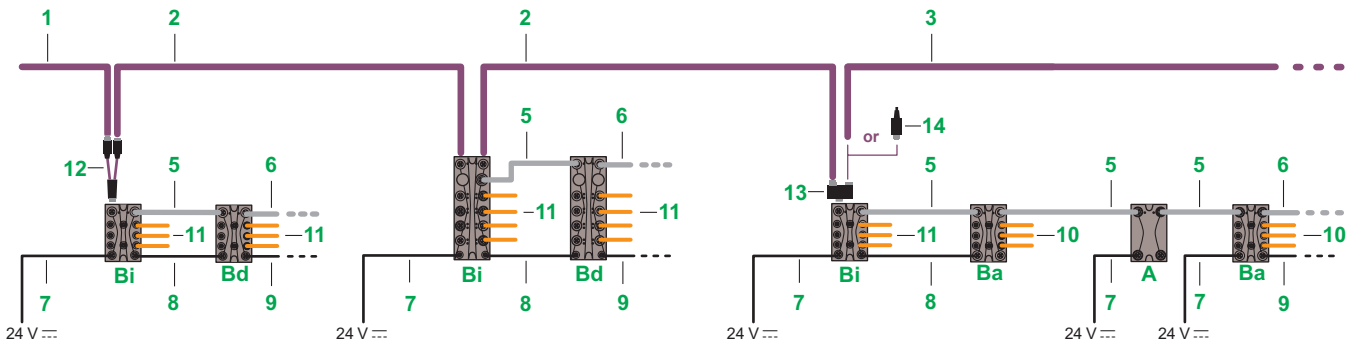

TM7 bus architecture

TM5NCO1 + TM5SBET7

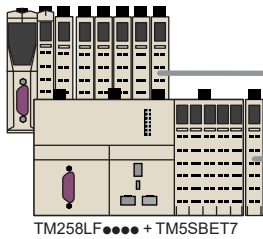

TM258LF + TM5SBET7

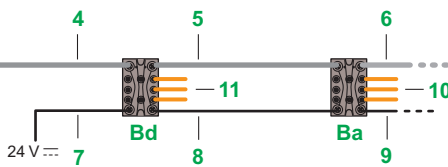

- A Power distribution block
- Ba Analog I/O expansion block
- Bd Digital I/O expansion block
- Bi CANopen interface block

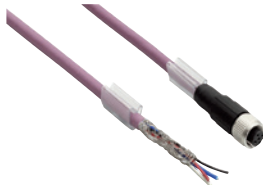

TCSCCN2FNX1SA

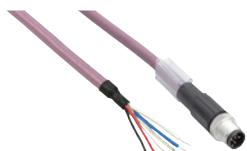

TCSCCN1MNX1SA

Cables for connection to the CANopen bus

Designation	Description	Item	Length m/ft	Reference	Weight kg/lb		
CANopen bus connection cables (bus IN)	Equipped with 1 A-coded 5-way angled female M12 connector at one end and flying leads at the other	1	1/3.28	TCSCCN2FNX1SA	0.089/0.196		
			3/9.843	TCSCCN2FNX3SA	0.195/0.430		
			10/32.81	TCSCCN2FNX10SA	0.563/1.241		
			25/82.02	TCSCCN2FNX25SA	1.352/2.981		
	Equipped with 1 A-coded 5-way straight female M12 connector at one end and flying leads at the other	1	1/3.28	TCSCCN1FNX1SA	0.089/0.196		
			3/9.843	TCSCCN1FNX3SA	0.195/0.430		
			10/32.81	TCSCCN1FNX10SA	0.563/1.241		
			25/82.02	TCSCCN1FNX25SA	1.352/2.981		
		CANopen bus daisy chain cables	Equipped with 2 A-coded 5-way angled M12 connectors, 1 male and 1 female	2	0.3/0.98	TCSCCN2M2F03	0.090/0.198
					1/3.28	TCSCCN2M2F1	0.127/0.280
					2/6.56	TCSCCN2M2F2	0.179/0.395
					5/16.40	TCSCCN2M2F5	0.337/0.743
Equipped with 2 A-coded 5-way straight M12 connectors, 1 male and 1 female	2	0.3/0.98	TCSCCN1M1F03	0.090/0.198			
		1/3.28	TCSCCN1M1F1	0.127/0.280			
		2/6.56	TCSCCN1M1F2	0.179/0.395			
		5/16.40	TCSCCN1M1F5	0.337/0.743			
	CANopen bus connection cables (bus OUT)	Equipped with 1 A-coded 5-way angled male M12 connector at one end and flying leads at the other	3	1/3.28	TCSCCN2MNX1SA	0.089/0.196	
				3/9.843	TCSCCN2MNX3SA	0.195/0.430	
				10/32.81	TCSCCN2MNX10SA	0.563/1.241	
				25/82.02	TCSCCN2MNX25SA	1.352/2.981	
Equipped with 1 A-coded 5-way straight male M12 connector at one end and flying leads at the other	3	1/3.28	TCSCCN1MNX1SA	0.089/0.196			
		3/9.843	TCSCCN1MNX3SA	0.195/0.430			
		10/32.81	TCSCCN1MNX10SA	0.563/1.241			
		25/82.02	TCSCCN1MNX25SA	1.352/2.981			

TM7 bus expansion cables

TM7 bus expansion cables (bus IN)	Equipped with 1 B-coded 4-way angled female M12 connector at one end and flying leads at the other	4	1/3.28	TCSXCN2FNX1E	0.089/0.196
			3/9.843	TCSXCN2FNX3E	0.195/0.430
			10/32.81	TCSXCN2FNX10E	0.563/1.241
			25/82.02	TCSXCN2FNX25E	1.352/2.981
Equipped with 1 B-coded 4-way straight female M12 connector at one end and flying leads at the other		4	1/3.28	TCSXCN1FNX1E	0.089/0.196
			3/9.843	TCSXCN1FNX3E	0.195/0.430
			10/32.81	TCSXCN1FNX10E	0.563/1.241
			25/82.02	TCSXCN1FNX25E	1.352/2.981

Modicon TM7

High-Performance and Safe IP67 Distributed I/O System

Connection components: CANopen and TM7 bus architecture

CANopen architecture

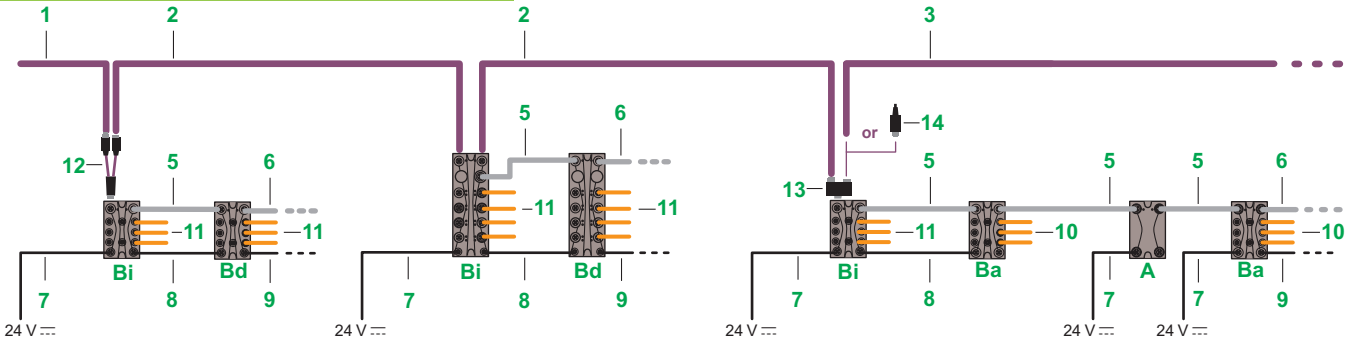

TM7 bus architecture

TM5NCO1 + TM5SBET7

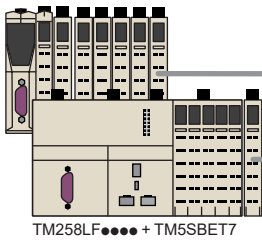

- A** Power distribution block
- Ba** Analog I/O expansion block
- Bd** Digital I/O expansion block
- Bi** CANopen interface block

TM7 bus expansion cables (continued)

Designation	Description	Item	Length m/ft	Reference	Weight kg/lb		
TM7 bus daisy chain cables	Equipped with 2 B-coded 4-way angled M12 connectors, 1 male and 1 female	5	0.3/0.98	TCSXCN2M2F03E	0.090/0.198		
			1/3.28	TCSXCN2M2F1E	0.127/0.280		
			2/6.56	TCSXCN2M2F2E	0.179/0.395		
			5/16.40	TCSXCN2M2F5E	0.337/0.743		
			10/32.81	TCSXCN2M2F10E	0.600/1.323		
	Equipped with 2 B-coded 4-way straight M12 connectors, 1 male and 1 female	5	0.3/0.98	TCSXCN1M1F03E	0.090/0.198		
			1/3.28	TCSXCN1M1F1E	0.127/0.280		
			2/6.56	TCSXCN1M1F2E	0.179/0.395		
			5/16.40	TCSXCN1M1F5E	0.337/0.743		
			10/32.81	TCSXCN1M1F10E	0.600/1.323		
TM7 bus expansion cables (bus OUT)	Equipped with 1 B-coded 4-way angled male M12 connector at one end and flying leads at the other	6	1/3.28	TCSXCN2MNX1E	0.089/0.196		
			3/9.843	TCSXCN2MNX3E	0.195/0.430		
			10/32.81	TCSXCN2MNX10E	0.563/1.241		
			25/82.02	TCSXCN2MNX25E	1.352/2.981		
			1/3.28	TCSXCN1MNX1E	0.089/0.196		
	Equipped with 1 B-coded 4-way straight male M12 connector at one end and flying leads at the other	6	3/9.843	TCSXCN1MNX3E	0.195/0.430		
			10/32.81	TCSXCN1MNX10E	0.563/1.241		
			25/82.02	TCSXCN1MNX25E	1.352/2.981		
			Power distribution cables				
			Power IN power distribution cables	Equipped with 1x 4-way angled female M8 connector at one end and flying leads at the other	7	1/3.28	TCSXCNEFNX1V
3/9.843	TCSXCNEFNX3V	0.105/0.231					
10/32.81	TCSXCNEFNX10V	0.329/0.725					
25/82.02	TCSXCNEFNX25V	0.809/1.784					
1/3.28	TCSXCNDFNX1V	0.041/0.090					
Equipped with 1x 4-way straight female M8 connector at one end and flying leads at the other	7	3/9.843	TCSXCNDFNX3V	0.105/0.231			
		10/32.81	TCSXCNDFNX10V	0.329/0.725			
		25/82.02	TCSXCNDFNX25V	0.809/1.784			
		Power daisy chain cables					
		Power daisy chain cables	Equipped with 2x 4-way angled M8 connectors, 1 male and 1 female	8	0.3/0.98	TCSXCNEMEF03V	0.028/0.062
1/3.28	TCSXCNEMEF1V				0.050/0.110		
2/6.56	TCSXCNEMEF2V				0.082/0.181		
5/16.40	TCSXCNEMEF5V				0.178/0.392		
10/32.81	TCSXCNEMEF10V				0.338/0.745		
Equipped with 2x 4-way straight M8 connectors, 1 male and 1 female	8	15/49.21	TCSXCNEMEF15V	0.498/1.098			
		0.3/0.98	TCSXCNDMDF03V	0.105/0.231			
		1/3.28	TCSXCNDMDF1V	0.329/0.725			
		2/6.56	TCSXCNDMDF2V	0.809/1.784			
		5/16.40	TCSXCNDMDF5V	0.105/0.231			
10/32.81	TCSXCNDMDF10V	0.329/0.725					
15/49.21	TCSXCNDMDF15V	0.809/1.784					



Modicon TM7

High-Performance and Safe IP67 Distributed I/O System

Connection components: CANopen and TM7 bus architecture

CANopen architecture

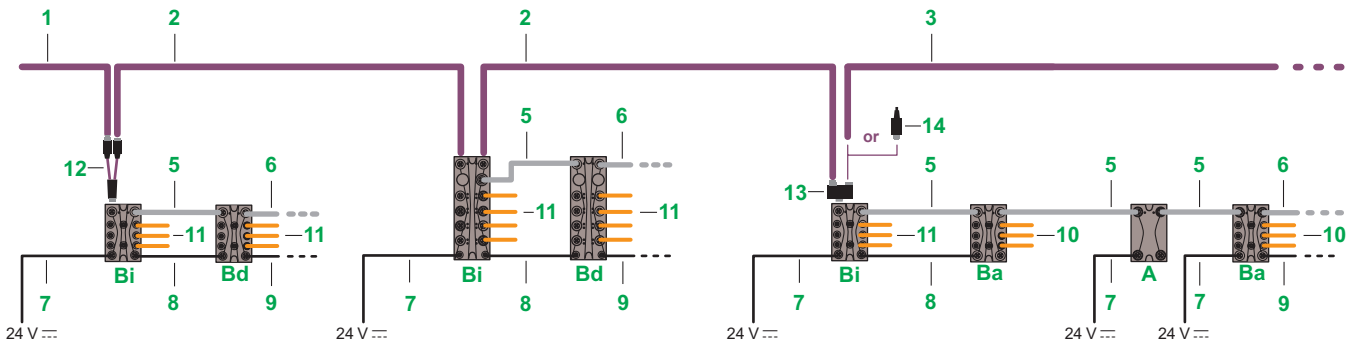

TM7 bus architecture

TM5NCO1 + TM5SBET7

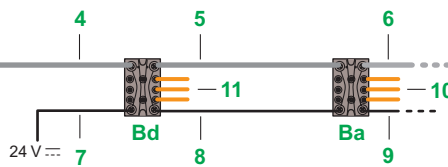
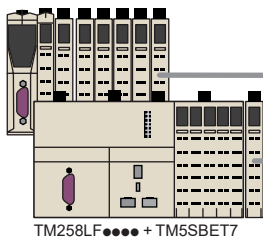

- A Power distribution block
- Ba Analog I/O expansion block
- Bd Digital I/O expansion block
- Bi CANopen interface block

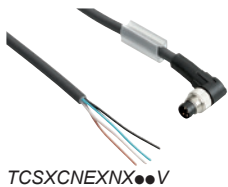

TCSXCNEXNX●●V



TCSXCN1M●●SA



TM7ACYCJ



TM7ACTHA



TM7ACYC

Power distribution cables

Designation	Description	Item	Length m/ft	Reference	Weight kg/lb
Power OUT power distribution cables	Equipped with 1x 4-way angled male M8 connector at one end and flying leads at the other	9	1/3.28	TCSXCNEXNX1V	0.041/0.090
			3/9.843	TCSXCNEXNX3V	0.105/0.231
			10/32.81	TCSXCNEXNX10V	0.329/0.725
			25/82.02	TCSXCNEXNX25V	0.809/1.784
	Equipped with 1x 4-way straight male M8 connector at one end and flying leads at the other	9	1/3.28	TCSXCNDMNX1V	0.041/0.090
			3/9.843	TCSXCNDMNX3V	0.105/0.231
			10/32.81	TCSXCNDMNX10V	0.329/0.725
			25/82.02	TCSXCNDMNX25V	0.809/1.784

Cables for connecting analog sensors and actuators

Designation	Description	Item	Length m/ft	Reference	Weight kg/lb
Cables for connecting sensors and actuators	Equipped with 1 A-coded 5-way angled male M12 connector at one end and flying leads at the other	10	2/6.56	TCSXCN2M2SA	0.143/0.315
			5/16.40	TCSXCN2M5SA	0.258/0.569
			15/49.21	TCSXCN2M15SA	0.546/1.204
	Equipped with one A-coded 5-way straight male M12 connector at one end and flying leads at the other	10	2/6.56	TCSXCN1M2SA	0.143/0.315
			5/16.40	TCSXCN1M5SA	0.258/0.569
			15/49.21	TCSXCN1M15SA	0.546/1.204

Cables for connecting digital sensors and actuators

Please refer to the "Detection for OsiSense automation solutions" catalog, ref. [MKTED210041EN](#) 11

Accessories

Designation	Composition	Item	Reference	Weight kg/lb
CAN bus Y cable	Equipped with 2x 5-way M12 connectors, 1 male and 1 female at one end and 1x 5-way male M12 connector at the other end	12	TM7ACYCJ	0.031/0.068
CAN Y connector	For connecting 2x M12 connectors, 1 male and 1 female, to a male M12 connector on the expansion block	13	TM7ACYC	0.100/0.220
Line terminator (for end of bus)	Equipped with 1x 5-way male M12 connector	14	TM7ACTLA	0.023/0.051
Connector with temperature probe for measurement by thermocouple (1)	Equipped with 1x 5-way male M12 connector	-	TM7ACTHA	0.100/0.220

(1) For use with the TM7BAI4PLA expansion block for measuring the temperature of the connector with compensation

Modicon TM7

High-Performance and Safe IP67 Distributed I/O System

Separate parts



TM7ACMP

Separate parts

Description	Composition	Unit reference	Weight kg/lb
Sealing plugs (1)	For M8 connector on Modicon TM7 blocks Pack of 50	TM7ACCB	0.100/0.220
	For M12 connector on Modicon TM7 blocks Pack of 50	TM7ACCA	0.100/0.220
Plate for mounting on symmetrical DIN rail	For Modicon TM7 blocks	TM7ACMP	0.020/0.044
	For Modicon TM7 blocks Pack of 10	TM7ACMP10	0.200/0.441
Screwdrivers	For tightening the rings on M8 and M12 connectors to the correct torque Pack of 2	TM7ACTW	0.198/0.437

(1) The use of sealing plugs ensures that unused connectors on Modicon TM7 IP67 blocks have IP67 protection.

T	
TCSCCN1FNX1SA	26
TCSCCN1FNX3SA	26
TCSCCN1FNX10SA	26
TCSCCN1FNX25SA	26
TCSCCN1M1F1	26
TCSCCN1M1F2	26
TCSCCN1M1F03	26
TCSCCN1M1F5	26
TCSCCN1M1F10	26
TCSCCN1M1F15	26
TCSCCN1MNX1SA	26
TCSCCN1MNX3SA	26
TCSCCN1MNX10SA	26
TCSCCN1MNX25SA	26
TCSCCN2FNX1SA	26
TCSCCN2FNX3SA	26
TCSCCN2FNX10SA	26
TCSCCN2FNX25SA	26
TCSCCN2M2F1	26
TCSCCN2M2F2	26
TCSCCN2M2F03	26
TCSCCN2M2F5	26
TCSCCN2M2F10	26
TCSCCN2M2F15	26
TCSCCN2MNX1SA	26
TCSCCN2MNX3SA	26
TCSCCN2MNX10SA	26
TCSCCN2MNX25SA	26
TCSXCN1FNX1E	26
TCSXCN1FNX3E	26
TCSXCN1FNX10E	26
TCSXCN1FNX25E	26
TCSXCN1M1F1E	27
TCSXCN1M1F2E	27
TCSXCN1M1F03E	27
TCSXCN1M1F5E	27
TCSXCN1M1F10E	27
TCSXCN1M1F15E	27
TCSXCN1M2SA	28
TCSXCN1M5SA	28
TCSXCN1M15SA	28
TCSXCN1MNX1E	27
TCSXCN1MNX3E	27
TCSXCN1MNX10E	27
TCSXCN1MNX25E	27
TCSXCN2FNX1E	26
TCSXCN2FNX3E	26
TCSXCN2FNX10E	26
TCSXCN2FNX25E	26
TCSXCN2M2F1E	27
TCSXCN2M2F2E	27
TCSXCN2M2F03E	27
TCSXCN2M2F5E	27
TCSXCN2M2F10E	27
TCSXCN2M2F15E	27
TCSXCN2M2SA	28
TCSXCN2M5SA	28
TCSXCN2M15SA	28
TCSXCN2MNX1E	27
TCSXCN2MNX3E	27
TCSXCN2MNX10E	27
TCSXCN2MNX25E	27
TCSXCNDFNX1V	27
TCSXCNDFNX3V	27
TCSXCNDFNX10V	27
TCSXCNDFNX25V	27
TCSXCNDMDF1V	27
TCSXCNDMDF2V	27
TCSXCNDMDF03V	27
TCSXCNDMDF5V	27
TCSXCNDMDF10V	27
TCSXCNDMDF15V	27
TCSXCNDMNX1V	28
TCSXCNDMNX3V	28
TCSXCNDMNX10V	28
TCSXCNDMNX25V	28
TCSXCNEFNX1V	27
TCSXCNEFNX3V	27
TCSXCNEFNX10V	27
TCSXCNEFNX25V	27
TCSXCNEMEF1V	27
TCSXCNEMEF2V	27
TCSXCNEMEF03V	27
TCSXCNEMEF5V	27
TCSXCNEMEF10V	27
TCSXCNEMEF15V	27
TCSXCNEXNX1V	28
TCSXCNEXNX3V	28
TCSXCNEXNX10V	28
TCSXCNEXNX25V	28
TM7ACCA	29
TM7ACCB	29
TM7ACMP	29
TM7ACMP10	29
TM7ACTHA	28
TM7ACTLA	28
TM7ACTW	29
TM7ACYC	28
TM7ACYCJ	28
TM7BAI4CLA	17
TM7BAI4PLA	17
TM7BAI4TLA	17
TM7BAI4VLA	17
TM7BAM4CLA	17
TM7BAM4VLA	17
TM7BAO4CLA	17
TM7BAO4VLA	17
TM7BDI8B	13
TM7BDI16A	13
TM7BDI16B	13
TM7BDM8B	13
TM7BDM16A	13
TM7BDM16B	13
TM7BDO8TAB	13
TM7NCOM08B	25
TM7NCOM16A	25
TM7NCOM16B	25
TM7SDI8DFS	19
TM7SDM12DTFS	19
TM7SPS1A	18

Life Is On



Learn more about our products at
www.schneider-electric.com

The information provided in this documentation contains general descriptions and/or technical characteristics of the performance of the products contained herein. This documentation is not intended as a substitute for and is not to be used for determining suitability or reliability of these products for specific user applications. It is the duty of any such user or integrator to perform the appropriate and complete risk analysis, evaluation and testing of the products with respect to the relevant specific application or use thereof. Neither Schneider Electric nor any of its affiliates or subsidiaries shall be responsible or liable for misuse of the information contained herein.

Design: Schneider Electric
Photos: Schneider Electric

Schneider Electric Industries SAS

Head Office
35, rue Joseph Monier - CS 30323
F-92500 Rueil-Malmaison Cedex
France

DIA3ED2140405EN
January 2020 - V2.0