

High Voltage LED Series Chip on Board

LC003D – Gen.1



High efficacy COB LED package
well-suited for use in spotlight applications

Features & Benefits

- Chip on Board (COB) solution makes it easy to design in
- Simple assembly reduces manufacturing cost
- Low thermal resistance
- InGaN/GaN MQW LED with long time reliability

Applications

- Spotlight / Downlight
- LED Retrofit Bulbs
- Outdoor Illumination



Table of Contents

1.	Characteristics	-----	3
2.	Product Code Information	-----	5
3.	Typical Characteristics Graphs	-----	9
4.	Outline Drawing & Dimension	-----	12
5.	Reliability Test Items & Conditions	-----	13
6.	Label Structure	-----	14
7.	Packing Structure	-----	15
8.	Precautions in Handling & Use	-----	17

1. Characteristics

a) Absolute Maximum Rating

Item	Symbol	Rating	Unit	Condition
Ambient / Operating Temperature	T_a	-40 ~ +105	°C	-
Storage Temperature	T_{stg}	-40 ~ +120	°C	-
LED Junction Temperature	T_J	140	°C	-
Case Temperature	T_c	105	°C	-
Forward Current	I_F	230	mA	-
Power Dissipation	P_D	8.6	W	-
ESD (HBM)	-	±2	kV	-
ESD (MM)	-	±0.5	kV	-

b) Electro-optical Characteristics ($I_F = 90 \text{ mA}$, $T_J = 85 \text{ °C}$)

Item	Unit	Rank	Min.	Typ.	Max.
Forward Voltage (V_F)	V	YZ	31.8	34.6	37.5
Color Rendering Index (R_a)	-	5	80	-	-
		7	90	-	-
Thermal Resistance (junction to chip point)	°C/W		-	4.2	-
Beam Angle	°		-	115	-
Nominal Power	W			3.1	

Notes:

- 1) The COB is tested in pulsed condition at rated test current (10 ms pulse width) and rated temperature ($T_J = T_C = T_a = 85 \text{ °C}$)
- 2) Samsung maintains measurement tolerance of: forward voltage = ±5 %, CRI = ±1
- 3) Refer to the derating curve, '3. Typical Characteristics Graph' designed within the range.

c) Luminous Flux Characteristics ($I_F = 90 \text{ mA}$)

CRI (R_a) Min.	Nominal CCT (K)	Flux Rank	Flux @ $T_J = 85^\circ\text{C}$ (lm)		
			Min.	Typ.	Max.
80	2700	A9	393	413	-
		D1	413	434	-
	3000	B1	413	435	-
		D1	435	457	-
	3500	B2	429	451	-
		D1	451	474	-
	4000	B3	434	457	-
		D1	457	480	-
	5000	B3	439	462	-
		D1	462	485	-
	5700	B3	439	462	-
		D1	462	485	-
	6500	B3	434	457	-
		D1	457	480	-

CRI (R_a) Min.	Nominal CCT (K)	Flux Rank	Flux @ $T_J = 85^\circ\text{C}$ (lm)		
			Min.	Typ.	Max.
90	2700	A3	332	349	-
		D1	349	367	-
	3000	A4	347	365	-
		D1	365	384	-
	3500	A5	358	377	-
		D1	377	396	-
	4000	A6	366	385	-
		D1	385	404	-
	5000	A6	368	387	-
		D1	387	407	-

Notes:

- 1) The COB is tested in pulsed operating condition at rated test current (10 ms pulse width) and rated temperature ($T_J = T_C = 85^\circ\text{C}$).
- 2) Samsung maintains measurement tolerance of: Luminous flux = $\pm 7\%$, CRI = ± 1

2. Product Code Information

1	2	3	4	5	6	7	8	9	10	11	12	13	14	15	16	17	18
S	P	H	W	H	A	H	D	N	A	2	5	Y	Z	W	3	A	9

Digit	PKG Information	Code	Specification
1 2 3	Samsung Package High Power	SPH	
4 5	Color	WH	White
6	Product Version	A	
7 8	Form Factor	HD	COB
9	Lens Type	N	No lens
10	Wattage or Model	A	LC003D
11	Internal Code	2	
12	CRI & Sorting Temperature	5 7	Min. 80 (85°C) Min. 90 (85°C)
13 14	Forward Voltage (V)	YZ	31.8~37.5
15	CCT (K)	W V U T R Q P	2700K 3000K 3500K 4000K 5000K 5700K 6500K
16	MacAdam Step	2 3	MacAdam 2-step MacAdam 3-step
17 18	Luminous Flux (Lm)	A3 A4 A5 A6 A9 B1 B2 B3 D1	Min. 330 Min. 340 Min. 350 Min. 360 Min. 390 Min. 410 Min. 420 Min. 430 Add rank

a) Binning Structure ($I_F = 90 \text{ mA}$, $T_J = 85 \text{ }^\circ\text{C}$)

CRI (R_a) Min.	Nominal CCT (K)	Product Code	V_F Rank	Color Rank	Flux Rank	Flux Range (Φ_v , lm)
80	2700	SPHWAHDNA25YZW2A9	YZ	W2	A9	393 ~
		SPHWAHDNA25YZW3A9		W3		
		SPHWAHDNA25YZW2D1		W2	D1	
		SPHWAHDNA25YZW3D1		W3		
	3000	SPHWAHDNA25YZV2B1	YZ	V2	B1	413 ~
		SPHWAHDNA25YZV3B1		V3		
		SPHWAHDNA25YZV2D1		V2	D1	
		SPHWAHDNA25YZV3D1		V3		
	3500	SPHWAHDNA25YZU2B2	YZ	U2	B2	429 ~
		SPHWAHDNA25YZU3B2		U3		
		SPHWAHDNA25YZU2D1		U2	D1	
		SPHWAHDNA25YZU3D1		U3		
	4000	SPHWAHDNA25YZT2B3	YZ	T2	B3	434 ~
		SPHWAHDNA25YZT3B3		T3		
		SPHWAHDNA25YZT2D1		T2	D1	
		SPHWAHDNA25YZT3D1		T3		
	5000	SPHWAHDNA25YZR3B3	YZ	R3	B3	439 ~
		SPHWAHDNA25YZR3D1			D1	462 ~
	5700	SPHWAHDNA25YZQ3B3	YZ	Q3	B3	439 ~
		SPHWAHDNA25YZQ3D1			D1	462 ~
6500	SPHWAHDNA25YZP3B3	YZ	P3	B3	434 ~	
	SPHWAHDNA25YZP3D1			D1	457 ~	

CRI (R _a) Min.	Nominal CCT (K)	Product Code	V _F Rank	Color Rank	Flux Rank	Flux Range (Φ _v , lm)
90	2700	SPHWHHDNA27YZW2A3	YZ	W2	A3	332 ~
		SPHWHHDNA27YZW3A3		W3		
		SPHWHHDNA27YZW2D1		W2	D1	349 ~
		SPHWHHDNA27YZW3D1		W3		
	3000	SPHWHHDNA27YZV2A4	YZ	V2	A4	347 ~
		SPHWHHDNA27YZV3A4		V3		
		SPHWHHDNA27YZV2D1		V2	D1	365 ~
		SPHWHHDNA27YZV3D1		V3		
	3500	SPHWHHDNA27YZU2A5	YZ	U2	A5	358 ~
		SPHWHHDNA27YZU3A5		U3		
		SPHWHHDNA27YZU2D1		U2	D1	377 ~
		SPHWHHDNA27YZU3D1		U3		
	4000	SPHWHHDNA27YZT2A6	YZ	T2	A6	366 ~
		SPHWHHDNA27YZT3A6		T3		
		SPHWHHDNA27YZT2D1		T2	D1	385 ~
		SPHWHHDNA27YZT3D1		T3		
	5000	SPHWHHDNA27YZR3A6	YZ	R3	A6	368 ~
		SPHWHHDNA27YZR3D1		R3	D1	387 ~

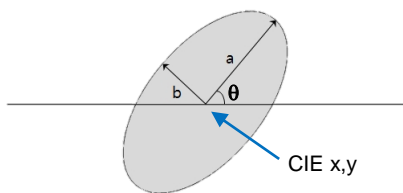
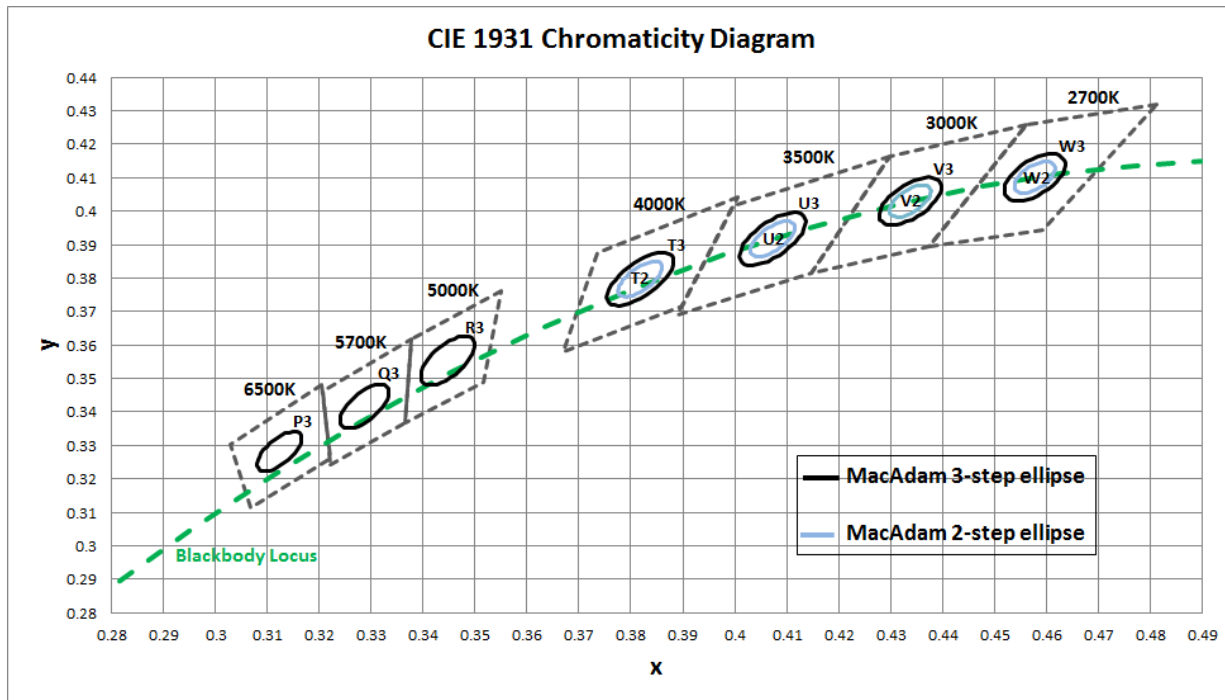
b) Chromaticity Region & Coordinates ($I_F = 90 \text{ mA}$, $T_J = 85 \text{ }^\circ\text{C}$)

MacAdam Ellipse (W2, W3)					
Step	CIE x	CIE y	θ	a	b
2-step	0.4578	0.4101	53.70	0.0054	0.0028
3-step	0.4578	0.4101	53.70	0.0081	0.0042

MacAdam Ellipse (V2, V3)					
Step	CIE x	CIE y	θ	a	b
2-step	0.4338	0.403	53.22	0.0056	0.0027
3-step	0.4338	0.4030	53.22	0.0083	0.0041

MacAdam Ellipse (U2, U3)					
Step	CIE x	CIE y	θ	a	b
2-step	0.4073	0.3917	54.00	0.0062	0.0028
3-step	0.4073	0.3917	54.00	0.0093	0.0041

MacAdam Ellipse (T2, T3)					
Step	CIE x	CIE y	θ	a	b
2-step	0.3818	0.3797	53.72	0.0063	0.0027
3-step	0.3818	0.3797	53.72	0.0094	0.0040

MacAdam Ellipse (R3)					
Step	CIE x	CIE y	θ	a	b
3-step	0.3447	0.3553	59.62	0.0082	0.0035

MacAdam Ellipse (Q3)					
Step	CIE x	CIE y	θ	a	b
3-step	0.3287	0.3417	59.0950	0.0075	0.0032

MacAdam Ellipse (P3)					
Step	CIE x	CIE y	θ	a	b
3-step	0.3123	0.3282	58.5700	0.0067	0.0029

Note:

Samsung maintains measurement tolerance of: $C_x, C_y = \pm 0.005$

3. Typical Characteristics Graphs

a) Spectrum Distribution ($I_f = 90 \text{ mA}$, $T_J = 85 \text{ }^\circ\text{C}$)

CCT: 2700 K (80 CRI)

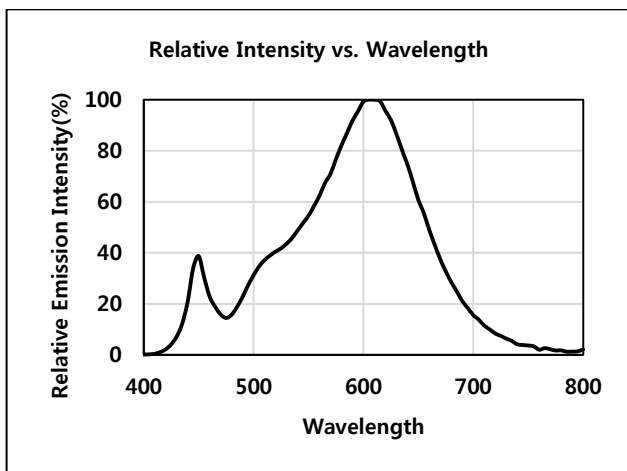

CCT: 3000 K (80 CRI)

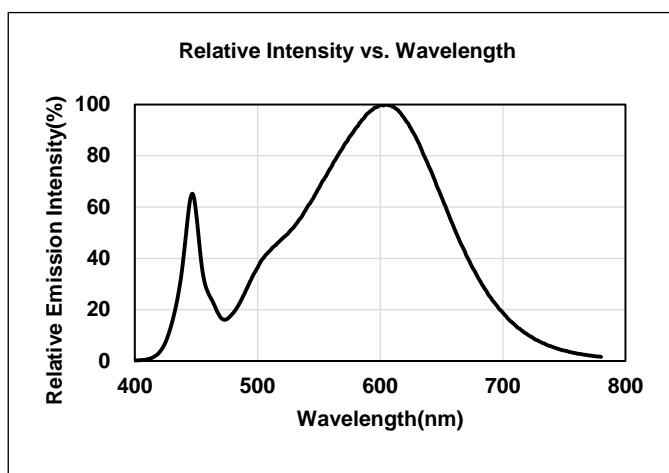

CCT: 3500 K (80 CRI)

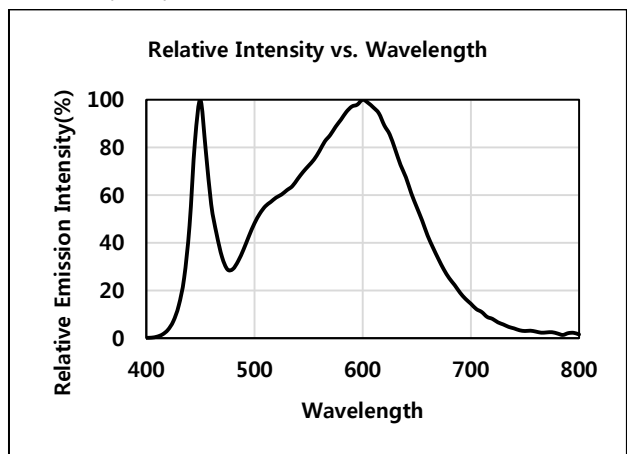

CCT: 4000 K (80 CRI)

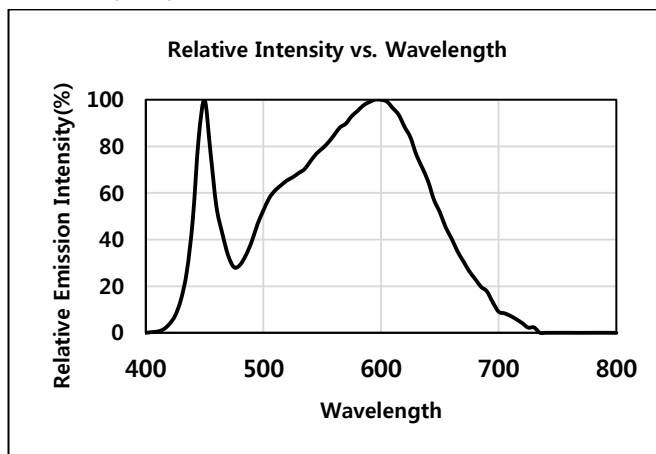

CCT: 5000 K (80 CRI)

CCT: 5700 K (80 CRI)

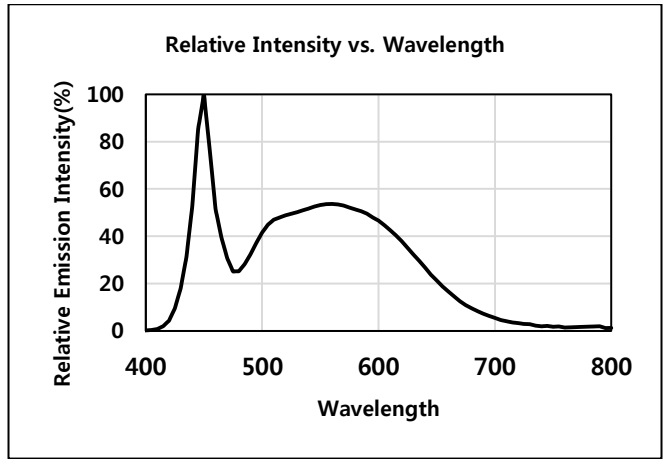
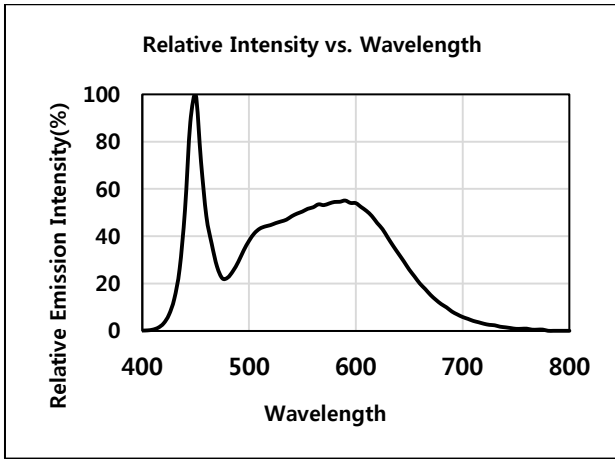

CCT: 6500 K (80 CRI)

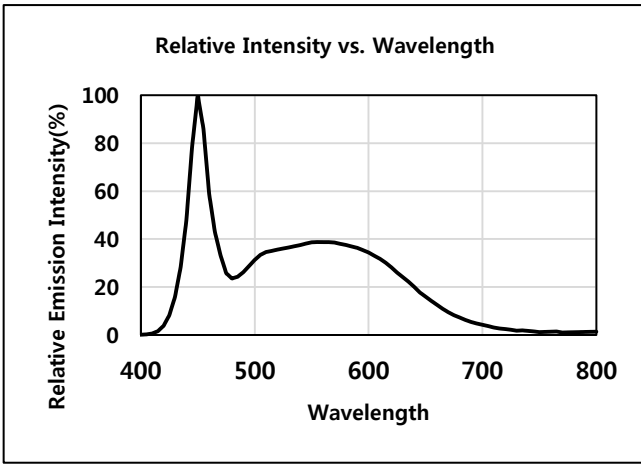

b) Forward Current Characteristics ($T_J = 85^\circ\text{C}$)

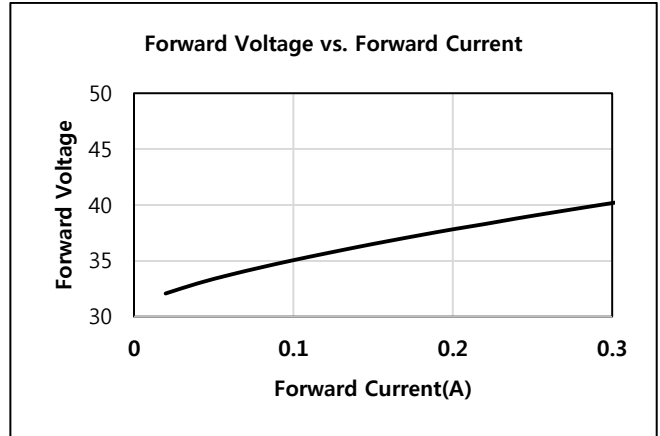
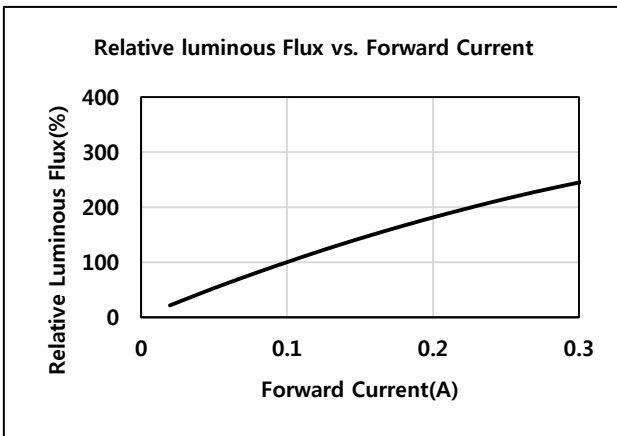

C) Temperature Characteristics ($I_F = 90\text{mA}$)

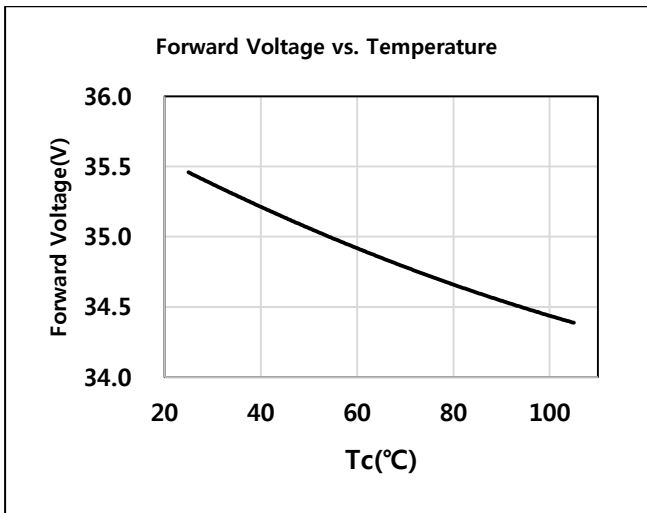
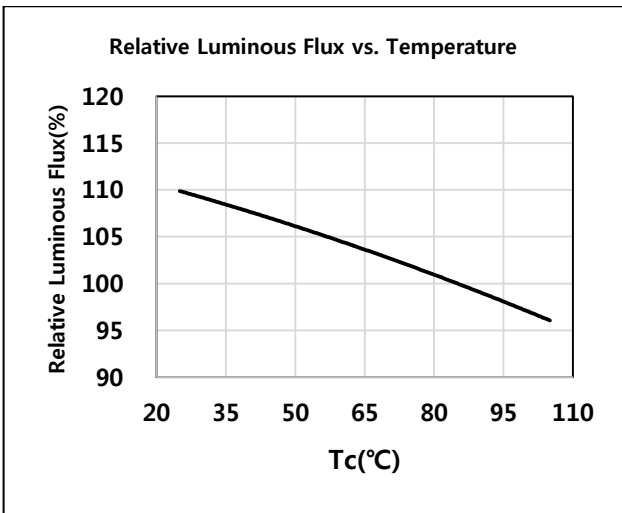

d) Color Shift Characteristics $T_J = 85\text{ }^\circ\text{C}$, $I_F = 90\text{mA}$, $\text{CRI} = 80+$

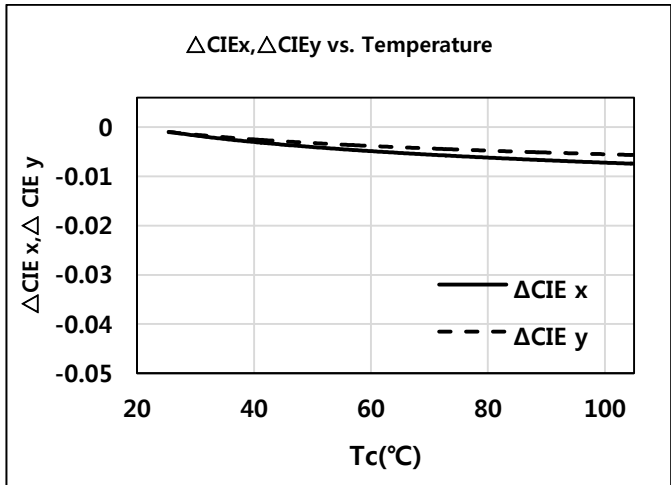
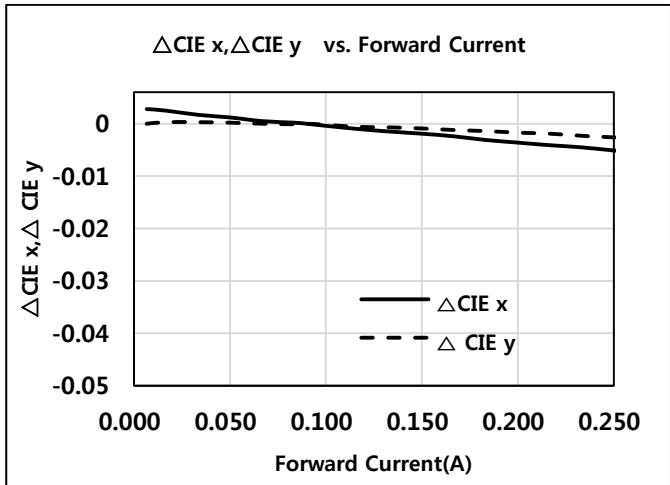

e) Beam Angle Characteristics ($I_F = 90\text{ mA}$, $T_J = 85\text{ }^\circ\text{C}$)

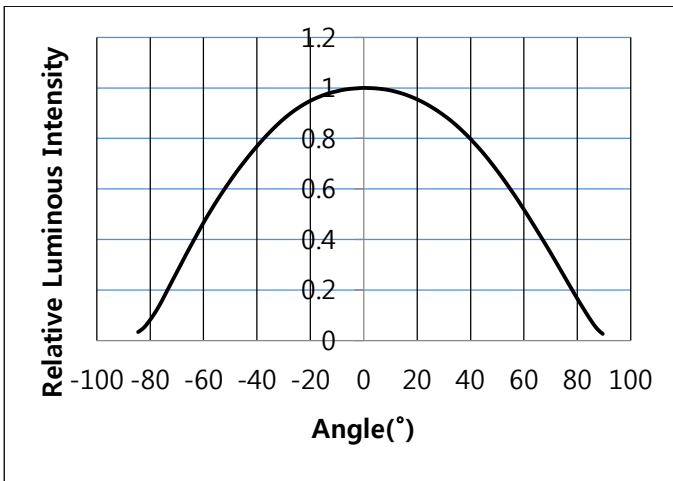

f) Derating Characteristics

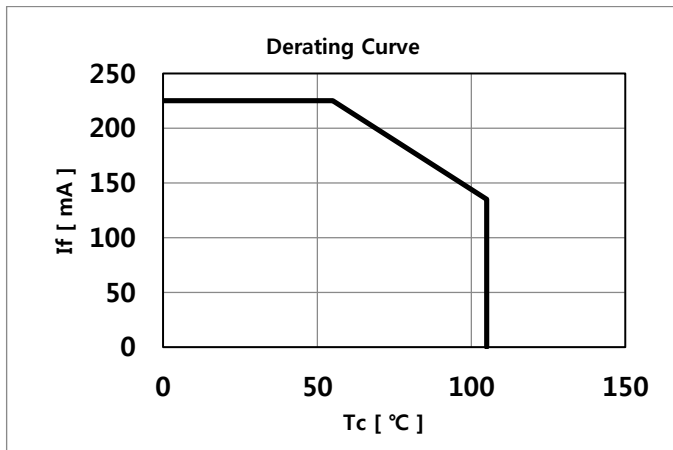

4. Outline Drawing & Dimension

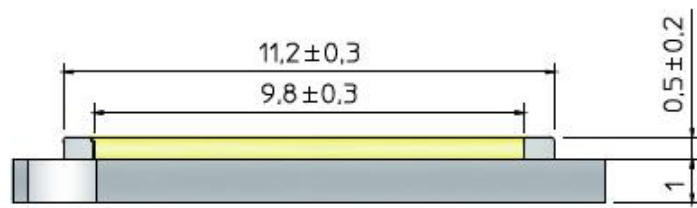
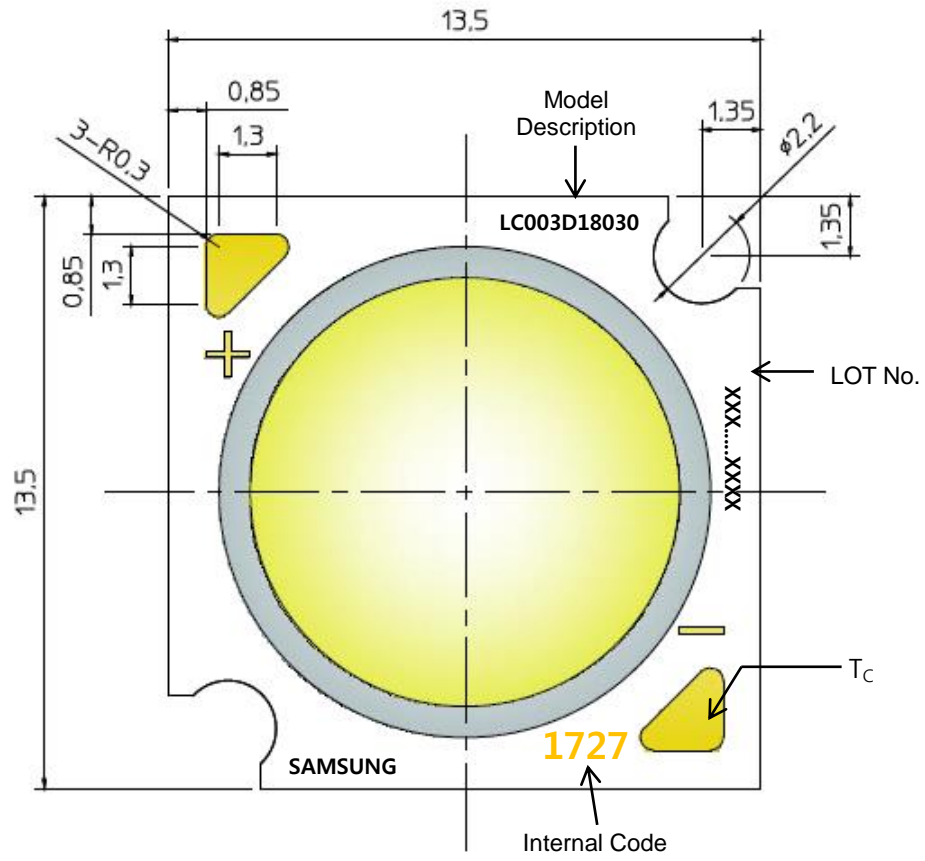

- 1. Unit: mm
- 2. Tolerance: ± 0.30 mm

Item	Dimension	Tolerance	Unit
Length	13.5	±0.15	mm
Width	13.5	±0.15	mm
Height	1.50	±0.20	mm
Light Emitting Surface (LES) Diameter	9.8	±0.30	mm

Note: Denoted product information above is only an example
 (LC003D18030 : LC003D, CRI80+, 3000K)

5. Reliability Test Items & Conditions

a) Test Items

Test Item	Test Condition	Test Hour / Cycle
High Temperature Humidity Life Test	60 °C, 90 % RH,, DC Derating, I_F	1000 h
High Temperature Life Test	85 °C, DC Derating, I_F	1000 h
Low Temperature Life Test	-40 °C, DC , $I_F = 160$ mA	1000 h
Pulsed Operating Life Test	55 °C, Pulse width 100 μ s, duty cycle 3 %	1000 h
High Temperature Storage	120 °C	1000 h
Low Temperature Storage	-40 °C	1000 h
Temperature Humidity Storage	60 °C, 90% RH	1000h
Temperature Cycle On/Off Test	-40 °C / 85 °C each 20 min, 30 min transfer power on/off each 5 min, DC Derating, $I_F = \text{max}$	100 cycles
ESD (HBM)	R_1 : 10 M Ω R_2 : 1.5 k Ω C: 100 pF V: ± 2 kV	5 times
ESD (MM)	R_1 : 10 M Ω R_2 : 0 k Ω C: 200 pF V: ± 0.2 kV	5 times
Vibration Test	20 ~ 80 Hz (displacement: 0.06 inch, max. 20 g) 80 ~ 2 kHz (max. 20 g) min. frequency \leftrightarrow max. frequency 4 min transfer	4 times
Mechanical Shock Test	1500 g, 0.5 ms each of the 6 surfaces (3 axis x 2 sides)	5 times
Sulfur Resistance	25 °C, 75%, H2S 15 ppm	504h

b) Criteria for Judging the Damage

Item	Symbol	Test Condition ($T_c = 25$ °C)	Limit	
			Min.	Max.
Forward Voltage	V_F	$I_F = 90$ mA	L.S.L. * 0.9	U.S.L. * 1.1
Luminous Flux	Φ_v	$I_F = 90$ mA	L.S.L * 0.7	U.S.L * 1.3

6. Label Structure

a) Label Structure

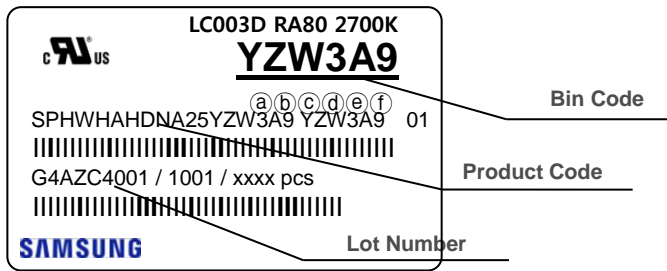

Note: Denoted bin code and product code above is only an example (see description on page 5)

Bin Code:

- ⒶⒷ: Forward Voltage bin (refer to page 11)
- ⒸⒹ: Chromaticity bin (refer to page 9-10)
- ⒺⒻ: Luminous Flux bin (refer to page 6)

b) Lot Number

The lot number is composed of the following characters:

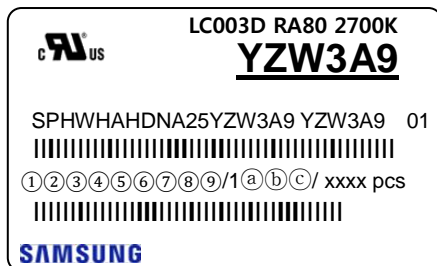

① ③④⑤⑥⑦⑧⑨ / 1ⒶⒷⒸ / xxxx pcs

- ① : Production site (S: Giheung, Korea, G: Tianjin, China)
- ② : 4 (LED)
- ③ : Product state (A: Normal, B: Bulk, C: First Production, R: Reproduction, S: Sample)
- ④ : Year (Z: 2015, A: 2016, B: 2017...)
- ⑤ : Month (1~9, A, B, C)
- ⑥⑦⑧⑨ : Day (1~9, A, B~V)
- ⒶⒷⒸ : Product serial number (001 ~ 999)

7. Packing Structure

Packing material	Max. quantity in pcs of COB	Dimension(mm)			
		Length	Width	Height	Tolerance
Tray	30	160	180	10	1.0
Aluminum Bag	60(2 trays)	210	241		10
Inner Box	240	230	84	260	2
Outer Box	2400	476	445	272	5

a) Packing Structure

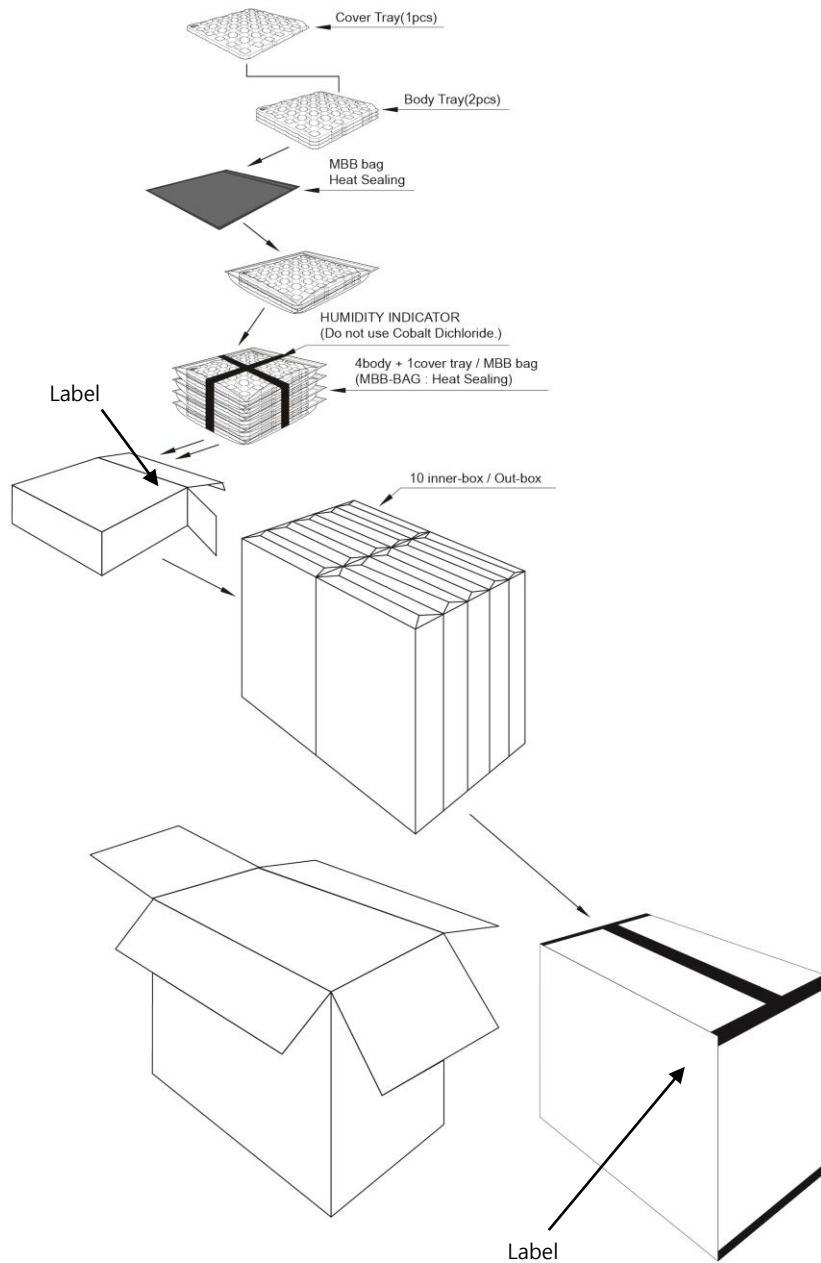

b) Tray

① Cover

② Body

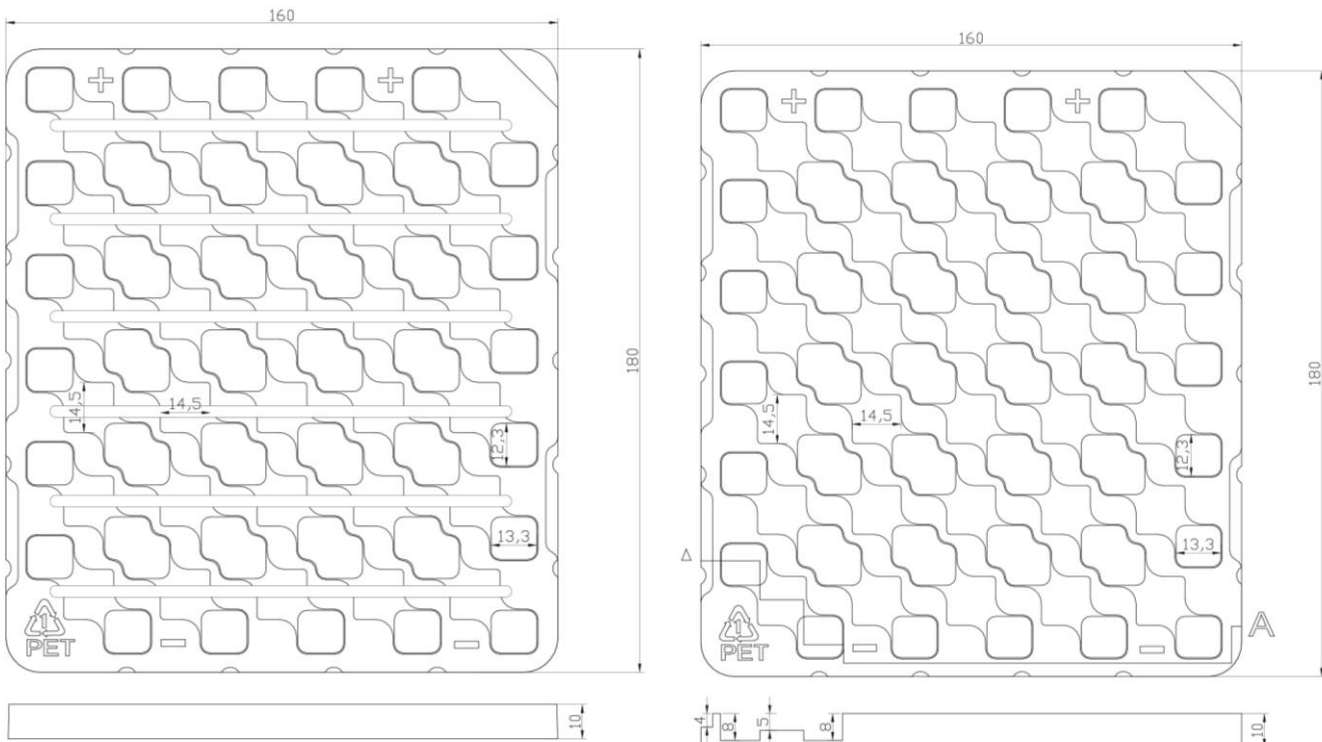

c) Aluminum Vinyl Packing Bag

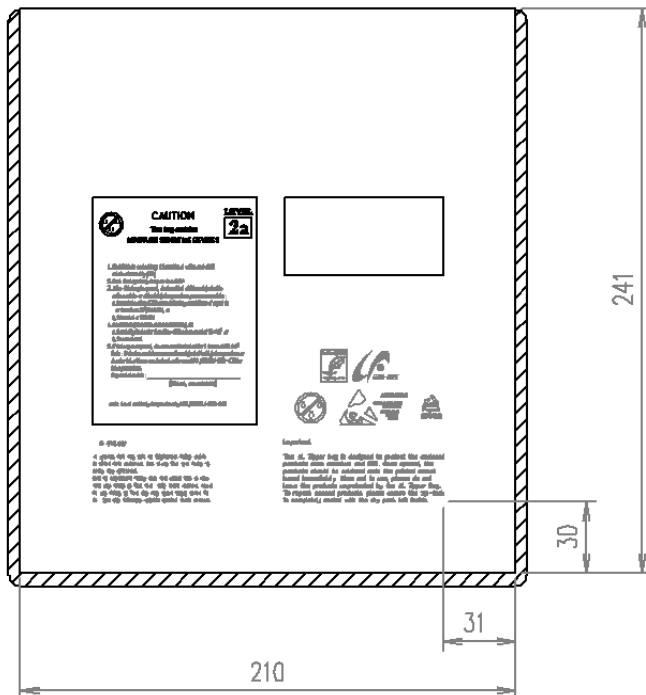

8. Precautions in Handling & Use

- 1) This device should not be used in any type of fluid such as water, oil, organic solvent, etc. When cleaning is required, IPA is recommended as the cleaning agent. Some solvent-based cleaning agent may damage the silicone resins used in the device.
- 2) LEDs must be stored in a clean environment. If the LEDs are to be stored for three months or more after being shipped from Samsung, they should be packed with a nitrogen-filled container (shelf life of sealed bags is 12 months at temperature 0~40 °C, 0~90 % RH).
- 3) After storage bag is opened, device subjected to soldering, solder reflow, or other high temperature processes must be:
 - a. Mounted within 672 hours (28 days) at an assembly line with a condition of no more than 30 °C / 60 % RH, or
 - b. Stored at <10 % RH
- 4) Repack unused products with anti-moisture packing, fold to close any opening and then store in a dry place.
- 5) Devices require baking before mounting, if humidity card reading is >60 % at 23 ± 5 °C.
- 6) Devices must be baked for 1 hour at 60 ± 5 °C, if baking is required.
- 7) The LEDs are sensitive to the static electricity and surge current. It is recommended to use a wrist band or anti-electrostatic glove when handling the LEDs. If voltage exceeding the absolute maximum rating is applied to LEDs, it may cause damage or even destruction to LED devices. Damaged LEDs may show some unusual characteristics such as increase in leakage current, lowered turn-on voltage, or abnormal lighting of LEDs at low current.
- 8) The thermal management is one of the most critical factors for the LED lighting system. Especially the LED junction temperature should not exceed the absolute maximum rating while operation of LED lighting system.
For more information, please refer to Application Note 'Mechanical & Thermal Guide for COB'.
- 9) In case of driving LEDs around the minimum current level (I_{f_min}), chips might exhibit different brightness due to the variation in I-V characteristics of each one. This is normal and does not adversely affect the performance of product.
- 10) VOCs (Volatile Organic Compounds) can be generated from adhesives, flux, hardener or organic additives used in luminaires (fixtures). Transparent LED silicone encapsulant is permeable to those chemicals and they may lead to a discoloration of encapsulant when they exposed to heat or light. This phenomenon can cause a significant loss of light emitted (output) from the luminaires. In order to prevent these problems, we recommend users to know the physical properties of materials used in luminaires and they must be carefully selected.
- 11) The resin area is very sensitive, please do not handle, press, touch, rub, clean, or pick by with tweezers on it. Instead, please pick at the handling area as indicated below.

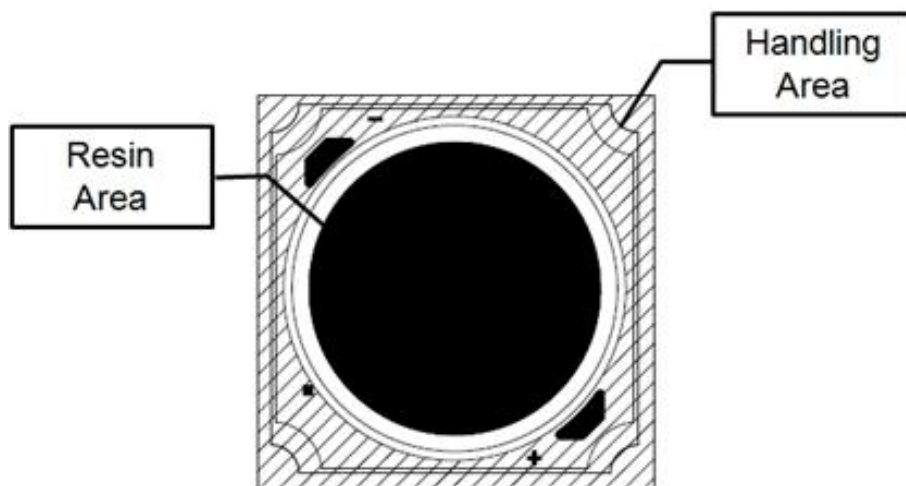

Legal and additional information.

[About Samsung Electronics Co., Ltd.](#)

Samsung Electronics Co., Ltd. inspires the world and shapes the future with transformative ideas and technologies, redefining the worlds of TVs, smartphones, wearable devices, tablets, cameras, digital appliances, printers, medical equipment, network systems and semiconductors.

We are also leading in the Internet of Things space through, among others, our Digital Health and Smart Home initiatives. We employ 307,000 people across 84 countries. To discover more, please visit our official website at www.samsung.com and our official blog at global.samsungtomorrow.com.

Copyright © 2015 Samsung Electronics Co., Ltd. All rights reserved.

Samsung is a registered trademark of Samsung Electronics Co., Ltd.

Specifications and designs are subject to change without notice. Non-metric weights and measurements are approximate. All data were deemed correct at time of creation. Samsung is not liable for errors or omissions. All brand, product, service names and logos are trademarks and/or registered trademarks of their respective owners and are hereby recognized and acknowledged.

Samsung Electronics Co., Ltd.
95, Samsung 2-ro
Giheung-gu
Yongin-si, Gyeonggi-do, 446-711
KOREA

www.samsungled.com

SAMSUNG