

SM34B155K501A

KPS SM SMD Indust X7R HV, Ceramic, 1.5 uF, 10%, 500 VDC, X7R, SMD, Fixed, High Volt, Low ESR, Leaded, Industrial, SM34

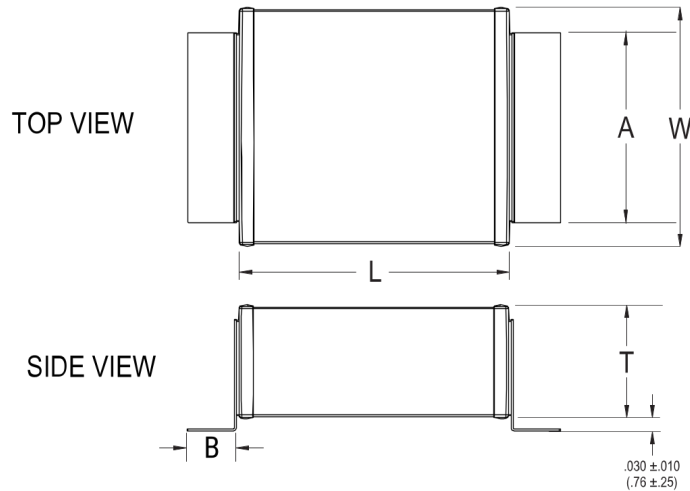

Click [here](#) for the 3D model.

Dimensions	
Chip Size	SM34
L	22.86mm +/-0.762mm
W	10.16mm +/-0.762mm
T	5.588mm MAX
A	7.62mm MAX
B	2.54mm +/-0.508mm

Packaging Specifications	
Packaging	Tray
Packaging Quantity	10

General Information	
Series	KPS SM SMD Indust X7R HV
Style	SMD Chip
Description	SMD, Fixed, High Volt, Low ESR, Leaded, Industrial
Features	High Voltage, Low ESR, Industrial Grade
RoHS	With Exemptions
REACH	SVHC (Pb - CAS 7439-92-1)
Termination	Silver
Marking	No
AEC-Q200	No
Shelf Life	78 Weeks
MSL	1

Specifications	
Capacitance	1.5 uF
Capacitance Tolerance	10%
Voltage DC	500 VDC
Dielectric Withstanding Voltage	750 VDC
Temperature Range	-55/+125°C
Temperature Coefficient	X7R
Dissipation Factor	2.5%
Insulation Resistance	700 MOhms
Quality Factor	3

Statements of suitability for certain applications are based on our knowledge of typical operating conditions for such applications, but are not intended to constitute - and we specifically disclaim - any warranty concerning suitability for a specific customer application or use. This information is intended for use only by customers who have the requisite experience and capability to determine the correct products for their application. Any technical advice inferred from this information or otherwise provided by us with reference to the use of our products is given gratis, and we assume no obligation or liability for the advice given or results obtained.