



Quality Products. Service Excellence.

Heavy Duty Enclosure Coupling *HDSSEC Series*



- Cast aluminum.
- Large thrust flange.
- Fastens with 4 hex socket screws.
- Adjustable torque resistance.
- Features a rotation range of 300°.

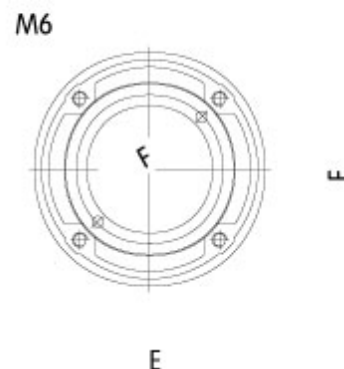
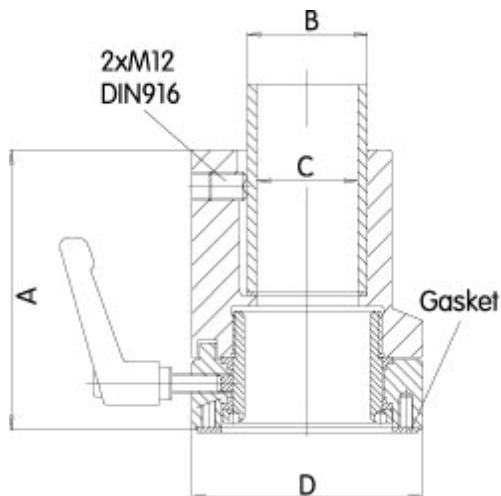

Part No.	System	A	B	C	D	E	F
R147-025-000R	50	115	50	42	96	58	52
R147-025-200R	80	145	80	72	139	87	85

Data subject to change without notice

© 2019. Hammond Manufacturing Ltd. All rights reserved.