

10 9 8 7 6 5 4 3 2 1

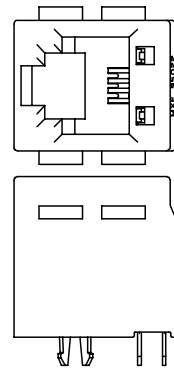

VERSION WITH SPLIT RIBS

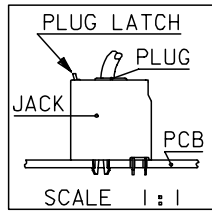
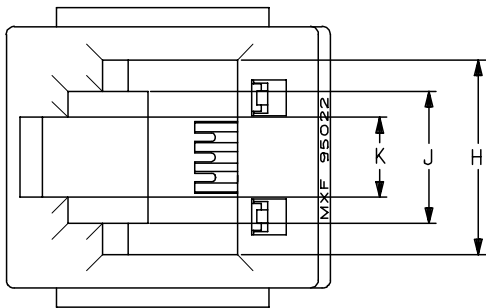
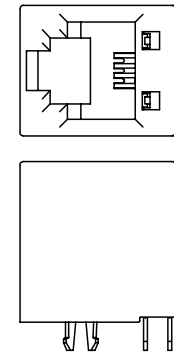

VERSION WITHOUT RIBS

NOTES :

1- MATERIAL:

- HOUSING: POLYESTER FIBER GLASS FILLED 94-V-0  
COLOR BLACK.
- TERMINAL: PHOSPHOR BRONZE.  
FINISH 2  
POST PLATE (0.00127-0.00152)/.000050-.000060  
GOLD IN CONTACT AREA (0.00190)/.000075 MIN.  
PURE TIN IN TAIL AREA BOTH OVER (0.00127)/  
.000050 MIN. NICKEL OVERALL.  
FINISH 7 ONLY ON REQUEST  
POST PLATE 0.00005/.000002 MIN GOLD OVER 0.00076/.000030 MIN  
PALLADIUM NICKEL IN CONTACT AREA. 0.00190/.000075 MIN TIN  
IN TAIL AREA. BOTH OVER 0.00127/.000050 MIN NICKEL OVERALL.
- 2- PC BOARD THICKNESS : (1.57) / .062 .
- 3- JACK FOR MATING WITH F.C.C. 68 PLUGS 90075 MOLEX SERIES .
- 4- PRODUCT SPECIFICATION PS-95003.
- 5- APPLICATION SPECIFICATION AS-95001.
- 6- PACKAGING SPECIFICATION PK-95022. (SHT.1 TRAY PACKAGING)  
PK-95022. (SHT.2 TUBE PACKAGING)
- 7- FOR ILLUSTRATION PURPOSES A 4 CIRCUIT IS SHOWN.
- 8- PACKAGING SPECIFICATION RPK-95022-001 (TUBE PACKAGING).

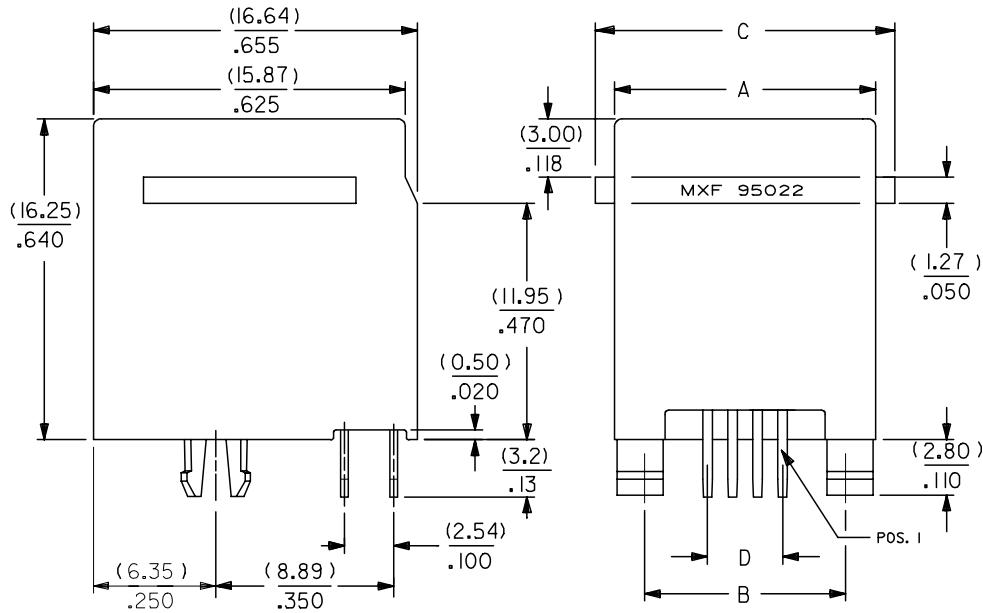

ENTER DESCRIPTION EC NO: MG2004-0207 DRAWN: GECHTEINA CHKD: CARABET APPR: KNOLLER	2004/08/26 2004/08/31 2004/09/08	DESCRIPTION REV	QUALITY SYMBOLS ▽=0 ∇=0
-----------------------------------------------------------------------------------------------	----------------------------------------	--------------------	-------------------------------

GENERAL TOLERANCES (UNLESS SPECIFIED)	DIMENSION STYLE MM/IN	SCALE 4:1	DESIGN UNITS METRIC	THIRD ANGLE PROJECTION
4 PLACES ± --- ± ---	mm INCH	DRAWN BY DP	DATE 88/02/18	TITLE HIGH PROFILE TOP ENTRY JACK
3 PLACES ± --- ± .010		CHECKED BY FB	DATE 88/02/19	
2 PLACES ± 0.25 ± .014		APPROVED BY JB	DATE 88/02/19	
1 PLACE ± 0.35 ± ---		MATERIAL NO.	DOCUMENT NO. SDA-95022	SHEET NO. 1 OF 4
ANGULAR ± 2 °		SEE CHART SHT. 2	MOLEX INCORPORATED	
DRAFT WHERE APPLICABLE MUST REMAIN WITHIN DIMENSIONS				

DRAWN BY DP		DATE 88/02/18	TITLE HIGH PROFILE TOP ENTRY JACK	
CHECKED BY FB		DATE 88/02/19		
APPROVED BY JB		DATE 88/02/19		
MATERIAL NO.		DOCUMENT NO. SDA-95022	SHEET NO. 1 OF 4	
MOLEX INCORPORATED				
THIS DRAWING CONTAINS INFORMATION THAT IS PROPRIETARY TO MOLEX INCORPORATED AND SHOULD NOT BE USED WITHOUT WRITTEN PERMISSION				

9 8 7 6 5 4 3 2 1

**PART NUMBERS FOR JACK WITH RIBS**

	TYPE PLAT'G	PACKA- GING	POS. 4	TOOLED	POS. 6	TOOLED	POS. 6	TOOLED	POS. 8	TOOLED	POS. 8	TOOLED	POS. 8	TOOLED
			4 CKTS.	4 CKTS.	6 CKTS.	4 CKTS.	6 CKTS.	8 CKTS.						
FINISH 2	TRAY		95022-2447	X	95022-2647	X	95022-2667	X	95022-2847		95022-2867		95022-2887	X
	TUBE		95022-2407	X	95022-2607	X	95022-2617	X	95022-2807		95022-2817		95022-2827	X
FINISH 7	TRAY		95022-.447		95022-.647		95022-.667		95022-.847		95022-.867		95022-.887	
	TUBE		95022-.407		95022-.607		95022-.617		95022-.807		95022-.817		95022-.827	

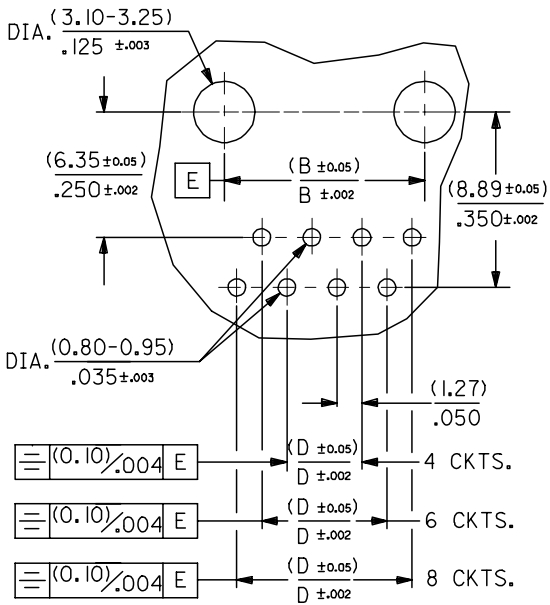

**PART NUMBERS FOR JACK WITHOUT RIBS**

	TYPE PLAT'G	PACKA- GING	POS. 4	TOOLED	POS. 6	TOOLED	POS. 6	TOOLED	POS. 8	TOOLED	POS. 8	TOOLED	POS. 8	TOOLED
			4 CKTS.	4 CKTS.	6 CKTS.	4 CKTS.	6 CKTS.	8 CKTS.						
FINISH 2	TRAY		95022-2441	X	95022-2641	X	95022-2661	X	95022-2841		95022-2861		95022-2881	
	TUBE		95022-2401	X	95022-2601	X	95022-2611	X	95022-2801		95022-2811		95022-2821	
FINISH 7	TRAY		95022-.441		95022-.641		95022-.661		95022-.841		95022-.861		95022-.881	
	TUBE		95022-.401		95022-.601		95022-.611		95022-.801		95022-.811		95022-.821	

**PART NUMBERS FOR JACK WITH SPLIT RIBS**

	TYPE PLAT'G	PACKA- GING	POS. 4	TOOLED	POS. 6	TOOLED	POS. 6	TOOLED	POS. 8	TOOLED	POS. 8	TOOLED	POS. 8	TOOLED
			4 CKTS.	4 CKTS.	6 CKTS.	4 CKTS.	6 CKTS.	8 CKTS.						
FINISH 2	TUBE		95022-2449	X	95022-2649		95022-2669	X	95022-2849		95022-2869		95022-2889	
FINISH 7	TUBE		95022-.449		95022-.649		95022-.669		95022-.849		95022-.869		95022-.889	

DIM.	TYPE	POS. 4	POS. 6		POS. 8		
		4 CKTS.	4 CKTS.	6 CKTS.	4 CKTS.	6 CKTS.	8 CKTS.
A		(11.18) / .440	(13.21) / .520	(13.21) / .520	(15.24) / .600	(15.24) / .600	(15.24) / .600
B		(7.62) / .300	(10.16) / .400	(10.16) / .400	(11.43) / .450	(11.43) / .450	(11.43) / .450
C	(WITH RIBS)	(14.00) / .551	(16.00) / .630	(16.00) / .630	(18.00) / .709	(18.00) / .709	(18.00) / .709
	(WITH SPLIT RIBS)	(14.00) / .551	(16.00) / .630	(16.00) / .630	(18.00) / .709	(18.00) / .709	(18.00) / .709
D		(3.81) / .150	(3.81) / .150	(6.35) / .250	(3.81) / .150	(6.35) / .250	(8.89) / .350
H		(7.82) / .308	(9.88) / .389	(9.88) / .389	(11.94) / .470	(11.94) / .470	(11.94) / .470
J		(5.64) / .222	(6.70) / .264	(6.70) / .264	(6.30) / .248	(6.30) / .248	(6.30) / .248
K		(3.07) / .121	(4.06) / .160	(4.06) / .160	(4.06) / .160	(4.06) / .160	(4.06) / .160

ENTER DESCRIPTION EC NO: MG2004-0207 DRAWN: GECHITENA 2004/08/26 CHKD: FCARABET 2004/08/31 APPR: KNOLLER 2004/09/08	QUALITY SYMBOLS ▽=0 ▽=0	GENERAL TOLERANCES (UNLESS SPECIFIED)		DIMENSION STYLE MM/IN		SCALE 4:1	DESIGN UNITS METRIC	THIRD ANGLE PROJECTION		
		4 PLACES	± ---	± ---	DRAWN BY DP	DATE 90/03/09	TITLE HIGH PROFILE TOP ENTRY JACK			
		3 PLACES	± ---	± .010	CHECKED BY FB	DATE 90/03/09				
		2 PLACES	± 0.25	± .014	APPROVED BY JB	DATE 90/03/09	MOLEX INCORPORATED			
1 PLACE	± 0.35	± ---	MATERIAL NO.		DOCUMENT NO.		SHEET NO.			
ANGULAR ± 2 °			DRAFT WHERE APPLICABLE MUST REMAIN WITHIN DIMENSIONS		SEE CHART		SDA-95022		2 OF 4	
THIS DRAWING CONTAINS INFORMATION THAT IS PROPRIETARY TO MOLEX INCORPORATED AND SHOULD NOT BE USED WITHOUT WRITTEN PERMISSION										