

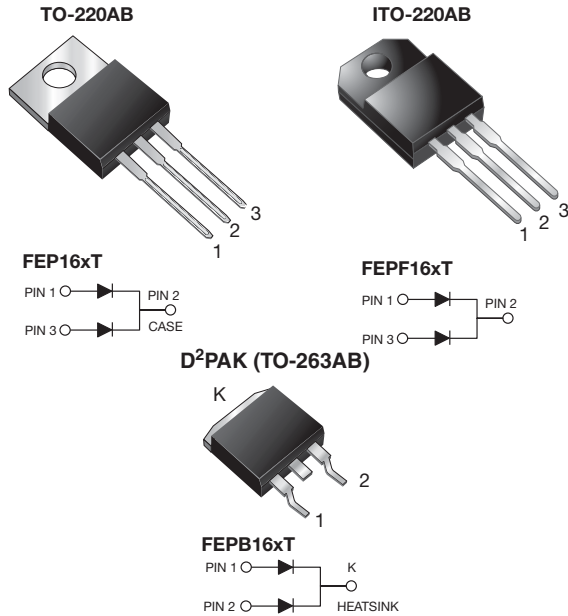

Dual Common Cathode Ultrafast Plastic Rectifier



FEATURES

- Power pack
- Glass passivated pellet chip junction
- Ultrafast recovery time
- Low switching losses, high efficiency
- High forward surge capability
- Meets MSL level 1, per J-STD-020, LF maximum peak of 245 °C (for TO-263AB package)
- Solder dip 275 °C max. 10 s, per JESD 22-B106 (for TO-220AB and ITO-220AB package)
- AEC-Q101 qualified (for ITO-220AB and TO-263AB package)
- Material categorization: for definitions of compliance please see www.vishay.com/doc?99912



RoHS COMPLIANT

TYPICAL APPLICATIONS

For use in high frequency rectifier of switching mode power supplies, inverters, freewheeling diodes, DC/DC converters, and other power switching application.

DESIGN SUPPORT TOOLS

[click logo to get started](#)



MECHANICAL DATA

Case: TO-220AB, ITO-220AB, D²PAK (TO-263AB)

Molding compound meets UL 94 V-0 flammability rating
Base P/N-E3 - RoHS-compliant, commercial grade
Base P/NHE3 - RoHS-compliant, AEC-Q101 qualified

Terminals: matte tin plated leads, solderable per J-STD-002 and JESD 22-B102

E3 suffix meets JESD 201 class 1A whisker test, HE3 suffix meets JESD 201 class 2 whisker test

Polarity: as marked

Mounting Torque: 10 in-lbs max.

PRIMARY CHARACTERISTICS	
$I_{F(AV)}$	2 x 8.0 A
V_{RRM}	50 V to 600 V
I_{FSM}	200 A, 125 A
t_{rr}	35 ns, 50 ns
V_F	0.95 V, 1.30 V, 1.50 V
T_J max.	150 °C
Package	TO-220AB, ITO-220AB, D ² PAK (TO-263AB)
Circuit configurations	Common cathode

MAXIMUM RATINGS ($T_C = 25\text{ °C}$ unless otherwise noted)										
PARAMETER	SYMBOL	FEP16AT	FEP16BT	FEP16CT	FEP16DT	FEP16FT	FEP16GT	FEP16HT	FEP16JT	UNIT
Maximum repetitive peak reverse voltage	V_{RRM}	50	100	150	200	300	400	500	600	V
Maximum RMS voltage	V_{RMS}	35	70	105	140	210	280	350	420	V
Maximum DC blocking voltage	V_{DC}	50	100	150	200	300	400	500	600	V
Maximum average forward rectified current at $T_C = 100\text{ °C}$	$I_{F(AV)}$	16								A
Peak forward surge current 8.3 ms single half sine-wave superimposed on rated load per diode	I_{FSM}	200				125				A
Operating storage and temperature range	T_J, T_{STG}	-55 to +150								°C



MAXIMUM RATINGS (T _C = 25 °C unless otherwise noted)										
PARAMETER	SYMBOL	FEP16AT	FEP16BT	FEP16CT	FEP16DT	FEP16FT	FEP16GT	FEP16HT	FEP16JT	UNIT
Isolation voltage (ITO-220AB only) from terminal to heatsink t = 1 min	V _{AC}	1500								V



ELECTRICAL CHARACTERISTICS (T _C = 25 °C unless otherwise noted)													
PARAMETER	TEST CONDITIONS		SYMBOL	FEP 16AT	FEP 16BT	FEP 16CT	FEP 16DT	FEP 16FT	FEP 16GT	FEP 16HT	FEP 16JT	UNIT	
Maximum instantaneous forward voltage per diode	8.0 A		V _F ⁽¹⁾	0.95			1.30		1.50			V	
Maximum DC reverse current per diode at rated DC blocking voltage	T _C = 25 °C		I _R	10								μA	
	T _C = 100 °C			500									
Maximum reverse recovery time per diode	I _F = 0.5 A, I _R = 1.0 A, I _{rr} = 0.25 A		t _{rr}	35			50					ns	
Typical junction capacitance per diode	4.0 V, 1 MHz		C _J	85					60				pF

Note

(1) Pulse test: 300 μs pulse width, 1 % duty cycle

THERMAL CHARACTERISTICS (T _C = 25 °C unless otherwise noted)					
PARAMETER	SYMBOL	FEP	FEPF	FEPB	UNIT
Typical thermal resistance from junction to case per diode	R _{θJC}	2.2	3.1	2.2	°C/W

ORDERING INFORMATION (Example)					
PACKAGE	PREFERRED P/N	UNIT WEIGHT (g)	PACKAGE CODE	BASE QUANTITY	DELIVERY MODE
TO-220AB	FEP16JT-E3/45	1.85	45	50/tube	Tube
ITO-220AB	FEPF16JT-E3/45	1.97	45	50/tube	Tube
TO-263AB	FEPB16JT-E3/45	1.35	45	50/tube	Tube
TO-263AB	FEPB16JT-E3/81	1.35	81	800/reel	Tape and reel
ITO-220AB	FEPF16JT <small>THE3</small> /45 ⁽¹⁾	1.97	45	50/tube	Tube
TO-263AB	FEPB16JT <small>THE3</small> /45 ⁽¹⁾	1.35	45	50/tube	Tube
TO-263AB	FEPB16JT <small>THE3</small> /81 ⁽¹⁾	1.35	81	800/reel	Tape and reel

Note

(1) AEC-Q101 qualified, available in ITO-220AB and TO-263AB package



RATINGS AND CHARACTERISTICS CURVES ($T_A = 25\text{ }^\circ\text{C}$ unless otherwise noted)

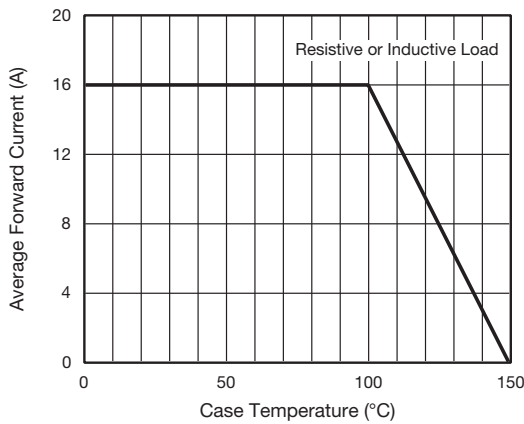

Fig. 1 - Forward Current Derating Curve

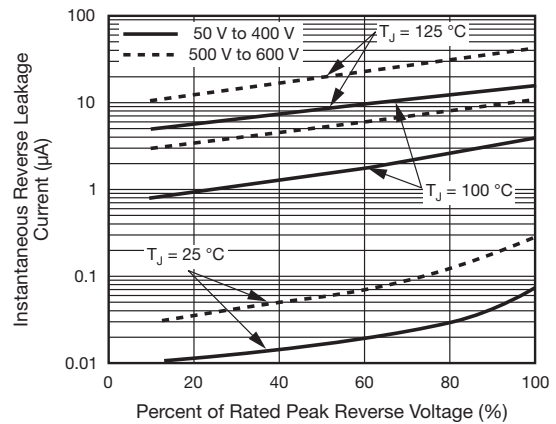

Fig. 4 - Typical Reverse Characteristics Per Diode

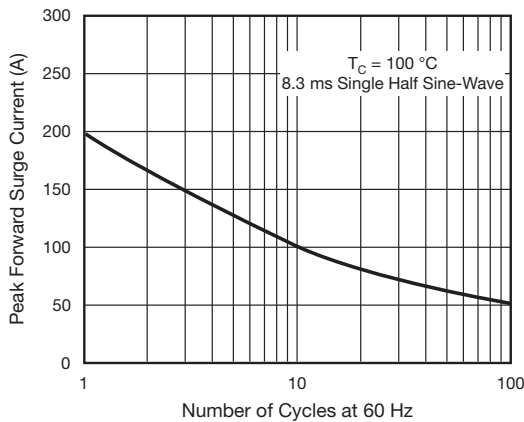

Fig. 2 - Maximum Non-Repetitive Peak Forward Surge Current Per Diode

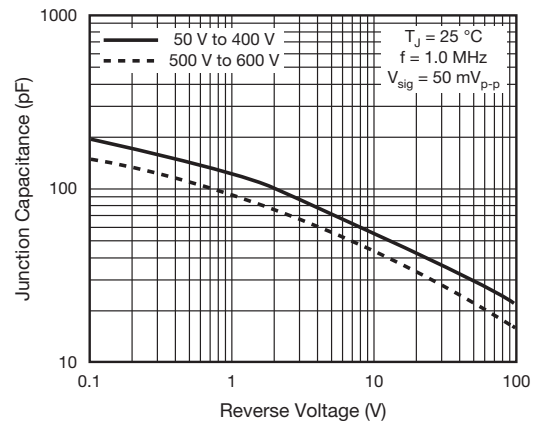

Fig. 5 - Typical Junction Capacitance Per Diode

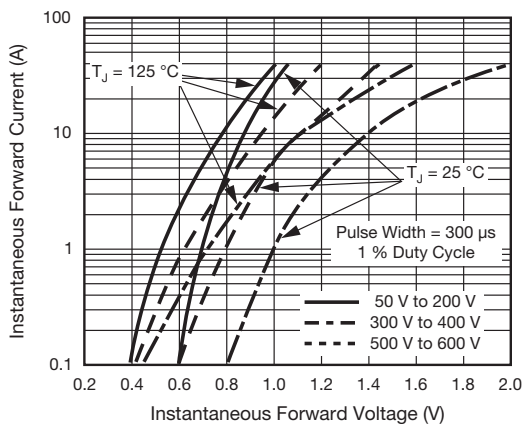
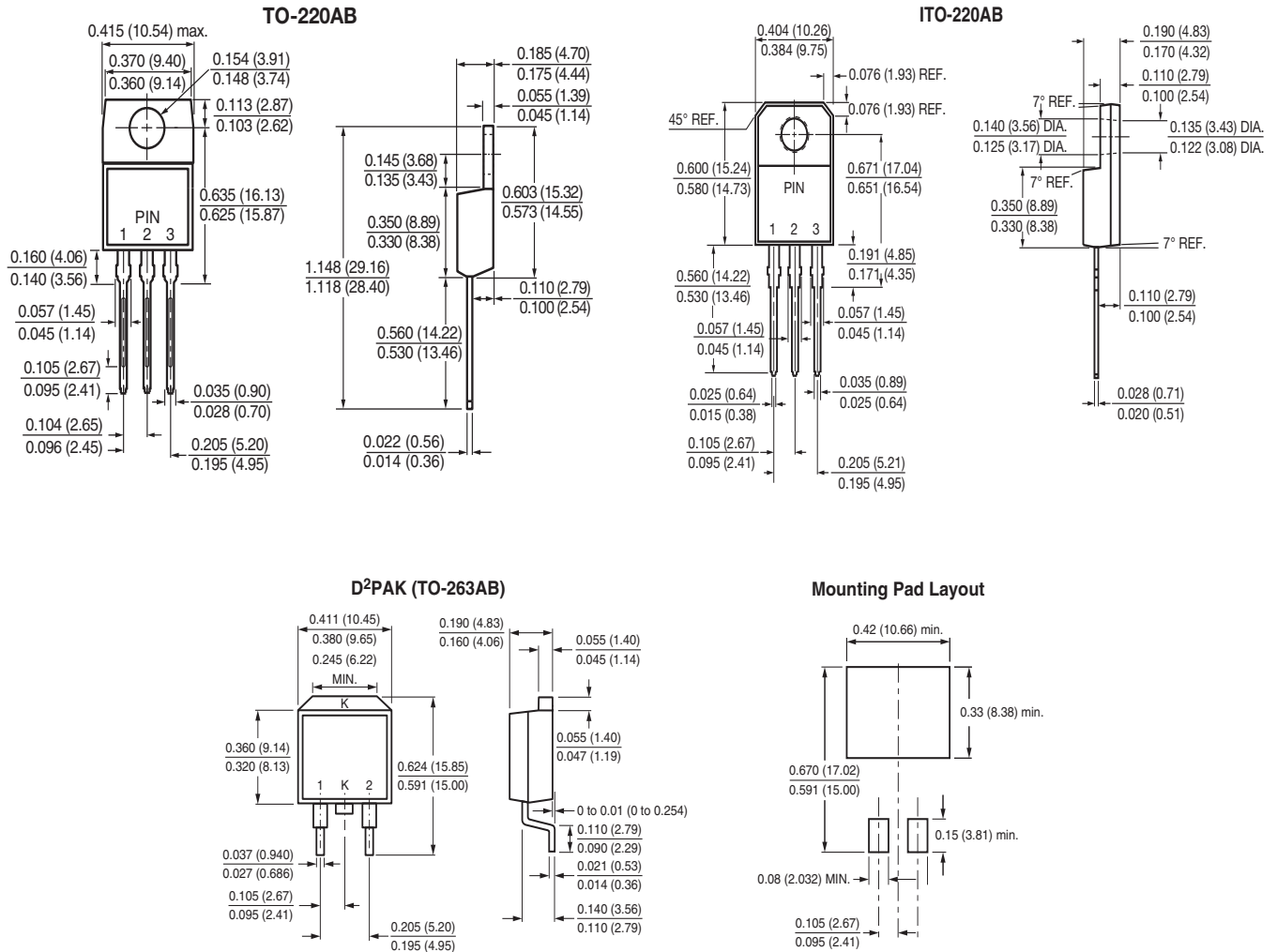

Fig. 3 - Typical Instantaneous Forward Characteristics Per Diode



PACKAGE OUTLINE DIMENSIONS in inches (millimeters)





Disclaimer

ALL PRODUCT, PRODUCT SPECIFICATIONS AND DATA ARE SUBJECT TO CHANGE WITHOUT NOTICE TO IMPROVE RELIABILITY, FUNCTION OR DESIGN OR OTHERWISE.

Vishay Intertechnology, Inc., its affiliates, agents, and employees, and all persons acting on its or their behalf (collectively, "Vishay"), disclaim any and all liability for any errors, inaccuracies or incompleteness contained in any datasheet or in any other disclosure relating to any product.

Vishay makes no warranty, representation or guarantee regarding the suitability of the products for any particular purpose or the continuing production of any product. To the maximum extent permitted by applicable law, Vishay disclaims (i) any and all liability arising out of the application or use of any product, (ii) any and all liability, including without limitation special, consequential or incidental damages, and (iii) any and all implied warranties, including warranties of fitness for particular purpose, non-infringement and merchantability.

Statements regarding the suitability of products for certain types of applications are based on Vishay's knowledge of typical requirements that are often placed on Vishay products in generic applications. Such statements are not binding statements about the suitability of products for a particular application. It is the customer's responsibility to validate that a particular product with the properties described in the product specification is suitable for use in a particular application. Parameters provided in datasheets and / or specifications may vary in different applications and performance may vary over time. All operating parameters, including typical parameters, must be validated for each customer application by the customer's technical experts. Product specifications do not expand or otherwise modify Vishay's terms and conditions of purchase, including but not limited to the warranty expressed therein.

Except as expressly indicated in writing, Vishay products are not designed for use in medical, life-saving, or life-sustaining applications or for any other application in which the failure of the Vishay product could result in personal injury or death. Customers using or selling Vishay products not expressly indicated for use in such applications do so at their own risk. Please contact authorized Vishay personnel to obtain written terms and conditions regarding products designed for such applications.

No license, express or implied, by estoppel or otherwise, to any intellectual property rights is granted by this document or by any conduct of Vishay. Product names and markings noted herein may be trademarks of their respective owners.